

IMPORTANT

READ CAREFULLY BEFORE USE

KEEP IN SAFE PLACE READY TO CONSULT AT LATER DATE



BOSCH

ZEMO 
DAS E-BIKE



Translation of the original operating instructions
for ZEMO pedelecs with pinion motor and
FIT Comfort display

ZE FS P12

ZA-15-0064

Contents

1	About these operating instructions	
1.1	Manufacturer	9
1.2	Laws, standards and directives	9
1.2.1	Warnings	9
1.2.2	Markups	9
1.3	For your information	9
1.4	Language	10
1.5	Aim of the operating instructions	10
1.6	Type number and model	11
1.7	Frame number	11
1.8	Identifying the operating instructions	11
2	Safety	
2.1	Residual risk	12
2.1.1	Risk of fire and explosion	12
2.1.2	Electric shock	14
2.1.3	Risk of a crash	14
2.1.4	Risk of amputation	14
2.1.5	Key breaking off	14
2.2	Toxic substances	15
2.2.1	Toxic substances	15
2.2.2	Irritants and corrosive substances	15
2.3	Requirements for the rider	15
2.4	Vulnerable groups	15
2.5	Personal protective equipment	16
2.6	Safety guards	16
2.7	Safety markings and safety instructions	16
2.8	What to do in an emergency	17
2.8.1	Dangerous situation in road traffic	17
2.8.2	Leaked brake fluid	17
2.8.3	Battery vapour emission	18
2.8.4	Battery fire	18
3	Description	
3.1	Proper use	19
3.1.1	Pedelec type	19
3.1.2	Improper use	19
3.1.3	Area of use as per EN 17406, from model year 2024	20
3.2	Technical data	21
3.2.1	Complete BOSCH vehicle	21
3.2.2	Dimensions	22
3.3	Nameplate	23
3.3.1	Model year 24	23
3.4	Components	24
3.4.1	Overview of city and trekking bicycle	24
3.4.2	Chassis	27
3.4.3	Wheel	41
3.4.4	Brake	46
3.4.5	Saddle	48
3.4.6	Seat post	50
3.4.7	Mechanical drive system	52
3.4.8	PINION electric drive system	53
3.4.9	Handlebars with FIT Remote Basic with FIT Comfort or FIT Compact display	55
3.4.10	Control panel	56
3.5	Description of controls and screens	57

3.5.1	Display	57
3.5.2	Handbrake	64
3.5.3	Gear shift	65
3.5.4	Suspension and damping	66
3.5.5	Indicators on the battery	70
3.6	Transportation	71
3.6.1	Using the transport securing system	71
3.6.2	Transporting the pedelec	71
3.6.3	Shipping a pedelec	72
3.6.4	Transporting the battery	72
3.6.5	Shipping the battery	72
3.7	Storing	73
3.7.1	Battery storage mode	73
3.7.2	Break in operation	73
5	Assembly	
5.1	Unpacking	74
5.2	Required tools	74
5.3	Commissioning	75
5.3.1	Checking the battery	75
5.3.2	Adjusting the LIMOTEC seat post	76
5.3.3	Preparing the wheel	77
5.3.4	Installing the wheel in the SUNTOUR fork	78
5.3.5	Checking the stem and handlebars	82
5.4	Selling the pedelec	82
5	Assembly instructions for online sales	
5.0.1	Unpacking	83
5.0.2	Preparing	83
5.0.3	Required tools	83
5.0.4	Straightening the handlebars	84
5.1	Stem with screw	84
5.1.1	Checking the stem and handlebars are in correct position	85
5.1.2	Fitting the pedals	86
6	Operation	
6.1	Risks and hazards	87
6.2	Tips for a greater range	89
6.3	Instruction and customer service	90
6.4	Adjusting the pedelec	90
6.4.1	Preparing	90
6.4.2	Determining the sitting position	91
6.4.3	Seat post	92
6.4.4	Saddle	92
6.4.5	Handlebars	99
6.4.6	Stem	101
6.4.7	Handles	103
6.4.8	Tyres	104
6.4.9	Brake	106
6.4.10	Control panel and gear shift	110
6.4.11	Suspension and damping	111
6.4.12	Adjusting the suspension fork sag	111
6.4.13	Adjusting the rear frame damper sag	113
6.4.14	Adjusting the suspension fork rebound damper	116
6.4.15	Adjusting the rear frame damper rebound damper	118
6.4.16	Riding light	120
6.4.17	Adjusting the on-board computer and FIT Compact	122
6.5	Accessories	127

6.5.1	Child seat	127
6.5.2	Trailer	128
6.5.3	Pannier rack	129
6.5.4	Panniers and cargo boxes	129
6.5.5	Front baskets	130
6.5.6	Bar ends	130
6.5.7	Kickstands	130
6.5.8	Additional battery headlight	130
6.5.9	Mobile holder	130
6.5.10	Suspension fork coil spring	130
6.5.11	Fixed weather protection systems	130
6.6	Personal protective equipment and accessories for road safety	131
6.7	Before each ride	131
6.8	Using the battery	132
6.8.1	Removing the battery	132
6.8.2	Inserting the battery	132
6.8.3	Charging the battery	133
6.8.4	Waking the battery	133
6.9	Straightening the quickly adjustable stem	134
6.10	Using the pannier rack	134
6.11	Raising the kickstand	135
6.12	Using the saddle	135
6.12.1	Using the leather saddle	135
6.13	Using the pedals	135
6.14	Setting the saddle height with the remote control	136
6.14.1	Lowering the saddle	136
6.14.2	Raising the saddle	136
6.15	Using the bell	136
6.16	Using the handlebars	136
6.16.1	Using multi-position handlebars	136
6.16.2	Using bar ends	137
6.16.3	Using leather handles	137
6.16.4	Adjusting the rear frame damper	138
6.16.5	Adjusting the rear frame damper compression damper	140
6.17	Electric drive system	141
6.17.1	Switching on the electric drive system	141
6.17.2	Switching off the electric drive system	141
6.18	Control panel	142
6.18.1	Using the push assist system	142
6.18.2	Selecting the level of assistance	143
6.19	Using the brake	144
6.19.1	Using the handbrake	144
6.19.2	Using the back-pedal brake	144
6.19.3	Using Pinion gears	145
6.20	Use suspension and damping	146
6.20.1	Locking the suspension	146
6.20.2	Adjusting the suspension fork compression damper	147
6.21	Parking	150
6.21.1	Screwing in the quickly adjustable stem	151
6.21.2	Folding up the pedal	151

7 Cleaning, maintenance and inspection

7.1	Before each ride	156
7.1.1	Checking the guards	156
7.1.2	Checking the frame	156
7.1.3	Checking the fork	156
7.1.4	Checking the rear frame damper	156
7.1.5	Checking the pannier rack	156
7.1.6	Checking the mudguards	156

7.1.7	Check wheel concentricity	156
7.1.8	Checking the quick releases	156
7.1.9	Checking the suspension seat post	157
7.1.10	Checking the bell	157
7.1.11	Checking the handles	157
7.1.12	Checking the USB cover	157
7.1.13	Checking the riding light	157
7.1.14	Checking the brake	157
7.2	After each ride	158
7.2.1	Cleaning the riding light and reflectors	158
7.2.2	Cleaning the suspension fork	158
7.2.3	Maintaining the suspension fork	158
7.2.4	Cleaning the pedals	158
7.2.5	Cleaning the brake	158
7.2.6	Cleaning the suspension seat post	158
7.2.7	Cleaning the rear frame damper	158
7.3	Basic cleaning	159
7.3.1	Cleaning the on-board computer and control panel	159
7.3.2	Cleaning the battery	159
7.3.3	Cleaning the motor	159
7.3.4	Cleaning the frame, fork, pannier rack, guards and kickstand	160
7.3.5	Cleaning the stem	160
7.3.6	Cleaning the handlebars	160
7.3.7	Cleaning the handles	160
7.3.8	Cleaning the seat post	160
7.3.9	Cleaning the saddle	161
7.3.10	Cleaning the tyres	161
7.3.11	Cleaning the spokes and spoke nipples	161
7.3.12	Cleaning the hub	161
7.3.13	Cleaning the switching elements	161
7.3.14	Cleaning the SRAM AXS rear derailleur	161
7.3.15	Cleaning the cassette, chain wheels and front derailleur	162
7.3.16	Cleaning the brake	162
7.3.17	Cleaning the brake disc	162
7.3.18	Cleaning the belt	162
7.3.19	Cleaning the chain	163
7.4	Maintenance	164
7.4.1	Maintain frame	164
7.4.2	Maintain fork	164
7.4.3	Maintain pannier rack	165
7.4.4	Maintain mudguard	165
7.4.5	Servicing the kickstand	165
7.4.6	Maintaining the stem	165
7.4.7	Maintaining the handlebars	165
7.4.8	Maintaining the handles	166
7.4.9	Maintaining the seat post	166
7.4.10	Maintaining the rims	166
7.4.11	Maintaining the leather saddle	166
7.4.12	Maintaining the hub	167
7.4.13	Maintaining the spoke nipples	167
7.4.14	Maintaining the gear shift	167
7.4.15	Maintaining the pedals	167
7.4.16	Maintaining the chain	168
7.4.17	Maintaining the battery	168
7.4.18	Maintaining the brake	169
7.4.19	Lubricating the Eightpins seat post tube	169
7.5	Inspection	170
7.5.1	Checking the wheel	170
7.5.2	Checking the brake system	174

7.5.3	Checking the belt	176
7.5.4	Checking the riding light	179
7.5.5	Checking the stem	180
7.5.6	Checking the handlebars	180
7.5.7	Checking the saddle	180
7.5.8	Checking the seat post	180
7.5.9	Checking the pedal	180
7.5.10	Checking the gear shift	181
8	Inspection and maintenance	
8.1	Initial inspection	184
8.2	Major inspection	184
8.3	Component-specific maintenance	184
8.4	Carrying out initial inspection	187
8.5	Perform major inspection	188
8.5.1	Inspect frame	195
8.5.2	Inspecting the pannier rack	195
8.5.3	Inspecting and maintaining the rear frame damper	195
8.5.4	Inspecting the gear hub	196
8.5.5	Inspecting the stem	196
8.5.6	Inspect and grease steering headset	196
8.5.7	Inspecting the axle with quick release	197
8.5.8	Inspecting the fork	198
8.5.9	Inspecting the seat post	199
8.5.10	Torque	201
9	Troubleshooting, fault clearance and repair	
9.1	Preventing pain	212
9.1.1	Sitting discomfort	213
9.1.2	Pain in hips	213
9.1.3	Backache	213
9.1.4	Pain in shoulders and nape of neck	214
9.1.5	Numb or aching hands	214
9.1.6	Pain in upper thigh	214
9.1.7	Knee pain	215
9.1.8	Pain in the foot	215
9.2	FIT drive system	216
9.2.1	The drive system or display do not start up	216
9.2.2	Warning messages and LEDs	216
9.2.3	Errors in the assistance system	216
9.2.4	Battery error	217
9.2.5	PINION error message	219
9.2.6	Correcting disc brake faults	231
9.2.7	Correcting faults in the SR SUNTOUR suspension fork	232
9.2.8	Correcting faults in the ROCKSHOX rear frame damper	236
9.2.9	Correcting freewheel faults	240
9.2.10	Correcting lighting faults	241
9.2.11	Correcting faults in tyres	241
9.2.12	Correcting control seat post faults	241
9.2.13	Correcting other faults and errors	242
9.3	Repairs at the specialist dealer	243
9.3.1	Original parts and lubricants	243
9.3.2	Repairing the frame	243
9.3.3	Repairing the suspension fork	243
9.3.4	Replacing the riding light	244
9.3.5	Adjusting the headlight	244
9.3.6	Checking suspension fork-tyre clearance	244

10	Recycling and disposal	
10.1	Guidelines on removal of waste	245
11	Documents	
11.1	Assembly report	247
11.2	Inspection and maintenance log	249
12	Glossary	
12.1	Abbreviations	256
12.2	Simplified terms	256
13	Appendix	
I.	Translation of the original EC/EU Declaration of Conformity	257
14	Keyword index	

Thank you for your trust!

ZEMO pedelecs are premium quality bicycles. You have made an excellent choice. Your specialist dealer will provide you with guidance and instruction and assemble your product. Your specialist dealer will also be happy to assist you in the future, whether you require maintenance, a retrofit or repair.

Your new pedelec comes with these operating instructions. Please take time to become familiar with your new pedelec and follow the tips and suggestions in the operating instructions. They will help you to enjoy your pedelec for a long time to come. We hope you have fun and wish you well on all of your rides!

Download the operating instructions onto your phone at the following link, so that you can use them when you are out riding:

<https://www.zemo.com/de/de/index/download.html>.



Copyright

© ZEG Zweirad-Einkaufs-Genossenschaft eG

Distribution or reproduction of these operating instructions and utilisation or communication of their content is prohibited unless expressly approved. Anyone who does not comply with these restrictions is liable for compensation. All rights reserved in the event that a patent, utility model or industrial design is registered.

Subject to internal changes

The information contained in these *operating instructions* are the approved technical specifications at the time of printing. In addition to the functions described here, the software may be modified at any time to rectify errors and extend functions.

Any significant changes are included in a new published version of the operating instructions. All changes and new versions of the operating instructions are published on the following website:

<https://www.zemo.com/de/de/index/download.html>

Editing

Text and images:
ZEG Zweirad-Einkaufs-Genossenschaft eG
Longericher Strasse 2
50739 Köln
Germany

Translation

ElaN Languages
Bahnhofstrasse 27
78713 Schramberg
Germany

Contact if you have any questions or problems, or wish to have a printed copy of these operating instructions:

tecdoc@zeg.de

1 About these operating instructions

1.1 Manufacturer

ZEG Zweirad-Einkaufs-Genossenschaft eG
 Longericher Strasse 2
 50739 Köln
 Germany

Tel.: +49 221 17959 0
 Fax: +49 221 17959 31
 E-mail: info@zemo.com

1.2 Laws, standards and directives

The operating instructions comply with the essential requirements specified in:

- Machinery Directive 2006/42/EC
- RoHS Directive 2011/65/EU Restriction of the use of certain hazardous substances in electrical and electronic equipment
- Electromagnetic Compatibility Directive 2014/30/EU
- Low Voltage Directive 2014/35/EU met in compliance with Appendix I, no. 1.5.1 of the Machinery Directive 2006/42/EC
- EN 15194:2017 Cycles – Electrically power assisted cycles – EPAC bicycles
Except Section 6 Instructions for Use; harmonised standard EN ISO 20607:2019 used in its place
- EN ISO 20607: 2019 Safety of machinery – Instruction handbook – General drafting principles.

1.2.1 Warnings

Warnings indicate hazardous situations and actions. You will find three categories of warnings in the operating instructions:



May lead to serious or even fatal injuries if ignored. Medium-risk hazard.



May lead to minor or moderate injuries if ignored. Low-risk hazard.



May lead to material damage if ignored.

1.2.2 Markups

You will find ten text markups in the operating instructions:

Stylised form	Use
<u>Underlined in blue</u>	Link
<u>Underlined in grey</u>	Cross references
✓	Requirements
▶	Instructions for actions with no specific order
6	Instructions for actions in specified order
⇒	Result of the action
SPACED	Indicators on the display screen
•	Bulleted lists
Only applies to pedelecs with this equipment	A notice beneath the heading indicates components which can be used as an option

Table 72: Markups

1.3 For your information

Different icons are used to make things easier to read.

	Text for specialist dealers
	Notice on replacing components
	Notice on fitness

1.4 Language

The original operating instructions are written in German. A translation is invalid without the original operating instructions.

1.5 Aim of the operating instructions

These operating instructions are an integral part of the pedelec. Therefore, if the pedelec is re-sold at a later time, they must be handed over to the next owner.

The operating instructions aim to provide users with the information they need to use their pedelec effectively and safely throughout its entire lifecycle while also identifying reasonably foreseeable misuse.

The operating instructions are designed for pedelecs that are sold online. As a result, there is no need for instruction from a specialist dealer.

Paragraphs with a white background are intended to enable non-professionals to make safe settings on the pedelec, use it, clean it and identify and eliminate any faults.



Sections intended for technical staff are highlighted in blue and marked with a spanner symbol. Technical staff are trained bicycle mechanics, bicycle mechatronics engineers or similar.

These sections aim to allow technical staff to carry out initial assembly, commissioning, adjustments, inspections and repairs safely.

Technical staff also need to read all sections for pedelec riders and operators to ensure they can provide excellent customer service.

Always fill out all reports in Section 11.1 and Section 11.2 when carrying out work.

Section		Rider	Specialist dealer
1	About these operating instructions	<input type="checkbox"/>	<input type="checkbox"/>
2	Safety	<input type="checkbox"/>	<input type="checkbox"/>
3	Description	<input type="checkbox"/>	<input type="checkbox"/>
4	Transporting and storing	<input type="checkbox"/>	<input checked="" type="checkbox"/>
5.1	Assembly Assembly by specialist dealer	<input checked="" type="checkbox"/>	<input checked="" type="checkbox"/>
5.2	Assembly by end customer	<input type="checkbox"/>	<input checked="" type="checkbox"/>
6	Operation	<input type="checkbox"/>	<input checked="" type="checkbox"/>
7	Cleaning, maintenance and inspection	<input type="checkbox"/>	<input type="checkbox"/>
8	Inspection and maintenance	<input type="checkbox"/>	<input type="checkbox"/>
9.1	Preventing pain	<input type="checkbox"/>	<input type="checkbox"/>
9.2	Troubleshooting and fault clearance	<input type="checkbox"/>	<input type="checkbox"/>
9.8	Repair	<input checked="" type="checkbox"/>	<input checked="" type="checkbox"/>
10	Recycling and disposal	<input type="checkbox"/>	<input type="checkbox"/>
11	Documents	<input checked="" type="checkbox"/>	<input type="checkbox"/>
12	Glossary	<input type="checkbox"/>	<input type="checkbox"/>
13	Appendix	<input checked="" type="checkbox"/>	<input checked="" type="checkbox"/>
14	Keyword index	<input type="checkbox"/>	<input type="checkbox"/>

Table 73: Target groups-section matrix

1.6 Type number and model

These operating instructions are an integral part of pedelecs with the type numbers:

Type no.	Model	Pedelec type
ZA-15-0064	ZE FS P12	City and trekking bicycle

Table 74: Type number, model and pedelec type

1.7 Frame number

Each frame has an individual frame number stamped on it (see Figure 2). The frame number can be used to link the pedelec with the owner. The frame number is the most important identifier for verifying ownership.

1.8 Identifying the operating instructions

The operating instructions identification number is located in bottom left-hand corner of each page.

The identification number is composed of the document number, the version number and the release date.

Identification number	MY23Z12 - 12_1.0_26.01.2024
------------------------------	-----------------------------

2 Safety

2.1 Residual risk

Pedelecs pose the following residual risks:

- Risk of fire and explosion
- Electric shock
- Risk of a crash
- Risk of amputation
- Key breaking off
- Malfunctions due to Bluetooth®



2.1.1 Risk of fire and explosion

Never charge if there is a critical fault

If a charger is connected to the drive system when a critical error is reported, the battery may be damaged permanently and may catch fire.

- ▶ Connect charger to fault-free electric drive system only.

Protect against penetrating water

The battery is only protected from spray water. Penetration by water can cause a short circuit. The battery may self-ignite and explode.

- ▶ Never immerse battery in water.
- ▶ Take battery out of service if you suspect water has penetrated it.

Avoid heat

Temperatures over 60 °C can also cause liquid to leak from the battery and the battery will become damaged. The battery may self-ignite and explode.

- ▶ Protect the battery against heat.
- ▶ Never store next to hot objects.
- ▶ Never expose battery to continuous direct sunlight.
- ▶ Avoid wide temperature fluctuations.

Never use incorrect charger

Chargers with excessive voltage damage batteries. This may cause a fire or an explosion.

- ▶ Only use approved batteries to charge.

Prevent short circuit due to interconnection

Metal objects may interconnect the battery's electrical terminals. The battery may self-ignite and explode.

- ▶ Never insert paper clips, screws, coins, keys and other small parts into the battery.
- ▶ Place the battery on clean surfaces only. Prevent charging socket and contacts against contamination from dirt, sand and similar.

Handling a damaged or faulty battery

Faulty batteries are hazardous goods. These include:

- Cells or batteries which have been identified as faulty for safety reasons;
- Batteries which have leaked or discharged gas;
- Cells or batteries which have sustained external or physical damage;
- Cells or batteries which have not yet undergone a safety test.

The safety electronics may fail if the batteries are damaged or faulty. The residual voltage can cause a short circuit. The battery may self-ignite and explode.

- ▶ Only use and charge battery and accessories if they are in perfect condition.
- ▶ Never open or repair the battery.
- ▶ Batteries with external damage must be removed from service immediately.
- ▶ If a battery is dropped or struck, remove it from service and keep it under observation for at least 24 hours.
- ▶ Contact specialist dealer.

Storing faulty batteries

Your specialist dealer will dispose of faulty batteries.

▶ Take faulty batteries to your specialist dealer.



▶ Store the battery in a safety container in a dry place as per special regulations (ADR SV 376, P908) until you dispose of it.



Figure 1: Example of a safety container

- ▶ Never store near flammable substances.
- ▶ Dispose of faulty batteries in the correct manner.

Avoid overheating in the charger

The charger heats up when charging the battery. If the battery is not allowed to cool down sufficiently, it can cause a fire or burns to the hands.

- ▶ Never use charger on a highly flammable surface.
- ▶ Never cover the charger during charging.
- ▶ Never leave battery unattended during charging.

Cool down overheated brakes and motors

The brakes and the motor may become very hot during operation. There is a risk of burns or fire in case of contact.

- ▶ Never touch the brakes or the motor immediately after a ride.
- ▶ Never place the pedelec on a flammable surface, such as grass or wood, directly after use.



2.1.2 Electric shock

Never use damaged network components

Damaged chargers, cables and plug connectors increase the risk of electric shock.

- ▶ Check the charger, cable and plug connector before each use. Never use a damaged charger.

Avoid water penetrating

If water penetrates into the charger, there is a risk of electric shock.

- ▶ Use the charger indoors only.

Dealing with condensate

Condensation may form in the charger and in the battery when the temperature changes from cold to hot, causing a short circuit.

- ▶ Wait until both charger and battery are at room temperature before connecting them.



2.1.3 Risk of a crash

Set the quick release correctly

Excessively high clamping force will damage the quick release and cause it to lose its function. Insufficient clamping force will result in unfavourable transmission of force. This can cause components to break. This will cause a crash with injuries.

- ▶ Never fasten a quick release using a tool (e.g. hammer or pliers).
- ▶ Only use the clamping lever with the specified set clamping force.

Use correct torque

If a screw is fastened too tightly, it may break. If a screw is not fastened enough, it may loosen. This will cause a crash with injuries.

- ▶ Always observe the indicated tightening torque on the screw or in Section 3.5.

Use approved brakes only

The wheels are designed exclusively for use with rim brakes or disc brakes. The wheel may break if an incorrect brake is used. This will cause a crash with injuries.

- ▶ Only use the approved brakes on the wheel.



2.1.4 Risk of amputation

The brake disc in disc brakes is so sharp that it can cause serious injuries to fingers if they are inserted into the brake disc openings.

The chain wheels and belt sprockets can draw in fingers, thus causing serious injuries to fingers.

- ▶ Always keep fingers well away from rotating brake discs and the chain or belt drive.

2.1.5 Key breaking off

If you leave a key inserted when riding or transporting the pedelec, it may break off or the locking system may open accidentally.

- ▶ Pull the key from the battery lock.

2.2 Toxic substances

If substances are released or used which pose a risk to people and the environment, effective protective measures must be taken.

Possible hazards, contamination and health hazards due to:

- Carcinogenic, germ-cell-mutagenic and reproduction-toxic substances
- Toxic substances
- Irritants (skin, respiratory system) and corrosive substances

What might happen?

- Serious harmful effects to health
- Threat to life
- Hazard to bystanders due to carry-over and contamination, including in personal sphere



2.2.1 Toxic substances

Toxic substances (also known as poison or toxins) refer to substances which can cause damage to living beings if they enter the organism above a specific low dose. The more the ingested amount of a toxic substance increases, the greater the likelihood of damage to health due to poisoning is. This can lead to death.

Brake fluid

Brake fluid may leak out after an accident or due to material fatigue. Brake fluid can be fatal if swallowed or inhaled.

- ▶ Never dismantle the brake system.
- ▶ Avoid contact with skin.
- ▶ Do not inhale vapours.



2.2.2 Irritants and corrosive substances

Corrosive substances (also known as corrosives) destroy living tissue or attack surfaces. Corrosive substances may be in solid, liquid or gaseous form.

Irritants are hazardous substances which irritate the skin and mucous membranes once you come into contact with them. This may cause inflammation of the affected areas.

Defective battery

Liquids and vapours may leak from damaged or faulty batteries. Excessively high temperatures may also cause liquids and vapours to leak from the battery. Such liquids and vapours can irritate the airways and cause burns.

- ▶ Never dismantle the battery.
- ▶ Avoid contact with skin.
- ▶ Never inhale vapours.

2.3 Requirements for the rider

The rider must have adequate physical, motor and mental abilities to ride on public roads. A minimum age of 14 years is recommended.

2.4 Vulnerable groups

- ▶ Keep batteries and the charger away from children and people with reduced physical, sensory or mental capacities or lacking in experience and knowledge.
- ▶ Children and young people must be provided with comprehensive instructions by a legal guardian.

2.5 Personal protective equipment

- ▶ Wear a suitable helmet. The helmet must have a reflective strip or a light in a clearly visible colour.
- ▶ Wear sturdy shoes.
- ▶ Wear clothing which is as bright or retroreflective as possible. Fluorescent materials are also suitable. High-visibility jackets and straps on your upper body ensure even greater safety. Never wear a skirt. Always wear trousers which reach down to your ankles instead.
- ▶ Wear gloves when it is cold.

2.6 Safety guards

Three safety guards on the pedelec protect riders against heat or moving parts:

- Chain or belt guards prevent clothing from being pulled into the drive train.
 - The motor cover on the motor casing protects against heat.
 - Mudguards protect against dirt and water splashing up from the road.
- ▶ Never remove the guards.
 - ▶ Check the guards on a regular basis.
 - ▶ Take pedelec out of service if a guard is damaged or missing. Contact specialist dealer.

2.7 Safety markings and safety instructions

Pedelec and battery nameplates contain the following safety markings and safety instructions:



Symbol	Explanation
	General warning
	Adhere to the instructions for use

Table 75: Safety markings











Symbol	Explanation
	Read the instructions
	Separate collection of electrical and electronic devices
	Separate collection of ordinary and rechargeable batteries
	Must not be thrown into fire (burning prohibited)
	It is forbidden to open any batteries
	Device of protection class II
	Only suitable for use indoors
	Fuse (device fuse)
	EU conformity
	Recyclable material
	Protect from temperatures above 50 °C and direct sunlight

Table 76: Safety instructions

2.8 What to do in an emergency

2.8.1 Dangerous situation in road traffic

- ▶ If you encounter any hazards or dangers in road traffic, apply the brake on the pedelec until it comes to a halt. The brake acts as an emergency stop system in such cases.

2.8.2 Leaked brake fluid

- ▶ Remove those affected from the danger area to fresh air.
- ▶ Never leave those affected unattended.
- ▶ Immediately remove any clothing items contaminated with brake fluid.
- ▶ Never inhale vapours. Ensure sufficient ventilation.
- ▶ Wear gloves and safety glasses as protective equipment.
- ▶ Keep unprotected persons away.
- ▶ Take care with leaked brake fluid as it poses a slip hazard.
- ▶ Keep leaked brake fluid away from naked flames, hot surfaces and sources of ignition.
- ▶ Avoid contact with skin and eyes.

If inhaled

- 1 Take in fresh air.
- 2 Immediately consult a doctor in case of any discomfort.

After skin contact

- 1 Wash affected skin with soap and water and rinse well.
- 2 Remove contaminated clothing.
- 3 Consult doctor in the event of pain or discomfort.

After contact with eyes

- 1 Rinse eyes under flowing water for at least ten minutes with the lids open; also rinse under lids.
- 2 Immediately consult a doctor in case of any pain or discomfort.

If swallowed

- 1 Rinse out mouth with water. Never induce vomiting. Risk of aspiration.
- 2 If a person is lying on their back and vomiting, place them in the recovery position.
- 3 Seek medical advice immediately.

Environmental protection measures

- ▶ Never allow brake fluid to flow into sewage, water courses or groundwater.
- ▶ Notify the relevant authorities if fluid penetrates the ground, water courses or the sewage system.
- ▶ Dispose of leaked brake fluid in an environmentally responsible way in accordance with statutory regulations (see Section 10.1).
- ▶ The brake system must be repaired immediately if brake fluid leaks out. Contact specialist dealer.

2.8.3 Battery vapour emission

Vapours may be emitted if the battery is damaged or used improperly. The vapours may cause respiratory tract irritation.

- 1 Get into fresh air.
- 2 Consult doctor in the event of pain or discomfort.

After contact with eyes

- 1 Carefully rinse eyes with plenty of water for at least 15 minutes. Protect unaffected eye.
- 2 Seek medical advice immediately.

After skin contact

- 1 Remove any solid particles immediately.
- 2 Remove contaminated clothing immediately.
- 3 Rinse the affected area with plenty of water for at least 15 minutes.
- 4 Then dab the affected skin gently. Do not rub dry.
- 5 Immediately consult a doctor if there is any redness, pain or discomfort.

2.8.4 Battery fire

The safety electronics may fail if the battery is damaged or faulty. The residual voltage can cause a short circuit. The battery may self-ignite and explode.

- 1 Keep your distance if the battery becomes deformed or starts to emit smoke.
- 2 If charging, remove the plug connector from the socket.
- 3 Contact the fire service immediately.
 - ▶ Use Class fire extinguishers to put out the fire.
 - ▶ Never extinguish damaged batteries with water or allow them to come into contact with water.

Inhaling vapours can cause intoxication.

- ▶ Stand on the side of the fire where the wind is blowing from.
- ▶ Use breathing apparatus if possible.

3 Description

3.1 Proper use

All checklists and instructions for actions in these operating instructions met. Approved accessories can be installed by specialist staff.

Use the pedelec when it is in perfect, proper working order only. National requirements may apply to the pedelec which the standard equipment may not meet. Different regulations apply across the country to the riding light,

3.1.1 Pedelec type

Each pedelec is assigned a pedelec type, which determines its proper use, function and area of use.

3.1.2 Improper use

Failure to adhere to the proper use poses a risk of personal injury and material damage. It is prohibited to use the pedelec in the following ways:

- when the electrical drive system been manipulated
- changing, eliminating or effacing frame numbers, nameplates or component serial numbers, or manipulating them in any other way
- riding with a damaged or incomplete pedelec
- riding over steps
- riding through deep water
- charging with an incorrect charger
- lending the pedelec to untrained pedelec rider
- carrying other people
- riding with excessive baggage

reflectors and other components when riding on public roads. The general laws and the regulations for the prevention of accidents and environmental protection in the respective country of use must be adhered to.

The rechargeable batteries are designed to supply power to the pedelec motor only. Never use the batteries for other purposes.

City and trekking bicycle



City and trekking bicycles are designed for comfortable, daily use and are suitable for riding on public roads.

Table 77: Proper use

- riding with no hands
- riding on ice and snow
- improper servicing
- improper repair
- tough areas of use, such as professional competitions
- acrobatics, riding up ramps, stunt riding or flying stunts.

City and trekking bicycle



City and trekking bicycles are not sports bicycles. If used for sports, the rider can expect reduced riding stability and diminished comfort.

Table 78: Improper use

3.1.3 Area of use as per EN 17406, from model year 2024







	Area of use	Average speed [km/h]	Unsuitability
 1 EN 17406	Use on normal, paved surfaces where the tyres should maintain contact with the ground at average speed with occasional jumps.	15 ... 25	<ul style="list-style-type: none"> • Never ride off road. • Never perform jumps over 15 cm.
 2 EN 17406	The area of use specified in Condition 1 applies. The vehicle can also be used on unpaved roads and gravel paths with moderate upward and downward slopes. Under these conditions, the bike may come into contact with uneven terrain and tyres may lose contact with the ground repeatedly.	15 ... 25	<ul style="list-style-type: none"> • Never ride off road. • Never perform jumps over 15 cm.
 3 EN 17406	The area of use specified in Condition 2 applies. The vehicle can also be used on rough paths, bumpy roads, difficult terrain and undeveloped tracks. Practice and technical skill is required for such rides.	Not relevant	<ul style="list-style-type: none"> • Never perform jumps over 60 cm. • Never use vehicle without practice. • Never use vehicle if you have no technical skills.
 4 EN 17406	The area of use specified in Condition 3 applies. The vehicle can also be used on descents on unpaved tracks at speeds up to 40 km/h.	Not relevant	<ul style="list-style-type: none"> • Never perform jumps over 120 cm. • Never use vehicle without practice. • Never use vehicle if you have no technical skills and are unable to handle a bike.
 5 EN 17406	The area of use specified in Condition 4 applies. The vehicle can also be used for extreme jumps or descents on unpaved tracks at speeds of more than 40 km/h or for a combination of the two.	Not relevant	<ul style="list-style-type: none"> • Never use vehicle without practice. • Never use vehicle if you have no extreme technical skills and are unable to handle the bike.
 6 EN 17406	The area of use specified in Condition 1 applies. The vehicle can also be used in competitions or for other purposes at speeds of more than 50 km/h (e.g. descents or sprints).	30 ... 55	<ul style="list-style-type: none"> • Never ride off road. • Never perform jumps over 15 cm. • Never use vehicle without practice. • Never use vehicle if you have no technical skills.

Table 79: Area of use, average speed and unsuitability

3.2 Technical data

3.2.1 Complete BOSCH vehicle

Power output/system	250 W (0.25 kW)
Shut-off speed	25 km/h
Service life	7 years
Weight	See Section 3.1.3
PTW	See Section 3.1.4

Table 80: Pedelec technical data

3.2.1.1 Emissions

The safety requirements as per Electromagnetic Compatibility Directive 2014/30/EU have been met. The pedelec and the charger can be used in residential areas without restriction.

A-weighted emission sound pressure level	< 70 dB(A)
Total vibration level for the hands and arms	< 2.5 m/s ²
Highest effective value of weighted acceleration for the entire body	< 0.5 m/s ²

Table 81: Emissions from the pedelec

3.2.1.2 Environmental requirements

You can ride the pedelec within a temperature range between -5 °C and +40 °C. The electric drive system is limited in its performance outside this temperature range.

Operating temperature	-5 °C ... +40 °C
-----------------------	------------------

During winter use, especially at temperatures below 0 °C, we recommend that you don't insert a battery charged and stored at room temperature into the pedelec until just before setting off. We recommend using thermal protection sleeves when riding longer distances at low temperatures.

Temperatures under -10 °C and over +60 °C must be avoided as a general rule. Never put the battery in a car in summer or store it in direct sunlight.

You must also keep within the following temperature ranges:

Transportation temperature	+10 °C ... +40 °C
Storage temperature	+10 °C ... +40 °C
Work environment temperature	+15 °C ... +25 °C
Charging temperature	+10 °C ... +40 °C

The nameplate contains symbols for the pedelec's area of use.

- Check what tracks and roads you may ride on before setting off for the first time.

3.2.2 Dimensions

The pedelec may only be loaded to its *maximum permitted total weight* (PTW).

The maximum permitted total weight is

- the weight of the fully assembled pedelec
- plus body weight
- plus baggage

Type no.	Model	PTW [kg]	max Driver Weight [kg]
ZA-15-0064	ZE FS P12	150	120

Table 82: Type number, model and PTW

3.3 Nameplate

3.3.1 Model year 24

The nameplate is situated on the *frame*. The precise position of the nameplate is shown in Figure 3.

The nameplate contains up to twelve pieces of information.

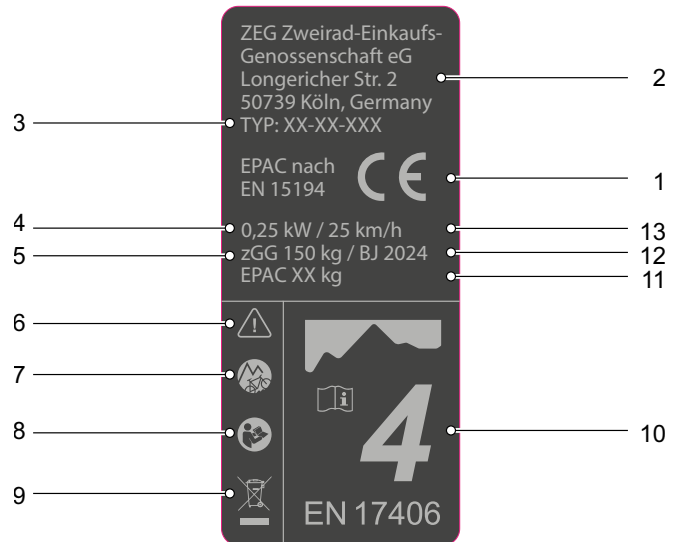

Figure 2: Example of ZEG nameplate

No.	Designation	Description	More information
1	CE marking	The manufacturer uses the CE marking to declare that the pedelec complies with applicable requirements.	Section 13
2	Hersteller	You can contact the manufacturer at the address indicated.	Section 1.1
3	Type number	All pedelec models have an eight-digit type number, which is used to specify the design model year, the type of pedelec and the version.	Section 1.6
4	Maximum continuous power rating	The maximum continuous power rating is the greatest possible power for the electric motor output shaft over 30 minutes.	...
5	Maximum permitted total weight (PTW)	The maximum permitted total weight is the weight of the fully assembled pedelec with the body weight plus the baggage.	Section 3.2.6
6	Safety markings and safety instructions	Safety markings warn of hazards.	Section 2.7
7	Pedelec type	Each pedelec is assigned a pedelec type, which determines its proper use, function and area of use.	Section 1.1
9	Disposal instructions	Follow the guidelines on waste disposal when disposing of the pedelec.	Section 10.1
10	Area of use as per EN 17406, from model year 2024	Ride pedelec in permitted locations only.	Section 3.1.3
11	Weight of the ready-to-ride pedelec (optional; only for pedelecs 25 kg or more)	The weight of the ready-to-ride pedelec is specified as a weight of 25 kg or above and refers to its weight at the time of purchase. Any extra accessories need to be added to the weight.	Section 3.2.5
12	Year of manufacture	The year of manufacture is the year in which the pedelec was manufactured.	...
13	Shut-off speed	The speed that the pedelec reaches at the moment when the current has dropped to zero or to the no-load current value.	...

Table 83: Explanation of information on the nameplate

3.4 Components

3.4.1 Overview of city and trekking bicycle

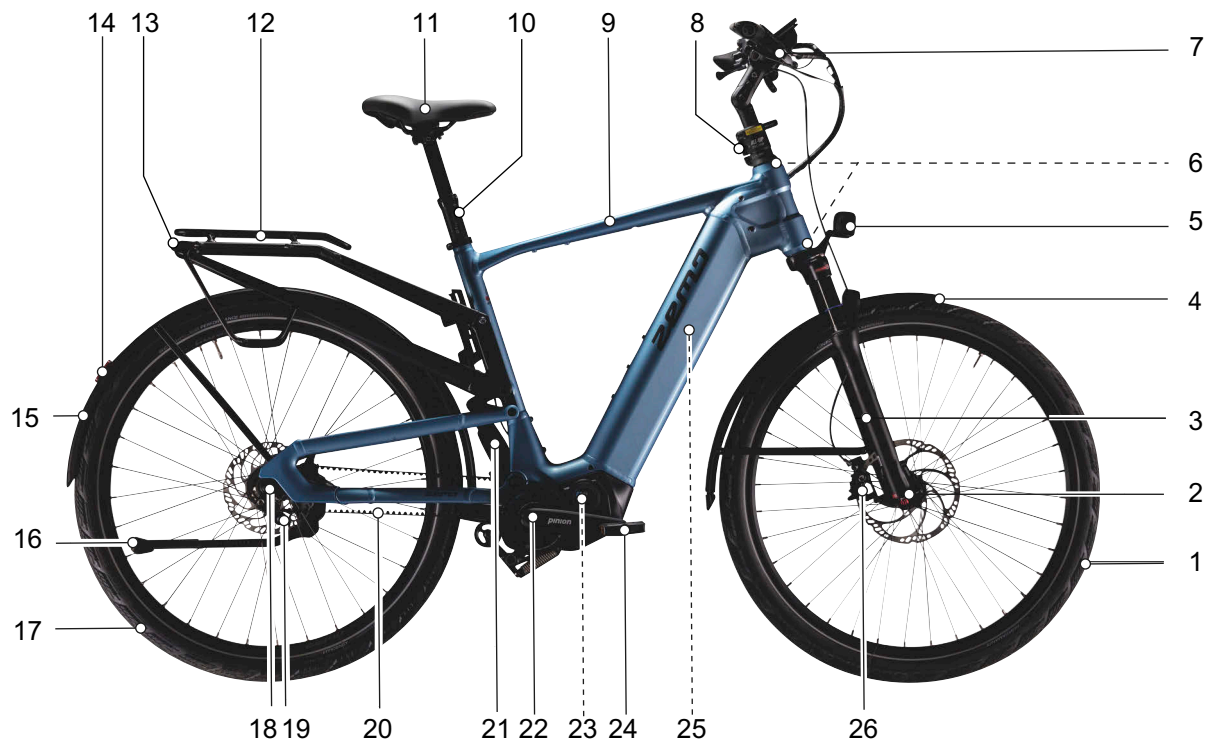

Figure 3: Pedelec viewed from the right, example

1	Wheel	10	Seat post	19	Rear wheel brake
2	Hub	11	Saddle	20	Belt
3	Suspension fork	12	Pannier rack	21	Rear frame damper
4	Guard	13	Rear light	22	Crank
5	Front light	14	Guard	23	Motor
6	Steering headset	15	Reflector	24	Pedal
7	Handlebars	16	Stand	25	Rechargeable battery
8	Stem	17	Wheel	25	Nameplate
9	Frame	18	Hub	26	Front wheel brake

3.4.1.1 Components and repair parts for ZE FS P12

ZA-15-0064

Diamant, Wave

Frame	ZEMO, ZE FS P12	Shape: Diamant, frame size: 45 cm
		Shape: Diamant, frame size: 50 cm
		Shape: Diamant, frame size: 55 cm
		Shape: Diamant, frame size: 60 cm
		Shape: Wave, frame size: 45 cm
		Shape: Wave, frame size: 50 cm
		Shape: Wave, frame size: 55 cm
Rear frame damper	ROCKSHOX, Deluxe Select+ (RS-DLX-SEL)	Installation length: 170 mm × 35 mm, damper: R
Tyres	SCHWALBE, Marathon Efficiency	Size: ETRTO 55-622 (28 × 2.35 inches); version: Super Race, V-Guard
Tube	SCHWALBE, AV19 (27.5"/28"/29")	Valve: AV; valve length: 40 mm; size: ETRTO 40/62-584/ 635; version: Standard
Rim band	TAPIR, 6781	Size: 8 mm × 2000 mm; thickness: 0.30 mm, colour: Yellow
Rim	RODI, Blackrock 25 29"	32H
Spoke	MACH1, Plus	14G, Ø: 2 mm; length: 294 mm
Spoke nipples	SAPIM, Polyax	Inside ø: 14G; length: 14 mm
Front wheel hub	SHIMANO, HB-TC500-15-B	32H
Rear wheel hub	FORMULA	Gear hub, continuously variable, 36H
Axle	SHIMANO, AX-MT500-148x12	E-THRU axle
Steering headset	FSA, Orbit E 1.5	
Stem	SATORI, All-Up 2.0 (SR-55)	
Handlebars	BY,SCHULZ, P.2 Super Strong	Ø: 35.0 mm
	BY,SCHULZ, Sport Super Strong	Ø: 35.0 mm
Handles/tapered	ERGON, GC1	Winged grips; size: L
		Winged grips; size: S
Fork	SR SUNTOUR, Mobie35 EQ Boost DS 2CR-PCS 15LH-110 29"	Suspension fork, steel suspension, deflection: 100 mm; spring stiffness: medium; damper: 2CR-PCS; shaft length: 300 mm
Saddle	SELLE ROYAL, Explora Moderate W (50D2DRO)	#
Seat post	LIMOTEC, A3	Ø: 34.9 mm; deflection: 100 mm/length: 2000 mm
Saddle clamp	MR CONTROL, CL-95B	Ø: 38.1 mm
Pedal	VP COMPONENTS, VP-836	#
Crank set	PINION, Crankset Forge 2018 (P8512)	Crank arm, 165 mm

Chain/belt	GATES®, 125T CDX (11M-125T-12CT)	# Belt, polyurethane/carbon; pitch: 11, number of teeth: 125; width: 12 mm; length: # mm
	GATES®, 128T CDX (11M-128T-12CT)	# Belt, polyurethane/carbon; pitch: 11, number of teeth: 128; width: 12 mm; length: # mm
Chain wheel/belt sprocket	GATES®, 39T Pinion # CDX (CDXFP139)	Belt sprocket, 39T, for PINION
	GATES®, 39T Pinion # CDX (CT1139PBA)	Belt sprocket, 39T, for PINION
Chain guard	HORN, Catena A08	Plastic, #
Chain guide/snubber	GATES®, CDECDRL	Snubber
	PINION, P8555	Belt tensioner
	PINION, P8557	Belt tensioner
Sprocket/belt sprocket/freewheel	GATES®, 22T 9-Spline CDX (CT1122SMN)	Belt sprocket, 22T
	GATES®, 24T 9-Spline CDX (CT1124SMN)	Belt sprocket, 24T
	GATES®, 30T 9-Spline CDX (CT1130SMN)	Belt sprocket, 30T
	GATES®, 32T 9-Spline CDX (CDXR329S1)	Belt sprocket, 32T
Shifter	PINION, P5580	Electric shifter
Motor	FIT, Pinion E1.12 (501070)	See Section 3.5.06.1
On-board computer	FIT, Remote Basic (501262)	With spacer
Display	FIT, Comfort (500084)	
Rechargeable battery	FIT, Ultra Tube 815 Wh 48V # (501034)	#
Charger	FIT, 500950	48 V, 3 A
Rear brake	MAGURA, MT4 eSTOP	3-finger brake lever Length: 2500 mm Hydraulic disc brake, 2 pistons
Front brake	MAGURA, MT5 eSTOP	2-finger brake lever Length: 1500 mm Hydraulic disc brake, 4 pistons, for S pedelegs
Brake disc	MAGURA, MDR-C	Ø: 180 mm
Brake disc	MAGURA, Storm HC	Ø 180 mm
Rear light		
Reflectors	BUSCH&MÜLLER, 313/3Z1	Pannier rack fitted with two screws (installation size 50 mm)
Pannier rack, rear		
Stand	PLETSCHER, SW-RA-031J,700C	Kickstand, screw spacing: 40 mm
Bell/horn	KNOG, OI Bell	Bell
Battery lock	ABUS	

... not available

Information not available when document was produced

3.4.2 Chassis

The chassis comprises two components:

- Frame and
- steering system

3.4.2.1 Frame

The frame absorbs all forces which act on pedelec from body weight, pedalling and the ground. The frame also acts as a carrier for most components.

The frame geometry determines the pedelec's ride performance. A frame comprises the following elements:

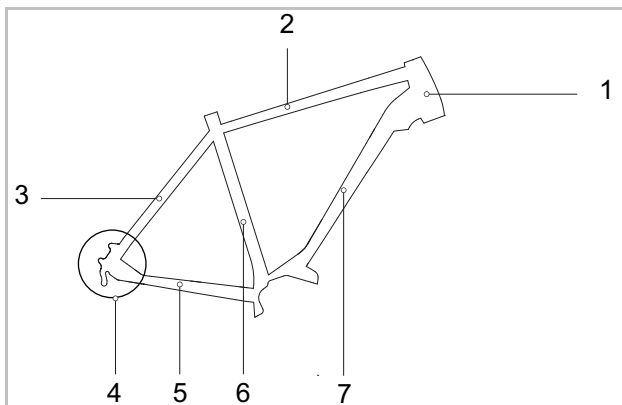

Figure 4: Elements of the frame

- | | |
|---|----------------------|
| 1 | Head tube |
| 2 | Top tube |
| 3 | Rear frame seat stay |
| 4 | Rear frame fork end |
| 5 | Chain stay |
| 6 | Seat tube |
| 7 | Down tube |

Suspension frames also feature a rear frame damper.

Carbon frame

Carbon (CFRP) is a carbon-fibre-reinforced polymer made of high-strength, rigid fibres. Carbon frames comprise several layers of carbon with an epoxy resin matrix. The uppermost layer is known as the visible layer.

Benefits

- Carbon frames are more rigid than aluminium and offer greater fatigue strength.
- Carbon frames do not rust.
- If carbon frames are fitted correctly and are not involved in a serious accident, they have a similar long life cycle to aluminium frames.
- Fatigue is significantly less common in carbon frames than in aluminium frames.

Disadvantages

- Carbon breaks if the maximum load is exceeded.
- Carbon is highly delicate. Interior damage may not be visible on the outside after an accident. Damage can only be detected by pulse thermography or ultrasonic excitation, for example, at a specialist retailer's.
- Carbon frames are sensitive to heat. Several hours over 65 °C can soften the frame and cause the individual layers of carbon to separate from one another. This is called delamination.
- Fractures which cut through carbon fibres cannot be repaired. A new frame needs to be acquired in such a case.
- Carbon is very difficult to recycle.

Frame size

The size of the frame must be adjusted to the rider's height.

City and trekking bicycle, folding bicycle and cargo bike

The tolerance for the frame height and its associated top tube length is somewhat greater for city bicycles due to the more upright riding position. As the handlebars and saddle can be adjusted to the rider's height, the range of recommended frame sizes can be somewhat wider.

Rider's height [cm]	Frame size [cm]	
155... 165	S	43... 48
165... 175	M	48... 53
175... 185	L	53... 58
185... 195	XL	58... 62
195... 215	XXL	62... 65

Table 84: Recommended frame size for city and trekking bicycles

Mountain bike

The frame geometries for mountain bikes differ depending on the type and area of use. The frame size is not dependent on the wheel size. The differences are already taken into account in the recommended frame sizes.

Rider's height [cm]	Frame size [cm]	Wheel size [Inches]
150... 160	33... 37	26
160... 170	38... 43	26, 27.5
170... 180	43... 47	26, 27.5, 29
180... 190	47... 52	26, 27.5, 29
190... 200	51... 56	27.5, 29
200... 215	53... 60	27.5, 29

Table 85: Recommended frame size for mountain bikes

Racing bicycles and gravel bikes

The different frame heights are closer together on racing bicycles and gravel bikes. Smaller increments in the frame heights ensure precise adjustment to the rider's height.

The seat on the pedelec is largely determined by the length of the top tube:

- The shorter the top tube is, the steeper the sitting position is.
- The longer the top tube is, the more stretched-out the sitting position is.

Rider's height [cm]	Frame size [cm]
160... 175	XS
165... 180	S
170... 185	M
175... 190	L
180... 195	XL
185... 200	XXL

Table 86: Recommended frame size for racing bicycles and gravel bikes

Bicycle for young adults

A person grows in height rapidly during adolescence. As a result, the frame size needs to be checked every six months.

Rider's height [cm]	Frame size [cm]
140... 150	33... 35
150... 160	35... 38
160... 170	38... 41
170... 180	41... 46
180... 190	46... 53

Table 87: Recommended frame size for mountain bikes and bicycles for young adults

Child's bike

Children are growing constantly. As a result, the frame size needs to be checked every six months.

It is important that riders, especially learners, can safely put both feet on the ground. Children thus need a pedelec that is appropriate for their height. This is the only way to ensure a safe ride.

Rider's height [cm]	Wheel size [inches]
85... 110	12
90... 120	16
100... 125	18
110... 130	20
120... 145	24
135... 165	26

Table 88: Recommended wheel size for child's bicycles

3.4.2.2 Rear frame damper

A rear frame damper is primarily fitted to mountain bikes and helps to protect the pedelec and rider against impacts and vibrations caused by uneven ground. A rear frame damper deflects when a steel spring, air suspension, or both suspension types act on it.

Negative deflection (sag)

The sag is the percentage of total spring deflection that is compressed by the rider's body weight, including equipment (such as a backpack), their seating position and frame geometry. Sag is not caused by riding.

The rear frame damper rebounds at a controlled speed if it is optimally adjusted. The rear wheel does not bounce off rough surfaces or the ground; it stays in contact with the ground instead (blue line).

The saddle is raised slightly if the bump is compensated and gently sinks downwards when the suspension deflects as soon as the wheel touches the ground after the bump. The rear frame damper rebounds in a controlled way, so that the rider remains sitting in a horizontal position when the next bump is absorbed. The suspension motion is predictable and controlled. The rider is not thrown upwards or forwards (green line).



Figure 5: Optimum rear frame damper riding performance

When optimally adjusted, the rear frame damper counteracts deflection, stays higher in its

deflection range and helps to maintain speed when riding on hilly parts of terrain.

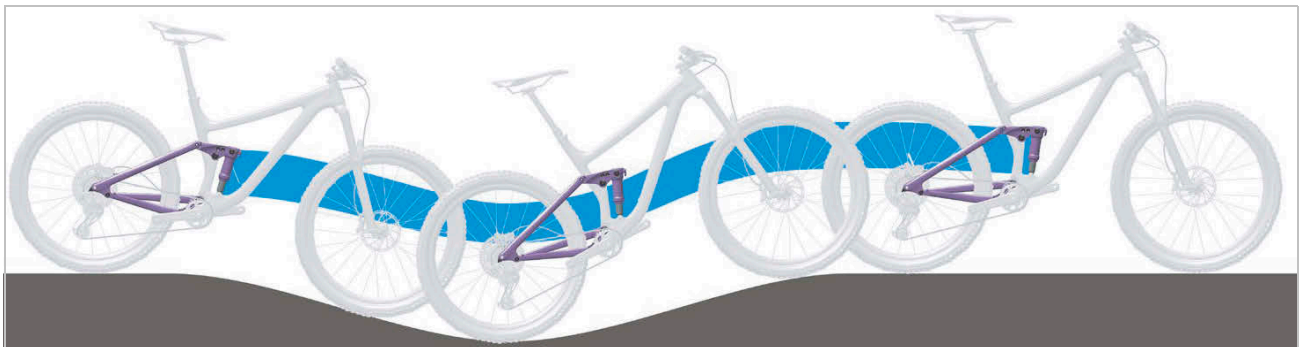

Figure 6: Optimum rear frame damper ride performance on hilly terrain

When optimally adjusted, the rear frame damper deflects quickly and unhindered when the bike hits bumps and absorbs a bump. Traction is retained (blue line).

The saddle rises slightly when absorbing a bump (green line).



Figure 7: Optimum rear frame damper ride performance over bumps

ROCKSHOX Deluxe Select+ structure design**Figure 8: ROCKSHOX Deluxe Select rear frame damper structure design**

- 1 Air valve (rear frame damper)
- 2 Rebound adjuster (rear frame damper)
- 3 Compression lever (rear frame damper)
- 4 O-ring
- 5 Scale

3.4.2.3 Steering system

The steering system components are:

- Steering headset,
- Stem,
- Handlebars and
- Suspension fork.

3.4.2.4 Steering headset

The steering headset (also known as a bike headset or simply a headset) is the fork bearing system in the frame. A distinction is made between two different types:

- Conventional steering headsets for fork steerers with thread and
- Steering headsets for threadless fork steerers or what are known as headsets.

3.4.2.5 Stem

The stem connects the handlebars to the fork steerer tube. The stem is used to adjust the handlebars to body size. The stem is used to adjust the handlebar height and the gap between the handlebars and saddle (see Section 6.4.6).

Quickly adjustable stems

Quickly adjustable stems are an extension to the fork steerer. You can change the height and angle of quickly adjustable stems without any tools. Up to 3 settings can be adjusted, depending on the model:

- 1 Adjust handlebar height
- 2 Adjust twist function
- 3 Adjust stem angle.

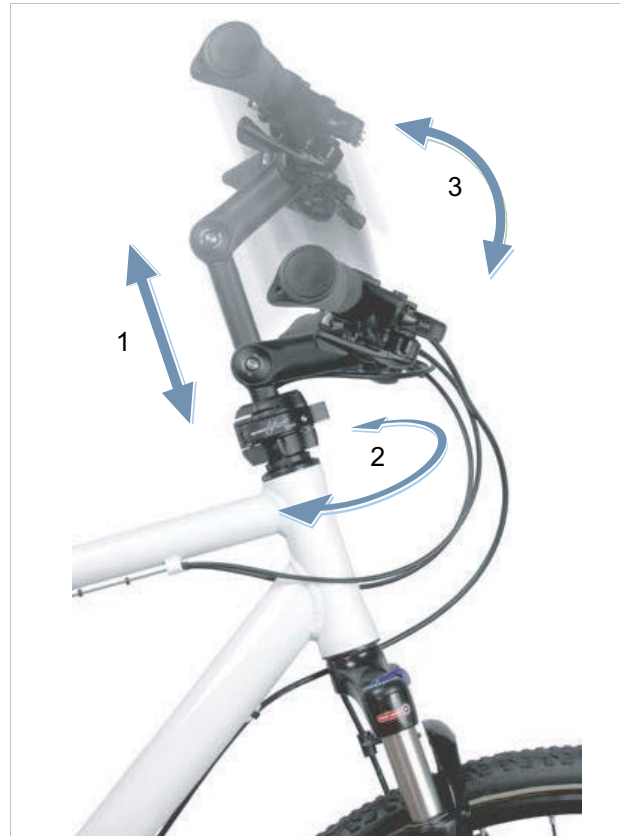

Figure 9: Example – BY.SCHULZ seat Speedlifter Twist Pro SDS

Adjusting the height and stem angle increase riding comfort as different riding positions can be adopted on longer rides. The twist function saves space when parking.



Figure 10: Twist function, using BY.SCHULZ as an example

3.4.2.6 Handlebars

The pedelec is steered using the handlebars. The handlebars are used to support the upper body and are used to mount operating and display components (see Section 3.4.1).

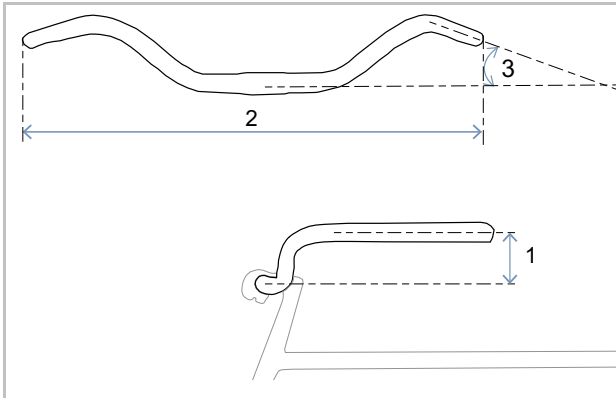

Figure 11: Handlebar dimensions

The main dimensions of handlebars are:

- 1 Rise
- 2 Width
- 3 Backsweep

3.4.2.7 Suspension fork

The stem and handlebars are attached to the top end of the fork steerer. The axle is fastened to the fork ends. The wheel is fastened to the axle.

Unlike rigid forks, suspension forks improve contact with the ground and thus enhance comfort using two functions:

- Suspension and
- Damping (optional function).

Suspension

A suspension fork deflects when a steel suspension, air suspension or both suspension types act on it.

A pedelec's suspension prevents an impact, such as one caused by a stone lying in the pedelec's path, from being channelled directly into the rider's body via the suspension fork. The impact is absorbed by the suspension system instead. This causes the suspension fork to compress.

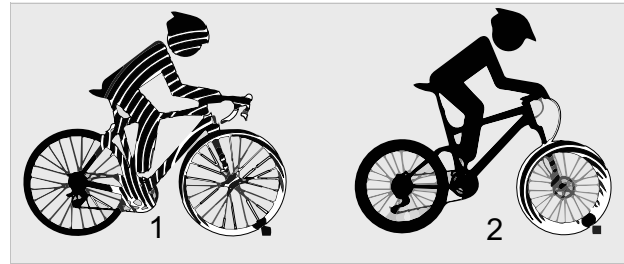

Figure 12: Without suspension (1) and with suspension (2)

Damping

After compressing, the suspension fork returns to its original position. If there is a damper, it will decelerate movement, preventing the suspension system from springing back in an uncontrolled manner and stopping the suspension fork vibrating up and down. A distinction is made between two types of dampers:

- Rebound dampers,
- Compression dampers.

Rebound dampers and compression dampers can be optionally divided into two different sections:

- High-speed damper,
- Low-speed damper.

Parts of a suspension fork

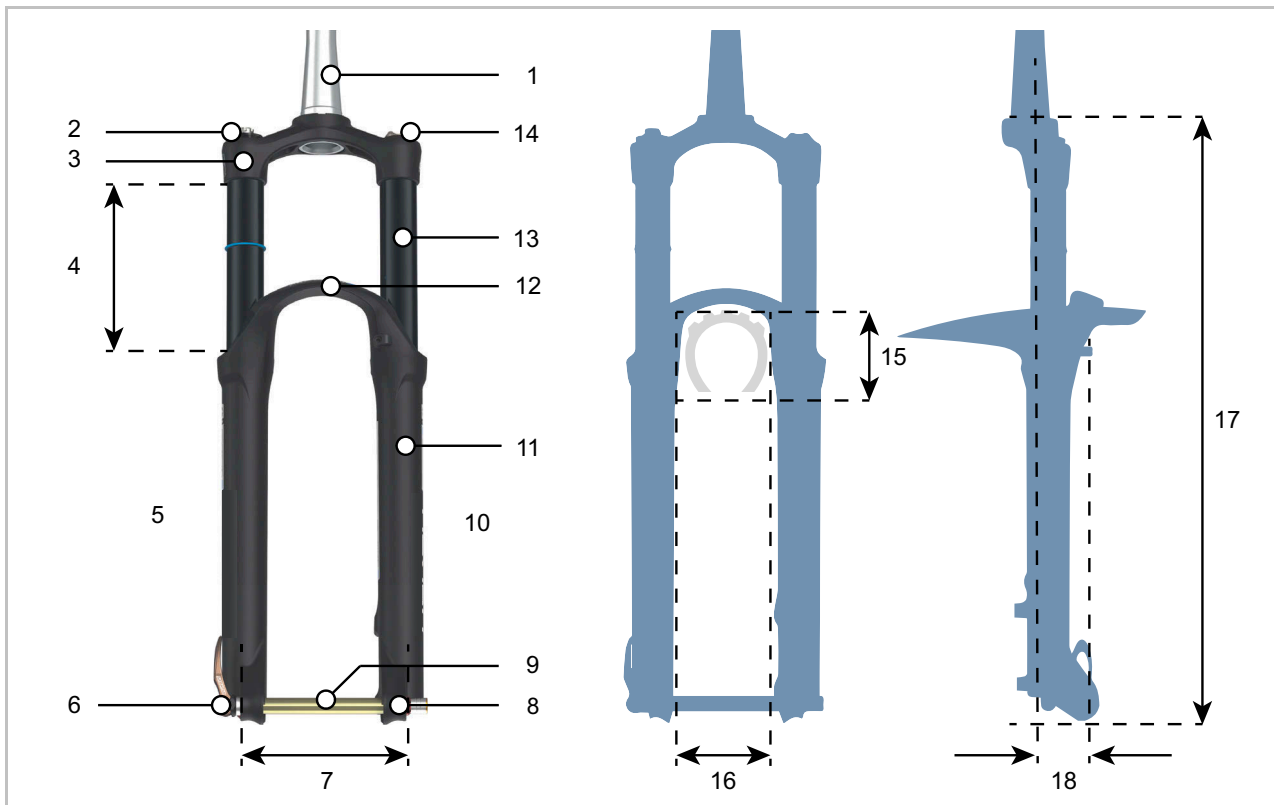

Figure 13: Parts of a suspension fork

- 1 Fork steerer
- 2 Sag adjuster
- 3 Fork crown
- 4 Deflection (suspension fork)
- 5 Damper side
- 6 Quick release
- 7 Pitch
- 8 Fork end (suspension fork)
- 9 Quick release axle
- 10 Air suspension side
- 11 Stanchion
- 12 Fork bridge
- 13 Stanchion
- 14 Lock

Tyre clearance

- 15 Tyre height
- 16 Tyre passage width

Side view

- 17 Installation height
- 18 Offset

Suspension fork assembly groups

A suspension fork can feature up to three different assembly groups:

- Compression damper (blue)
- Rebound damper (red)
- Air suspension or steel spring (orange)

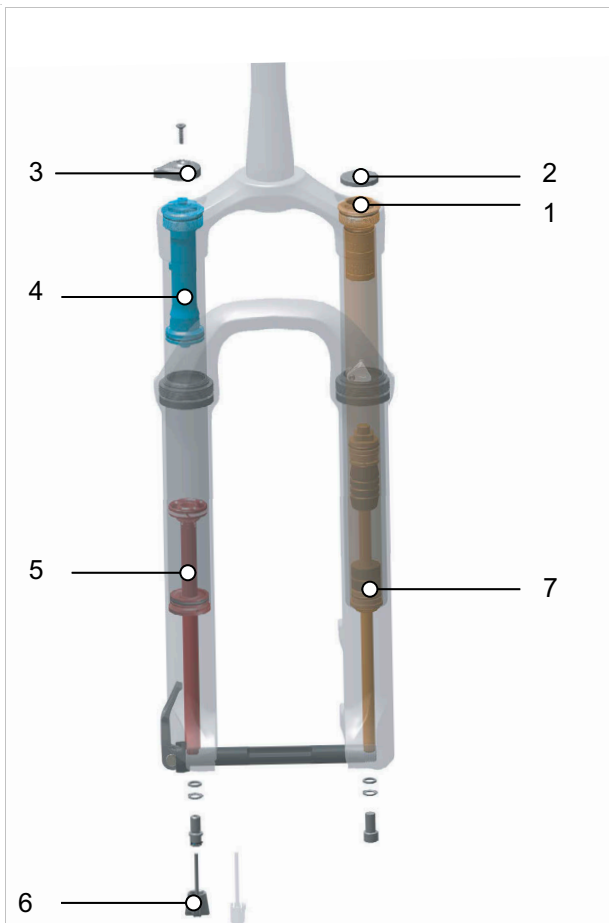

Figure 14: Internal structure of an air suspension fork

- 1 Air valve (fork)
- 2 Air valve cap
- 3 Damping adjuster
- 4 Compression dampers
- 5 Rebound damper
- 6 Rebound adjuster (suspension fork)
- 7 Air suspension

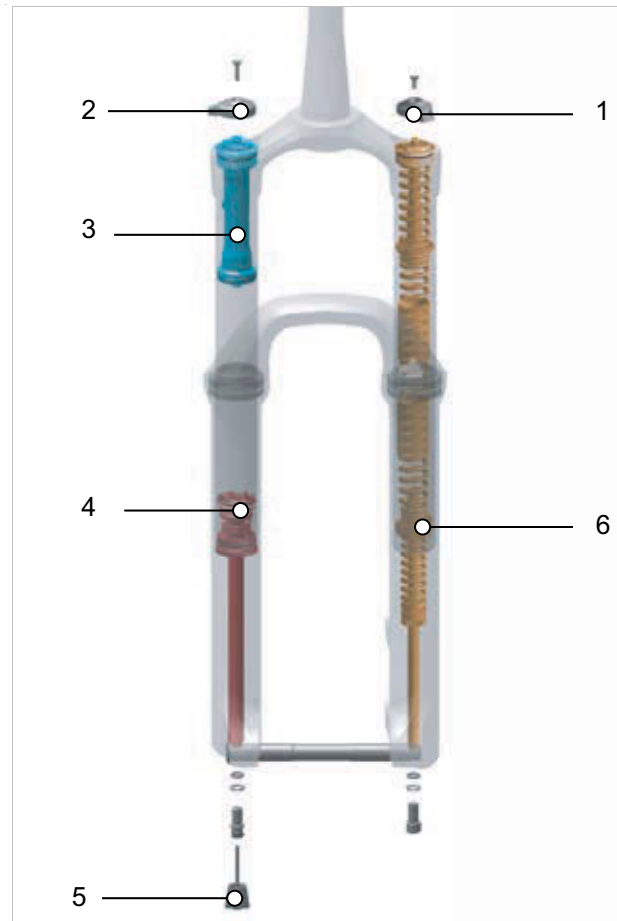

Figure 15: Internal structure of a steel suspension fork

- 1 Sag setting wheel
- 2 Damping adjuster
- 3 Compression dampers
- 4 Rebound damper
- 5 Rebound adjuster (suspension fork)
- 6 Steel spring

Cartridges

Dampers may be housed in closed structural elements, known as cartridges. These cartridges are fitted into the suspension fork. Different cartridges can be fitted into forks. This has no effect on the suspension fork's total bearing capacity.

Lock

The compression can be disabled in any suspension fork. A suspension fork will then behave like a rigid fork.

A suspension system is designed to cushion and compensate for unevenness on a surface whether the user is riding on bumpy cycle paths, dirt roads or off road.

A suspension system absorbs great deal of motor and muscle power during rides uphill or on optimally tarmacked roads. This increases energy consumption and reduces propulsion. It thus makes sense to lock the suspension on tarmacked roads and when riding uphill.

Some suspension forks thus feature a lockout on the fork crown or a remote lockout on the handlebars.

Negative deflection (sag)

The negative deflection (sag) is the percentage of entire deflection that is compressed by the rider's body weight, including equipment (such as a backpack), the seating position and frame geometry. Sag occurs whether you are actually riding or not.

The pedelec rebounds at a controlled speed if it is optimally adjusted. The wheel stays in contact with the ground when passing over bumps (blue line). The fork head, handlebars and body follow terrain (green line) when riding over bumps. The suspension motion is predictable and controlled.



Figure 16: Optimum suspension fork ride performance

When optimally adjusted, the suspension fork counteracts deflection on hilly terrain and remains higher in its deflection range.

This allows the rider to maintain the same speed more easily on hilly terrain.



Figure 17: Optimum suspension fork ride performance on hilly terrain

The suspension fork also deflects quickly and unhindered when hitting bumps and cushions the bump when placed at an optimum setting. Traction is retained (blue line).

The suspension fork responds instantly to the impact. The headset and handlebars rise slightly when absorbing a bump (green line).



Figure 18: Optimum suspension fork ride performance over bumps

Rebound dampers

Rebound dampers damp rebound movements, i.e. rebound stress loads.

Rebound damping determines the speed at which the suspension rebounds after being exposed to load. Rebound damping controls the suspension fork extension and rebound speed, which, in turn, has an impact on traction and control.

The damper rebounds at a controlled speed if the suspension fork is optimally adjusted. The wheel stays in contact with the ground when passing over bumps (blue line). The fork head, handlebars and body follow terrain (green line) when riding over bumps. The suspension motion is predictable and controlled.



Figure 19: Optimum suspension fork ride performance

Compression dampers

Compression dampers damp deflection movements, i.e. compression loads.

The compression damper controls the compression stroke speed or the extent to which the suspension fork deflects during slow impacts.

When optimally adjusted, the suspension fork counteracts deflection on hilly terrain, stays higher in its deflection range and helps to maintain speed when riding on hilly terrain.

The suspension fork deflects instantly unhindered and absorbs bumps when the bike hits one. Traction is retained (blue line).



Figure 20: Optimum ride performance on hilly terrain

High-speed damper

The high-speed damper (also abbreviated to HSC from *high-speed compression*) is a specialised compression damper.

A high speed is generated in the suspension fork

on a mogul slope or on landing after a jump.

The high-speed damper controls the suspension fork's behaviour positively in such riding situations.

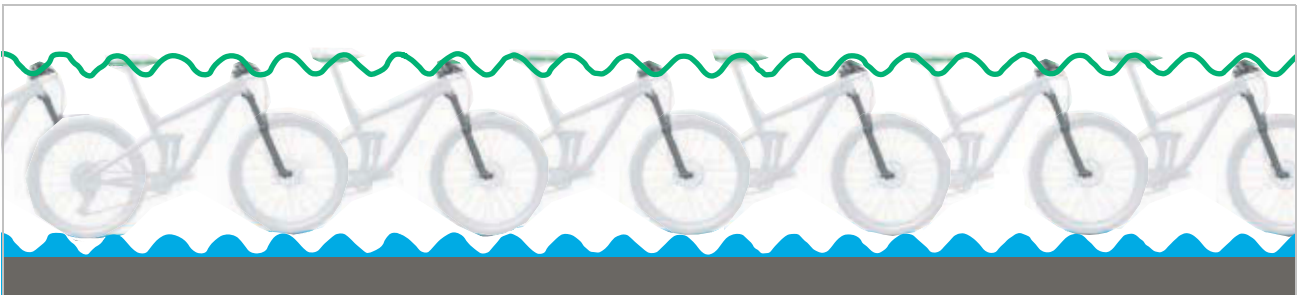

Figure 21: High-speed movements

Low-speed damper

The low-speed damper (also abbreviated to LSC from *low-speed compression*) is a specialised compression damper.

A slow compression speed is generated in the suspension fork when riding over bumps. The low-speed damper controls the suspension fork's behaviour positively in such riding situations.



Figure 22: Low-speed movements

3.4.2.8 SR SUNTOUR 2CR-PCS



Figure 23: Operating elements for the 2CR-PCS

The Suntour 3CR-PCS cartridge features a PCS damper platform with

- a low-speed compression damper
- a rebound damper

Floating pistons within the PCS cartridge provide consistent damping on all driving surfaces through minimal cavitation (formation and dissolution of bubbles by mixing air and oil).

Before riding, the rebound adjuster (1) is used to adjust the system to the surface concerned.

While riding, the user can select two settings on the compression adjuster (2) to adapt the suspension system to the current ground surface:

- FIRM
- OPEN

If the pressure in the fork is too high, the blow-off feature releases air by opening a valve. This prevents any damage due to overpressure.

		Function available
	Lockout remote control	...
	Fork head lockout	...
Compression damping	High-speed	x
	Low-speed	x
	Fixed	...
Rebound damping	High-speed	...
	Low-speed	x
	Fixed	...
	Blow-off feature	x
	PCS	x

Table 89: An overview of SR SUNTOUR 2CR-PCS functions

3.4.3 Wheel

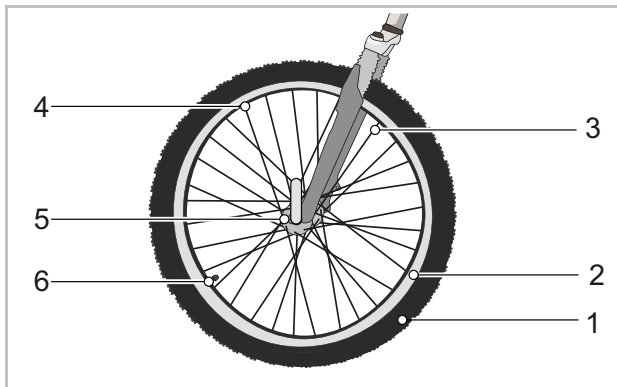

Figure 24: Visible wheel components

1	Tyres
2	Rim
3	Spoke
4	Spoke nipples
5	Hub
6	Valve

The wheel comprises a tyre, an inner tube with a valve and the wheel itself.

3.4.3.1 Tyres

The tyre forms the outer section of the wheel. The tyre is pulled onto the rim. Tyres differ in design, profile and width, depending on their intended use.



Figure 25: Example: Information on tyres

Tyre size

The tyre size pressure range is indicated on the side of the tyre.

Tyre pressure

The permitted pressure range is indicated on the side of the tyre. It is indicated in psi or bars. The tyre is only able to support the pedelec if there is adequate tyre pressure. The tyre pressure must be adjusted to the body weight and then checked on a regular basis.

Tyre design types

There are five different tyre design types:

- Tube-type tyres
- Tubeless tyres (also tubeless ready)
- Tubular or single tube tyres
- Solid tyres
- Mixed types.

3.4.3.2 Tube-type tyre

A distinction is made between different kinds of tube-type tyre:

- Clinchers with steel wire reinforcement in bead core
- Folding tyres with aramid fibre reinforcement in bead core
- Beaded edge tyres without reinforcement in the bead core but with pronounced beads that hook under the rim edge and overlap in the rim well



Figure 26: Structure of tube-type tyre

1	Rim
2	Tread with profile
3	Puncture protection belt (optional)
4	Carcass
5	Bead core

Carcass

The carcass is the tyre's supporting structure. There are usually three carcass plies beneath the tread. The carcass comprises a webbing with threads, usually made of polyamide (nylon). The webbing is coated with rubber on both sides and cut at an angle of 45°. The carcass gives the tyre stability thanks to this cut at an angle to the direction of travel. The carcass plies are woven with different densities, depending on the quality of the tyres. The density of the carcass fabric is indicated by the number of threads per inch, in EPI (*ends per inch*) or TPI (*threads per inch*). There are tyres with between 20 and 127 EPI carcasses.

If the EPI value is higher, the diameter of the threads used is lower. Carcass plies with a higher EPI value have threads with a smaller diameter. The higher the EPI value:

- the less rubber is needed to encase the threads,
- the lighter the tyres are
- the more flexible the tyres are and they consequently have less rolling resistance.
- The webbing is denser so that it is more difficult for foreign bodies to penetrate. This increases puncture resistance.

In carcasses with 127 EPI, each individual thread is just 0.2 mm thick and, consequently, more susceptible to damage. This means that a 127 EPI tyre offers low puncture protection. 67 EPI offers the optimum compromise between weight and robustness.

Besides the webbing, the tyre's rubber compound is also important. The rubber compound comprises numerous parts:

40 ... 60%	Natural and synthetic rubber
15 ... 30%	Fillers, e.g. carbon black, silicic acid or silica gel
20 ... 35%	<ul style="list-style-type: none"> • Anti-ageing agent • Vulcanisation agent, e.g. sulphur • Vulcanisation accelerator, e.g. zinc oxide • Pigments and dyes

Table 90: Rubber compound in carcasses

Tread with profile

A rubber tread is attached to the exterior of the carcass.

The tread has little influence on riding characteristics on a smooth road. The grip between the road and tyre is mainly provided by the rolling friction between the rubber and the road surface.

Slicks and road tyres

Unlike cars, a pedelec will not aquaplane. The tread contact is small and the contact pressure high. Thanks to the small contact surface on narrow and treadless tyres, the tyre interlocks with the road surface finish. Theoretically, the tyre will not aquaplane until speeds of 200 km/h are reached.

On a clean road, whether dry or wet, slick tyres will grip more effectively than treaded tyres because the contact surface is larger. The rolling resistance of slick tyres is also lower.

Off-road tyres

The tread is highly important on terrain. In this case, the tread creates an interlock with the ground, thus enabling the driving, braking and steering forces to be transmitted. The MTB tread can also help improve control on dirty roads or farm tracks.

Tread blocks on MTB tyres deform as they meet the contact surface. The energy used for this is partly converted into heat. Another part is stored and converted into the tread block's sliding movement when it leaves the contact surface, which contributes to the tyre's wear.

If a tyre with a deep tread is used on asphalt, this may make an unpleasant noise. If a pedelec with an MTB tyre is mainly ridden on the road, it is thus best to change the tyre for a pair of tyres with as little tread as possible to reduce wear and save energy. In such a case, the specialist dealer needs to replace the tyre with a new one with a shallow tread.

Bead core

Tyre carcasses are wrapped around bead cores. Wrapping the carcass around both sides creates three carcass plies.

To ensure that tyres do not slip when inflated on the rim and have an effective grip, the bead cores are stabilised in two different ways:

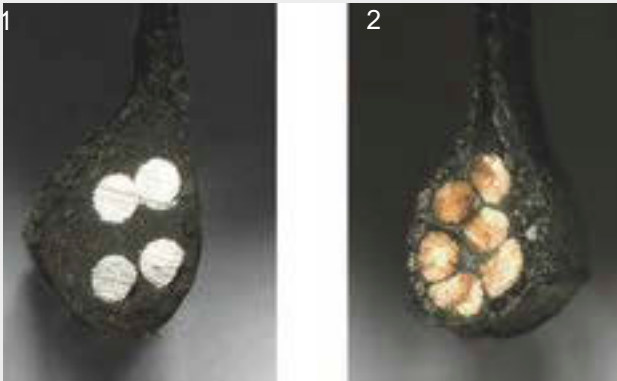

Figure 27: Steel bead core (1) and Kevlar bead core (2)

- with a steel wire. These tyres are called clinchers.
- with aramid fibres (Kevlar®). These tyres are called folding tyres. Folding tyres are about 50-90 g lighter than clinchers. It can also be folded into a smaller pack size.

Puncture protection belt (optional)

There may be a puncture protection belt between the carcass and the tread.



Figure 28: Effect of puncture protection belt

Each tyre manufacturer has its own puncture protection classes which are not on par with one another.

3.4.3.3 Rim

The rim is the metal profile on a wheel which holds the tyre, tube and rim band together. The rim is joined to the hub with spokes.

In rim brakes, the outer surface of the rim is used to brake.

3.4.3.4 Valve

Each tube-type tyre has a valve. Air is pumped into the tyre via the valve. There is a valve cap on each valve.

The screw-on valve cap keeps out dust and dirt.

The pedelec has either a:

- Dunlop valve
- Presta valve
- Schrader valve

Dunlop valve

The Dunlop valve, also known as a conventional valve, is the most widely used valve. The valve insert can be replaced easily and air can be let out very quickly.

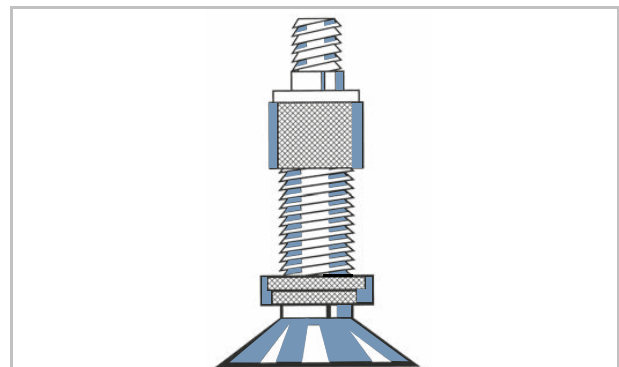

Figure 29: Dunlop valve

Presta valve

The Presta valve, also known as the Sclaverand valve or the French valve, is the narrowest variant of all valves. The Presta valve requires a smaller hole in the rim, which is why it is especially suitable for the narrow rims on racing bikes. It is about 4 to 5 g lighter than a Dunlop or Schrader valve.

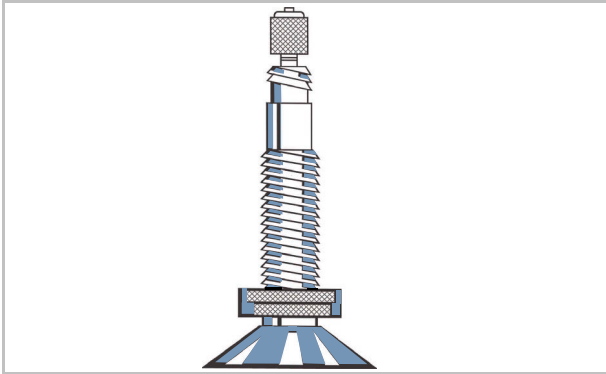

Figure 30: Presta valve

Schrader valve

The Schrader valve can be pumped at filling stations. Older, simple bicycle air pumps are unsuitable for Schrader valves.

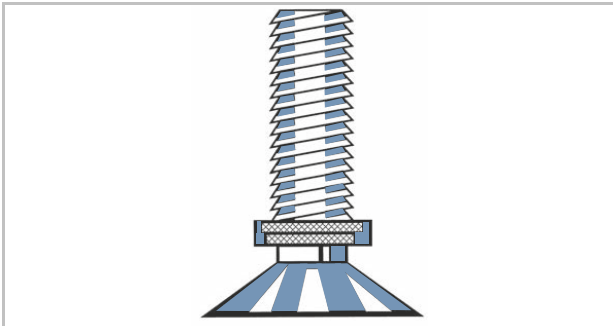

Figure 31: Schrader valve

3.4.3.5 Spoke

A spoke is a rod that connects the hub to the rim. The bent end of the spoke which is hooked into the hub is called the spoke head. A thread between 10 mm and 15 mm is attached to the other end of the spoke.

3.4.3.6 Spoke nipples

Spoke nipples are screw elements with an internal thread which fits onto the spoke thread. Fitted spokes are tensioned by tightening the spoke nipples. This straightens the wheel uniformly.

3.4.3.7 Hub

The hub is located in the centre of the wheel. The hub is connected to the rim and tyre with the spokes. An axle runs through the hub, connecting the hub with the fork at the front and with the frame at the rear.

The hub's main task is to transfer the pedelec's force of weight to the tyres. Special hubs on the rear wheel perform additional functions. There is a distinction between five types of hub:

- Hubs without additional features
- Brake hub (see back-pedal brake)
- Gear hub, also known as a hub gear
- Generator hub (for bicycles only)
- Motor hubs (for front- and rear-driven pedelecs only).

Hub without additional features

The front wheel hubs on pedelecs with central or rear motors are normally hubs without additional features.

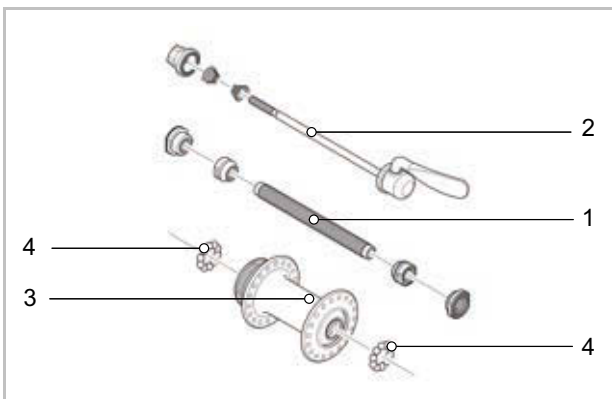

Figure 32: Example of front wheel hub: SHIMANO

- | | |
|---|---------------|
| 1 | Hub axle |
| 2 | Quick release |
| 3 | Hub body |
| 4 | Ball bearings |

3.4.4 Brake

A pedelec's brake system is primarily operated using the brake lever on the handlebars.

- If the left brake lever is pulled, the brake on the front wheel is applied.
- If the right brake lever is pulled, the brake on the rear wheel is applied.

The brakes are used to regulate speed and make an emergency stop. Applying the brakes will bring the pedelec to a safe, rapid halt in an emergency.

The brake is applied using the brake lever either

- with the brake lever and brake cable (mechanical brake) or
- with the brake lever and hydraulic brake cable (hydraulic brake).

3.4.4.1 Mechanical brake

The brake lever is connected to the brake via a wire inside the shift cable (also known as a Bowden cable).



Figure 33: Bowden cable structure

3.4.4.2 Hydraulic brake

The brake fluid is in a closed hose system. If the brake lever is pulled, the brake fluid transfers pressure to the brake on the wheel.

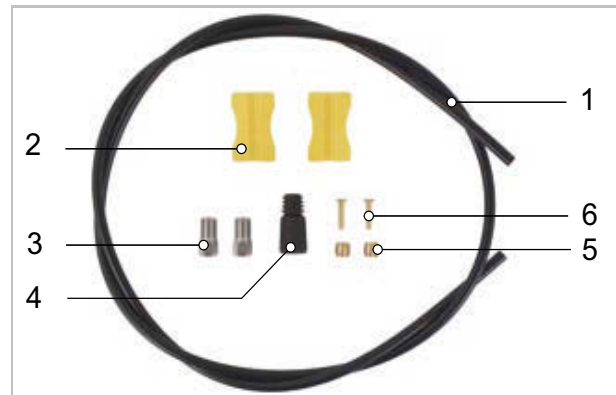

Figure 34: Components in a brake cable

- | | |
|---|-------------|
| 1 | Brake cable |
| 2 | Cable clip |
| 3 | Union nut |
| 4 | Cover cap |
| 5 | Knob |
| 6 | Insert pin |

3.4.4.3 Disc brake

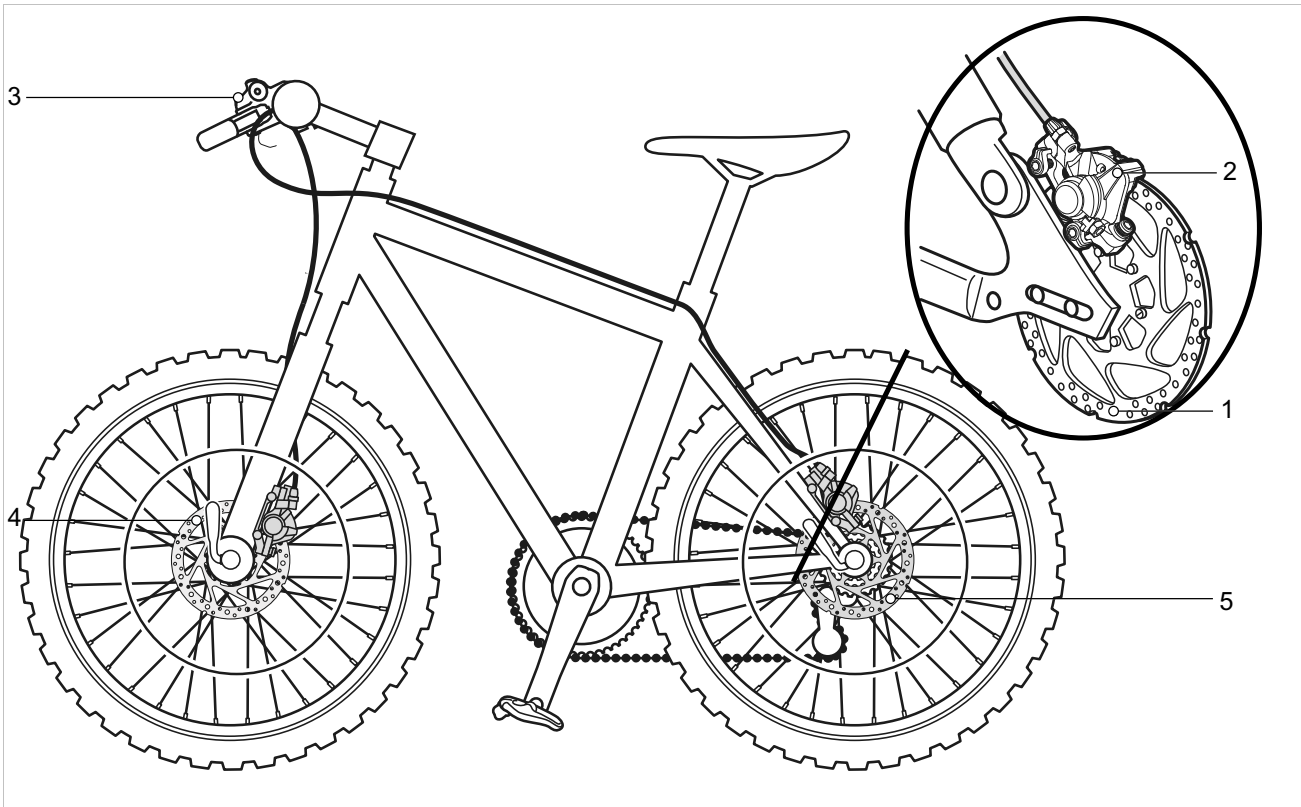

Figure 35: Brake system with disc brake – example

- 1 Brake disc
- 2 Brake calliper with brake linings
- 3 Handlebars with brake lever
- 4 Front wheel Brake disc
- 5 Rear wheel brake disc

On a pedelec with a disc brake, the brake disc is permanently screwed to the hub.

You increase brake pressure by pulling the brake lever. The brake fluid is used to transfer pressure through the brake cables to the cylinders in the brake calliper.

The braking force is boosted by a speed reduction and applied to the brake linings. These apply the brake disc mechanically. If the brake lever is pushed, the brake linings are pressed against the brake disc and the wheel movement is decelerated until it comes to a stop.

3.4.5 Saddle

The purpose of the saddle is to absorb body weight, provide support and enable different riding positions. The shape of the saddle thus depends on the intended use of the pedelec and the rider's physique and posture.

When riding, the rider's body weight is distributed between the pedals, the saddle and the handlebars. When the rider is in an upright position, the relatively small saddle area bears about 75% of their body weight.

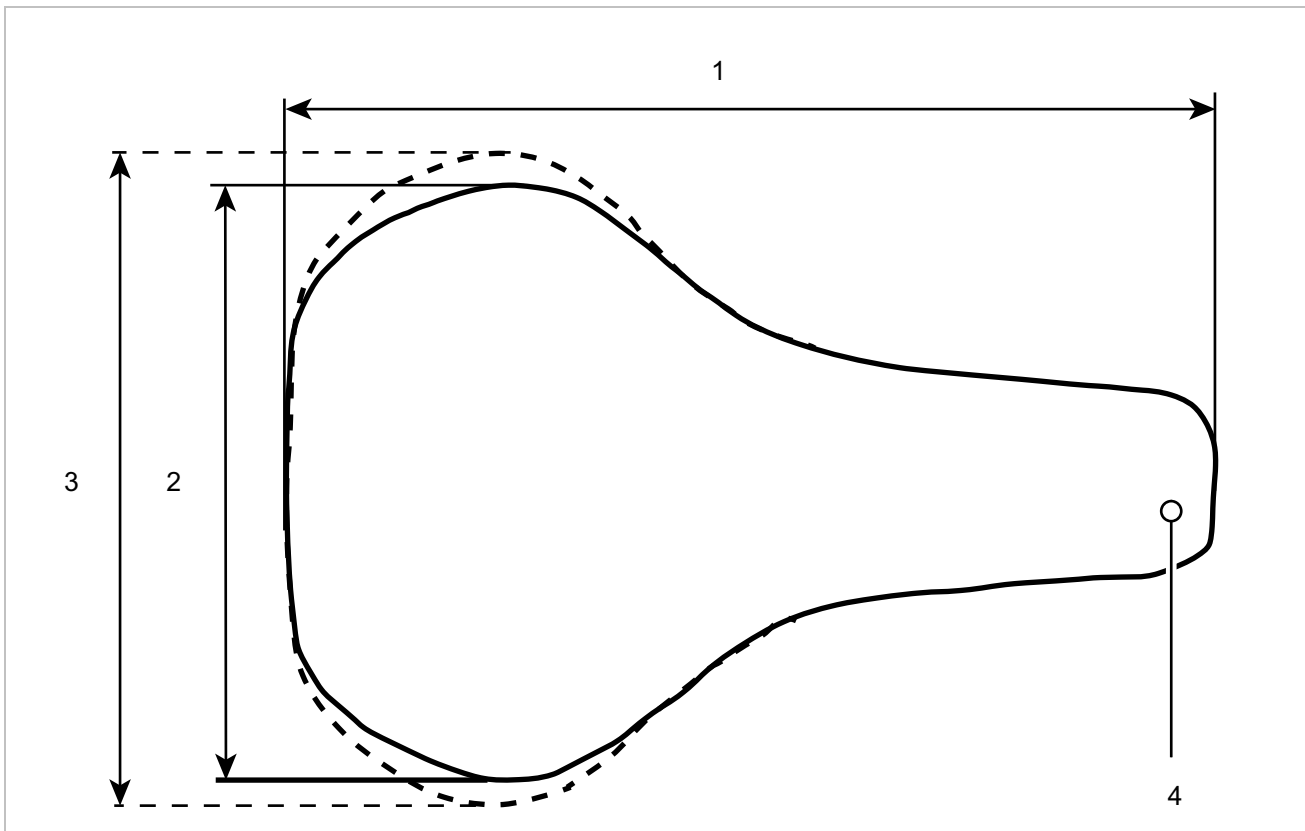

Figure 36: Saddle dimensions

- 1 Saddle length
- 2 Saddle width (narrow version)
- 3 Saddle width (wide version)
- 4 Saddle nose

The seat area is one of the most sensitive regions of the body. The saddle should allow the rider sit free of pain and fatigue. The saddle shape must suit each individual's anatomy. Solutions for sitting discomfort are listed in Section 9.1.

Saddles are provided in different sizes. The width of the pelvis and the gap between the sitting bones is crucial when selecting a saddle. Different saddle variants thus differ in their width.

You will find two methods to calculate the minimum saddle width in Sections 6.4.4.3 and .

3.4.5.1 Ladies' saddle

The distance between the ischial tuberosities and the pubic symphysis is on average a quarter less in women than in men. This is why painful pressure points can occur on men's saddles through the saddle nose since saddles that are too narrow or too soft press on the genitals or coccyx.

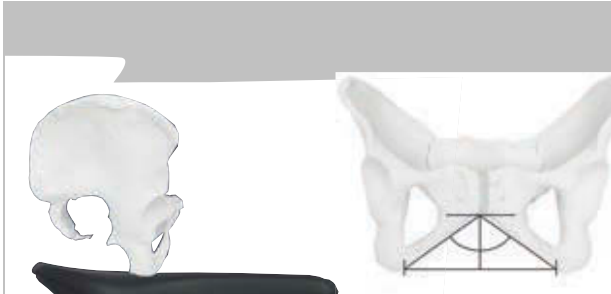

Figure 37: Female pelvis on saddles

For anatomical reasons, the pubic symphysis (front cartilage connection between the two halves of the pelvis) is, on average, a quarter lower than in the male pelvis. The angle between the pubic bones is wider.

The pelvis is more mobile in women than it is in men. Consequently, the pelvis often tilts forward more on the saddle. This causes high pressure in the genital area.

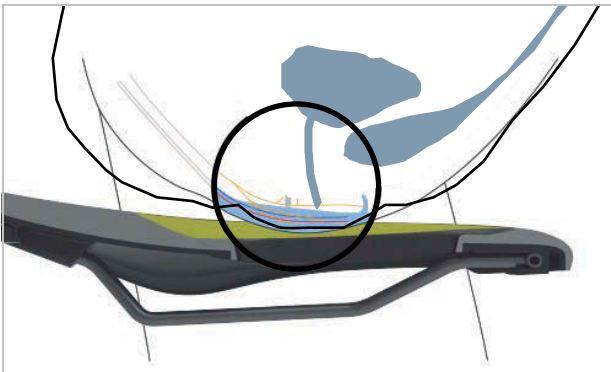

Figure 38: Pressure points on a saddle, female anatomy

3.4.5.2 Men's saddle

In contrast to the female anatomy, men's pubic bones are at a much steeper angle to one another. The pubic symphysis is much higher.



Figure 39: Male pelvis on saddles

The male pelvis is less flexible than women's. Men sit more upright on the saddle and put greater strain on the sitting bones. This means that the transition area between the saddle rear and nose can be kept narrow (Y-shape). This gives more space to pedal.

Numbness when pedalling is often caused by high pressure in the sensitive perineal area. If the saddle is adjusted incorrectly, too narrow or too hard, the nose of the saddle presses directly onto the genitals. Blood circulation deteriorates. The genitals on the outside are seldom the cause of discomfort since they can move out of the way and are not compressed by bone structures.

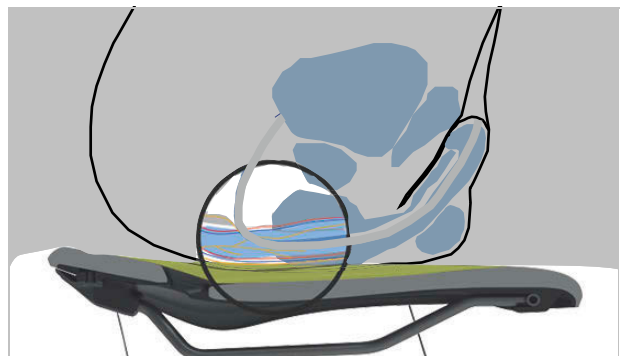

Figure 40: Pressure points on a saddle, male anatomy

3.4.6 Seat post

Seat posts are not designed to fasten the saddle but also to adjust exactly to the optimum sitting position. The seat post can:

- adjust the seat height in the seat tube
- adjust the saddle horizontally with a clamping mechanism and
- adjust the saddle angle by swivelling the entire saddle clamping mechanism.

Retractable seat posts feature a remote control on the handlebars, which can be used to lower the seat post at traffic lights, for example, and then raise it again.

3.4.6.1 Patent seat post



Figure 41: Example of ergotec patent seat post with either one or two seat clamp screws

Patent seat posts have a rigid link between the saddle and the post. Patent seat posts which are angled more markedly towards the rear are offset seat posts. Offset seat posts provide a greater distance between the saddle and the handlebars.

In patent saddle posts, the saddle is attached to the head with one or two seat clamp screws. It is recommended to lubricate the thread in these screws to ensure sufficient tension when tightening the screw.

Patent saddle posts are fastened into the seat tube with either a quick release or a screwable clamp.

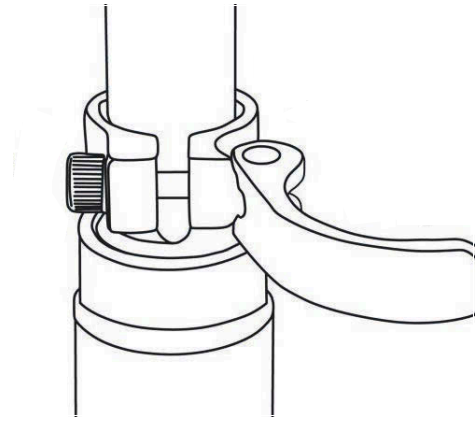

Figure 42: Example of a quick release

3.4.6.2 Suspension seat post

Suspension seat posts can reduce shock after one-time hard impacts, thus improving ride comfort significantly. However, suspension seat posts are not able to compensate for bumps in the road.

If the seat post is the only suspension element, the entire pedelec is a non-suspended mass. This has an unfavourable effect on loaded touring bikes or pedelecs with child trailers.

Suspension seat posts feature small, heavy-duty slide bearings, guides and articulated joints. If they are not lubricated on a regular basis, the sensitive response behaviour diminishes considerably, causing excessive wear.

The pre-tensioning in non-damped suspension seat posts must be adjusted in such a way that the suspension seat post does not deflect with just body weight. This prevents the suspension seat post from deflecting and bobbing intermittently at higher pedalling frequencies or if the rider pedals irregularly.

The spring stiffness can be set lower with damped suspension seat posts, thus making use of the negative deflection.

3.4.6.3 Structure of LIMOTEC A3 dropper post

The LIMOTEC Alpha 3 suspension seat post is a continuously height-adjustable seat post, which can be lowered using a remote control on the handlebars.

The remote control can be used to adjust the saddle height during a ride, e.g. when stopped at traffic lights. Both hands remain on the handlebars during adjustment.

The suspension in the seat post ensures sitting comfort when riding over rough terrain (e.g. in woodland or on farm tracks).

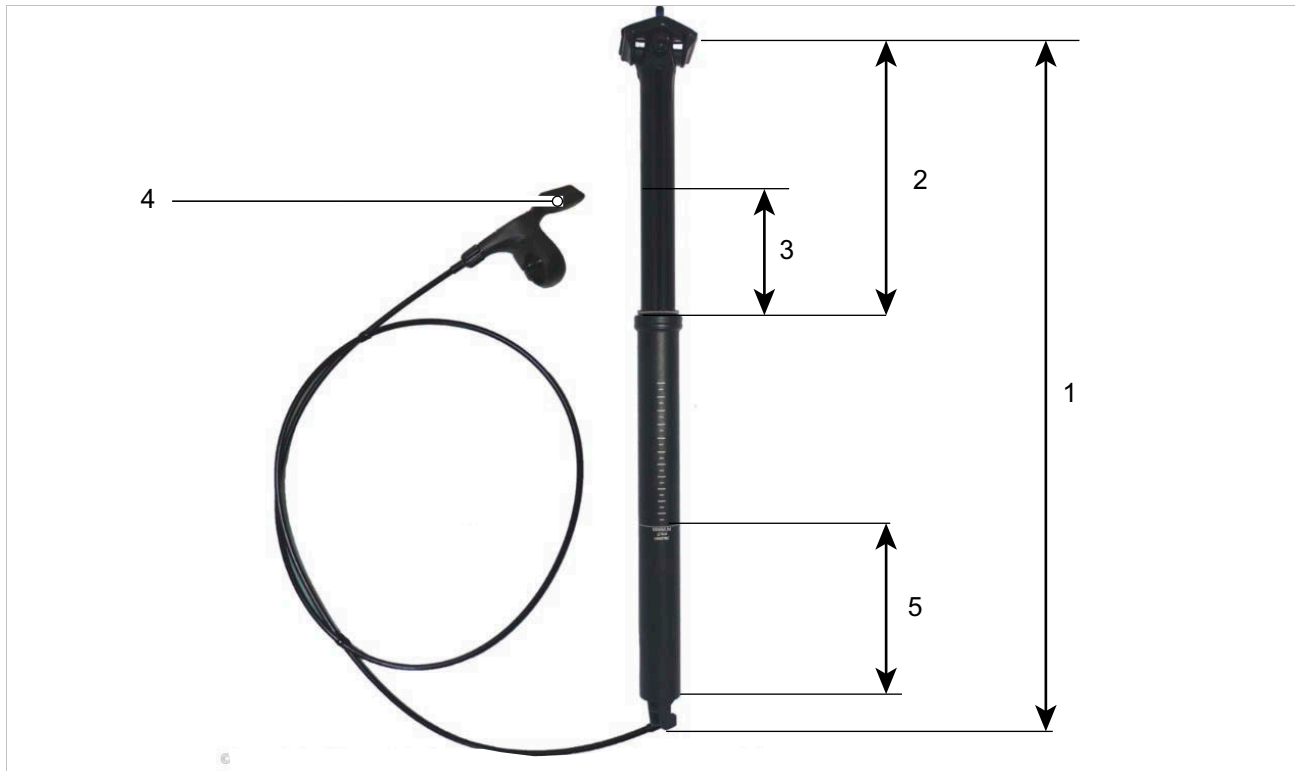

Figure 43: Structure and dimensions of the LIMOTEC A3 seat post

- 1 Seat post length
- 2 Stroke travel
- 3 Deflection
- 4 Seat post remote control
- 5 Minimum insertion depth

Stroke travel

The stroke travel is the maximum height that the seat post can extend.

Deflection

Deflection is the distance that the suspension seat post can deflect.

3.4.7 Mechanical drive system

The pedelec is driven by muscle power, just like a bicycle.

The force which is applied by pedalling in the direction of travel drives the front chain wheel. The chain or belt transmits the force onto the rear chain wheel and then onto the rear wheel.

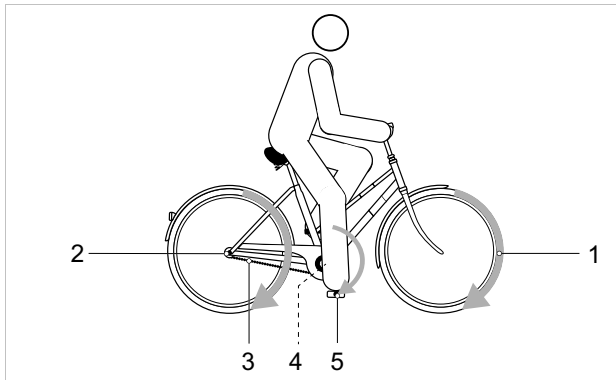

Figure 44: Diagram of mechanical drive system

- | | |
|---|----------------------------------|
| 1 | Direction of travel |
| 2 | Chain or belt |
| 3 | Rear chainring or belt sprocket |
| 4 | Front chainring or belt sprocket |
| 5 | Pedal |

The pedelec is equipped with either a chain or belt drive.

3.4.7.1 Chain drive layout



Figure 45: Chain drive with derailleur gears

- | | |
|---|-----------------|
| 1 | Rear derailleur |
| 2 | Chain |

The chain drive is compatible with a

- Back-pedal brake,
- Hub gear or
- Derailleur gears.

3.4.7.2 Parts of a belt drive



Figure 46: Belt drive

- | | |
|---|---------------------|
| 1 | Front belt sprocket |
| 2 | Rear belt sprocket |
| 3 | Belt |

A belt drive is compatible with

- Back-pedal brake and
- Hub gear.

A belt drive is not compatible with derailleur gears.

3.4.8 PINION electric drive system

The pedelec has an electric drive system in addition to a mechanical one.

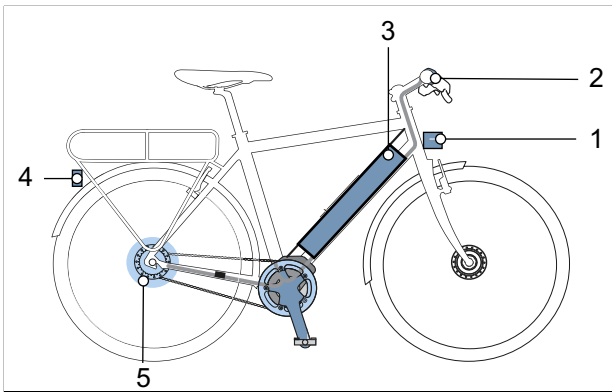

Figure 47: Diagram of an electric drive system with electric components

- | | |
|---|--|
| 1 | Front lamp |
| 2 | On-board computer |
| 3 | Rechargeable battery |
| 4 | Rear light |
| 5 | Motor |
| 6 | A charger which is designed for the battery (not shown). |

3.4.8.1 Motor

As soon as the muscle power required for pedalling passes a certain level, the motor is activated gently and assists the pedalling motion. The motor power always depends on the power used to pedal: Motor assistance is lower when little muscle power is used than when a great deal of muscle power is used. This happens regardless of the level of assistance.

The motor switches off automatically as soon as the rider no longer pedals, the temperature is outside the permitted range, there is an overload or the shut-off speed of 25 km/h has been reached.

A push assist system can be activated. The speed depends on the selected gear. The motor continues to drive the pedelec at walking speed as long as the rider presses the push assist button on the handlebars. The speed can be a maximum of 6 km/h in this case. The electric drive system stops when the push assist button is released.

The pedelec does not have a separate emergency shut-off button. In the event of an emergency, the motor can be stopped by removing the on-board computer. The mechanical brakes are used as an emergency stop system and bring the bicycle to a halt quickly and safely in the event of an emergency.

3.4.8.2 Charger

Each pedelec is supplied with a charger. Follow the charger operating instructions.

3.4.8.3 Lighting

Lighting always includes

- The front lamp (also known as headlight or front light)
- The rear light (also known as the rear lamp)

The headlight and the rear light are also on whenever the riding light is activated.

3.4.8.4 Rechargeable battery

FIT batteries are lithium ion batteries which are developed and manufactured to the latest technical standards. Each battery cell is protected by a steel cup and encased in a plastic battery housing. Applicable safety regulations are met.

- The battery has an interior electronic protection circuit, which is specifically designed for the charger and the pedelec.
- The battery temperature is monitored at all times.
- The battery is protected against deep discharge, overcharging, overheating and short circuit.

The battery has a high energy content when charged. The code of practice for their safe handling is found in Section 2 Safety and Section 6.9 Rechargeable battery in the operating instructions.

3.4.8.5 FIT Remote Basic on-board computer

The pedelec features a FIT Remote Basic on-board computer, which serves as a control panel.

The control panel on the handlebars uses 6 buttons to control the display.



Figure 48: FIT Remote Basic control panel

The pedelec battery powers the control panel.

Display

The on-board computer can be used with two different displays.



Figure 49: FIT Comfort 2.0 display



Figure 50: FIT Compact 2.0 display screen

The display switches off automatically if it is removed from its mount.

The display shows the main drive system functions and the ride data.

3.4.9 Handlebars with FIT Remote Basic with FIT Comfort or FIT Compact display

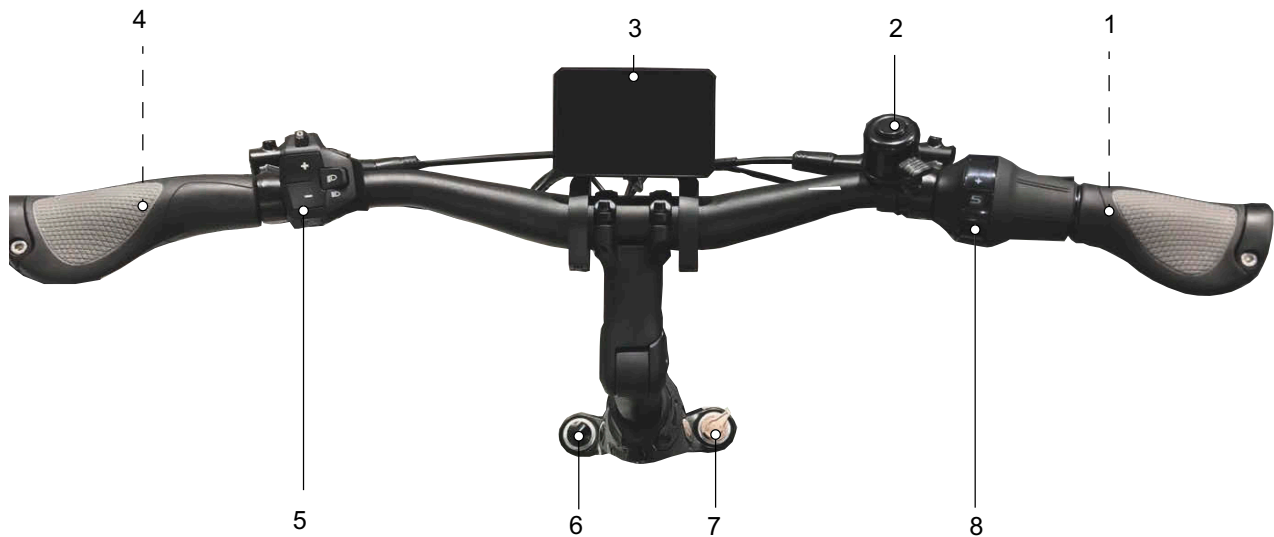

Figure 51: Detailed view of handlebars with FIT Remote Basic on-board computer and Compact 2.0 display, as example

1	Rear wheel hand brake (behind handlebars)	5	FIT Remote Basic on-board computer
2	Bell	6	Air valve
3	FIT Comfort 2.0 display	7	Lock out
4	Front wheel handbrake (behind handlebars)	8	Gear shift twist grip

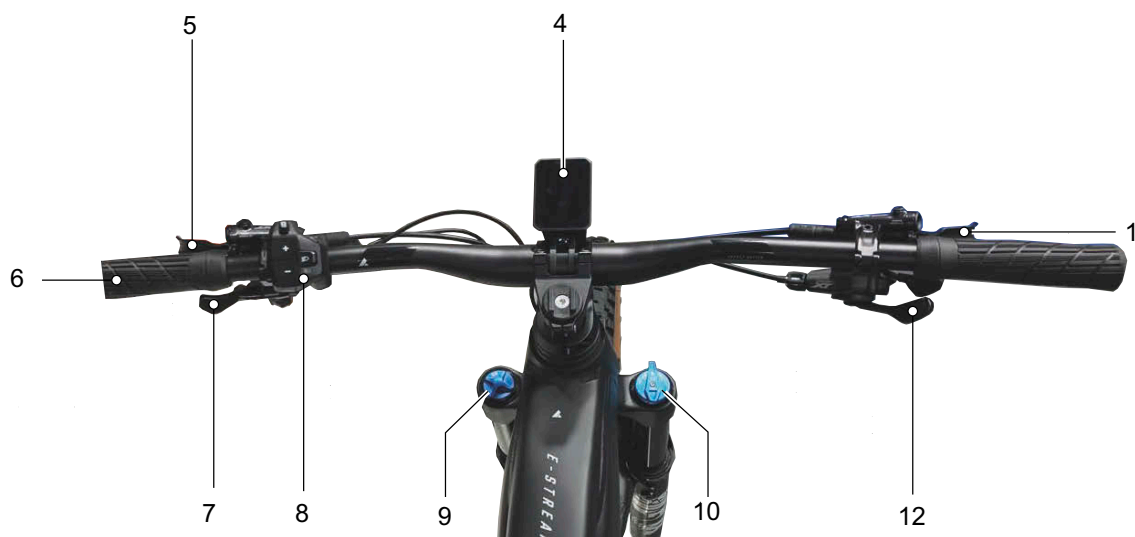

Figure 52: Detailed view of handlebars with FIT Remote Basic on-board computer and Compact 2.0 display

1	Rear wheel hand brake	8	FIT Remote Basic on-board computer
4	FIT Compact 2.0 display screen	9	Sag setting wheel
5	Front wheel handbrake	10	Fork lock, lockout
6	Handle	12	Shifter
7	Seat post remote control		

3.4.10 Control panel

The on-board computer is operated using six buttons on the control panel.

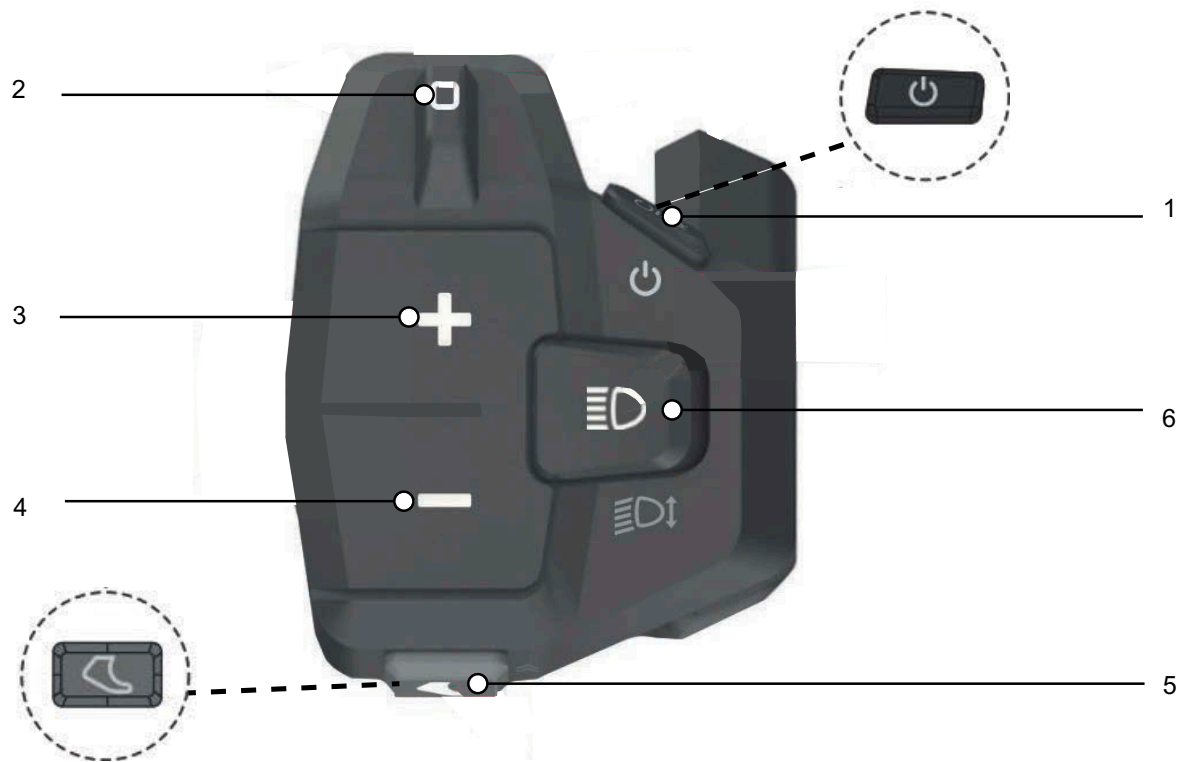

Figure 53: Overview of the BOSCH control panel

- 1 On-Off button (control panel)
- 2 Navigation rocker switch
- 3 Plus key
- 4 Minus key
- 5 Push assist button
- 6 Light button

3.5 Description of controls and screens

3.5.1 Display



Figure 54: FIT Comfort 2.0 display

There is a status LED in the top right-hand corner of the display screen.

If the display is switched on, the following menus are switched on one after another:

- DRIVE MAIN MENU
- DRIVE SUB-MENU
- TOUR MAIN MENU
- TOUR SUB-MENU
- FITNESS MAIN MENU
- AREA MAIN MENU

3.5.1.1 DRIVE MAIN MENU

The DRIVE MAIN MENU screen will appear as soon as the display is switched on.

The DRIVE MAIN MENU has six indicator elements which are the same for all screens.

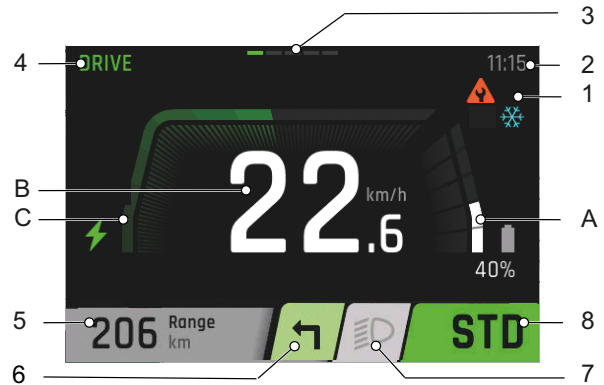

Figure 55: Overview of Drive main menu

- | | |
|---|---|
| 1 | Warnings indicator |
| 2 | Clock indicator |
| 3 | Guidance Bar indicator |
| 4 | Current Screen indicator |
| 5 | Range indicator |
| 6 | Navigation Instruction indicator (in connection with navigation app only) |
| 7 | Riding Light Symbol indicator |
| 8 | Level of assistance indicator |

The indicator elements in the middle (A, B and C) change for each different screen.

- | | |
|---|-------------------------|
| A | Battery level indicator |
| B | Current speed indicator |
| C | Motor power indicator |

1. Warnings indicator

A warning symbol is displayed here if there is an error or hazard. You will find more information in Section 6.2 System Messages.

2. Clock indicator

The time is displayed in either 12-hour or 24-hour format.

3. Guidance Bar indicator



The guidance bar will tell the rider which screen they are on. The screen that is open is highlighted.

4. Current Screen indicator

The name of the current screen is displayed in the Current Screen indicator.

5. Range indicator

The Range indicator shows trip distance that can be covered with the current battery level and ride mode.

6. Navigation Instruction indicator

The Navigation Instruction indicator will only be shown in connection with the navigation app.

7. Riding Light Symbol indicator

The following riding light symbols can be shown:



	Dimmed headlight (only applies to pedelecs with this equipment)
	Main beam (only applies to pedelecs with this equipment)
	Light off

Table 91: Overview of riding light symbols

8. Level of assistance indicator

The higher the level of assistance, the more the drive system assists the rider when pedalling.







Level of assistance	Use
	Maximum motor assistance. Suitable for sports riding up to high pedalling frequencies, e.g. on roads.
	Medium level of motor assistance. Suitable for sports riding on urban roads.
	Low level of motor assistance. Maximum efficiency for maximum range. The rider needs to apply the most force at this level of assistance.
	The system automatically selects the right assistance for the current riding conditions.
	When the drive system is switched on, the motor assistance is switched off. The pedelec can be used like a normal bicycle by simply pedalling. All screen functions can be accessed.
	In the [BOOST] level of assistance, the motor power can be increased to [HIGH] irrespective of the selected level of assistance. This function is only available in ride mode.

Table 92: Overview of levels of assistance

A. Battery level indicator

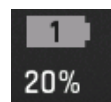

The Battery Level indicator can be read on the display screen and on the battery LEDs.

B. Current Speed indicator

The unit of speed is displayed in km/h or mph.

C. Motor Power indicator

The motor power used is displayed as a bar. The maximum motor power depends on the selected level of assistance.

3.5.1.2 DRIVE SUB-MENU

The indicator elements in the DRIVE SUB-MENU are the same as those in the DRIVE MAIN MENU.

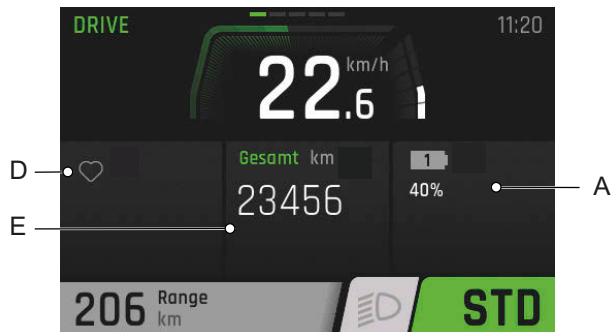

Figure 56: Drive sub-menu

- A Battery level indicator
- D Connection Status indicator
- E Total indicator

D. Connection Status indicator

The Connection Status indicator displays all auxiliary devices which are connected to the display screen.

- Connected devices display a green icon;
- Non-connected devices display a grey icon.

E. Total indicator

The Total indicator displays the overall distance that the vehicle has travelled on the odometer. This value cannot be reset.

3.5.1.3 TOUR MAIN MENU

The indicator elements in the TOUR MAIN MENU are the same as those in the DRIVE MAIN MENU.

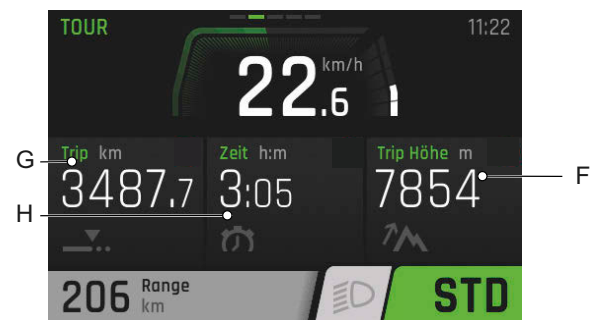

Figure 57: Overview of Tour main menu

- F Trip Height indicator
- G Trip indicator
- H Time indicator

F. Trip Height indicator

The Trip Height indicator displays the difference in altitude ridden since the last reset.

G. Trip indicator

The Trip indicator displays the number of kilometres travelled since the last reset.

H. Time indicator

The Time indicator displays the number of kilometres travelled since the last reset.

3.5.1.4 TOUR SUB-MENU

The indicator elements in the TOUR SUB-MENU are the same as those in the DRIVE MAIN MENU.



Figure 58: Overview of tour sub-menu 1

- I AVG indicator
- J MAX indicator
- K Cons. indicator

I. AVG indicator

The AVG indicator displays the average speed since the last reset.

J. MAX indicator

The MAX indicator displays the highest speed since the last reset.

K. Cons. indicator

The Tour Battery Consumption indicator displays the energy used since the last reset.

3.5.1.5 FITNESS MAIN MENU

The indicator elements in the FITNESS MAIN MENU are the same as those in the DRIVE MAIN MENU.



Figure 59: Overview of Fitness main menu

- L Power indicator
- M Cadence indicator
- N Consumption indicator

L. Power indicator

The Power indicator displays the power that the rider is currently applying to the pedals since the last reset in watts.

M. Cadence indicator

The Cadence indicator displays the current number of revolutions while pedalling.

N. Consumption indicator

The Consumption indicator displays the energy consumed since the last reset in kilocalories.

3.5.1.6 AREA MAIN MENU

The indicator elements in the AREA MAIN MENU are the same as those in the DRIVE MAIN MENU.



Figure 60: Overview of area main menu

- O Temp indicator
- P Height indicator
- Q Inclination indicator

O. Temp indicator

The Temperature indicator displays the current outdoor temperature in degrees Celsius.

P. Height indicator

The Height indicator displays the altitude above sea level.

Q. Inclination indicator

The Inclination indicator displays the gradient as a percentage.

3.5.1.7 SETTINGS MENU

All system and service-relevant values can be read and changed in the settings. The settings menu structure is customised and may change when components or services are added.

Menu	Submenu
Resetting the values	→ <Trip Reset>
	→ <Factory Reset>
Default settings	→ <Language>
	→ <Time>
	→ <Date>
	→ <Units>
	→ <Time Format>
Connectivity	→ <Connect Komoot>
	→ <Connect Heart Rate Sensor>°
MY Bike	→ <Assistance>
	→ <Calibration Altitude>
	→ <Auto Backlight>
	→ <Auto Power Off>
	→ <Vibration feedback>
Charge	→ <Normal Charge>
	→ <Fast Charge>
	→ <Charge to storage>
	→ <LONG-LIFE mode>
Errors	
About	

Table 93: Basic structure of FIT menu and sub-menu

– Resetting the values

Reset values.

→ <Trip Reset>

All values in the TOUR MAIN MENU and SUB-MENU are reset:

- Trip
- Time
- Trip Height
- Cons.
- MAX
- AVG

→ <Factory Reset>

Resets the system to the system's condition on delivery. All user data will be lost during reset.

– Default settings

Changes the display settings.

→ <Language>

Sets the language.

→ <Time>

Sets the clock.

→ <Date>

Sets the date.

→ <Unit>

The unit can be selected from the following variables:

Variable	Metric	Imperial
Distance	km	mi
Speed	km/h	mph
Energy consumption	Wh/km	Wh/mi
Temperature	°C	°F
Altitude above sea level	m.a.s.l.	ASL

Table 94: Units

→ <Time Format>

Displays time in either 12-hour or 24-hour format.

– Connectivity

→ <Connect Komoot>

→ <Connect Heart Rate Sensor>

– My Bike

→ <Assistance>

The motor output at the ECO, STANDARD and AUTO levels of assistance can set at the same time.

→ <Calibration Altitude>

Calibrates the altimeter. Altitude measurement depends on the air pressure and deviations may arise if the air pressure fluctuates.

→ <Auto Backlight>

This allows you to select between the display screen backlight adjusted to the ambient light or adjusted manually. The lighting brightness can be adjusted.

→ <Auto Power Off>

This sets the time after which the drive system will switch off automatically if it is not used.

→ <Vibration feedback>

This adjusts vibration feedback for the control panel:

Selection	Description
OFF	No vibration feedback
ON	Each press of a button and every active message produces vibration feedback
Only with messages	Vibration feedback is only produced for messages

Table 95: Vibration Feedback

– Charge

This sets the desired charge mode.

Selection	Description
Normal	Normal charging
Fast	Fast charging
Charge to Storage	The battery is charged for a longer storage period
LONG LIFE	Less battery capacity is available but the battery life is considerably longer

Table 96: Charge mode

– Errors

This gives access to the list of current error messages.

– About

This gives access to the software version of the individual components.

3.5.1.8 System message

The drive system monitors itself continuously and if an error is detected, it is indicated by a system message. The system may switch off automatically depending on the type of error. You will find assistance for system messages in [8.5 Initial help](#). There is a table of system messages in the Appendix.

3.5.2 Handbrake

There is a handbrake on the left and right of the handlebars.

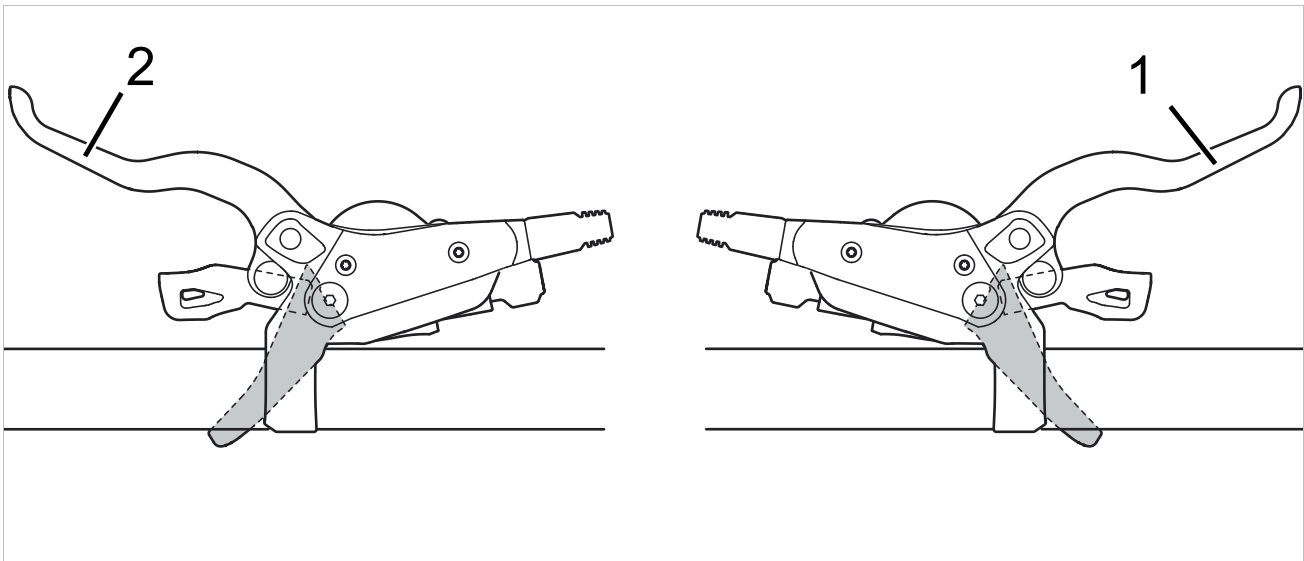

Figure 61: Front wheel (2) and rear (1) brake levers – Shimano brake used as an example

The left handbrake (2) controls the front wheel brake.

The right handbrake (1) controls the rear wheel brake.

3.5.3 Gear shift

3.5.3.1 Pinion, E-Trigger TE1

Only applies to vehicles with this equipment

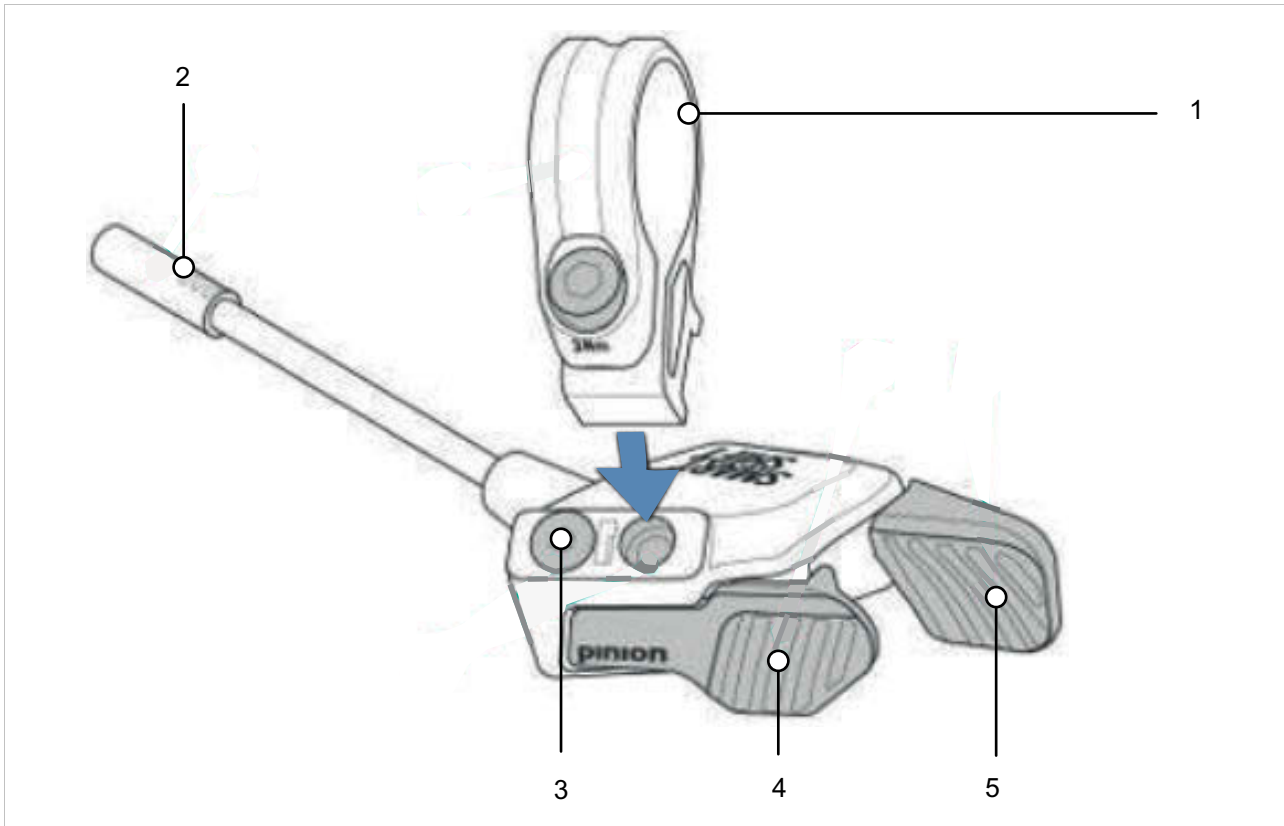

Figure 62: Parts of Pinion E-Trigger TE1

- 1 Ring clamp with screw
- 2 Connector
- 3 Screw-on position with blind screw
- 4 Front shifter
- 5 Rear shifter

Smart.Shift technology

Smart.Shift technology switches gear electrically and has two automatic settings.

SMART.SELECT

SMART.SELECT can be activated by selecting the <Shift> menu in the settings on the on-board computer. In this mode, the system shifts into the selected starting gear automatically when the bike comes to a halt. This ensures the pedelec starts up safely, saving energy.

PRE.SELECT

PRE.SELECT can be activated by selecting the <Shift> menu in the settings on the on-board computer. In this mode, the system automatically shifts into the perfect gear for the speed when the user rides without pedalling. This means that the user can pedal again when riding downhill without the pedals spinning uncontrolled or without the rider needing to shift up or down a gear several times. PRE.SELECT mode can be configured to the preferred pedalling frequency.

3.5.4 Suspension and damping

3.5.4.1 SR SUNTOUR air valve (fork) and sag setting wheel (fork)

Model	AIR EQ	AIR	COIL Adjustable	COIL
	Air valve (fork)	Air valve (fork)	Sag setting wheel	Sag setting wheel
Suspension	Air suspension	Air suspension	Steel spring	Steel spring
				
Rux		x		
Durolux	x			
Auron	x			
ZERON35		x	x	
Axon		x		
Epixon9	x			
Raidon		x		
XCR		x	x	
XCM		x	x	
XCT		x	x	
XCE			x	
M3010			x	x
Mobie45/34/25		x	x	
Mobie35	x			
MobieA32			x	
GVX		x		
NRX		x	x	
NCX32/NCX/TR-HSI		x	x	
NVX			x	
NEX			x	
CR			x	x

3.5.4.2 SR SUNTOUR adjuster damper

Only applies to vehicles with this equipment

Model	R2C2-PCS RC2-PCS RC2	3CR-PCS	2CR-PCS 2CR	RC-PCS RC
Suspension fork				
Aion		O		O
Durolux	O			O
Mobie34		x	O/x	
Mobie35		O	O	
Raidon			x	
Rux	O			
XCR			x	
Zeron35		x	x	x

x = fitted O = fitted in PCS piston

Explanation

R2C2-PCS	Rebound damper with high-speed and low-speed setting options and high-/low-speed compression damper in the piston compensator system
RC2-PCS	Rebound damper with low-speed setting option and high-/low-speed compression damper in the piston compensator system
RC2	Rebound damper with low-speed setting option and high-/low-speed compression damper
3CR-PCS	3-level compression damper and rebound damper with low-speed setting option in the piston compensator system
2CR-PCS	2-level compression damper and rebound damper with low-speed setting option in the piston compensator system
2CR	2-level compression damper and rebound damper with low-speed setting option
RC-PCS	Rebound damper with low-speed setting option and low-speed compression damper in the piston compensator system
RC	Rebound damper with low-speed setting option and low-speed compression damper

Model	LORC-PCS LORC	LOR
Suspension fork		
Aion	O	
Axon	O/x	
GVX		x
Mobie25		x
NRX		x
Raidon		x
X1		x
XCM		x
XCR		x
Zeron35		x

x = fitted O = fitted in PCS piston

Explanation

LORC-PCS	Rebound damper with low-speed setting option and low-speed compression damper with lockout in the piston compensator system
LORC	Rebound damper with low-speed setting option and low-speed compression damper with lockout
LOR	Rebound damper with low-speed setting option with lockout

3.5.4.3 SR SUNTOUR adjuster damper with remote control

Only applies to vehicles with this equipment

There is a remote control to open and close the damper on the handlebars.

Model	R-3CR-PCS R-2CR-PCS	RLRC-PCS	RLRC RLR
Suspension fork			
Aion	O	O	
Axon		O/x	
GVX			x
Mobie25			x
Mobie34	O		
NRX			x
Raidon	x		x
XCR	x		x
X1			x
Zeron35	x		x

x = fitted O = fitted in PCS piston

Explanation

R-3CR-PCS	3-level compression damper and rebound damper with low-speed setting option and lockout function on the handlebars in the piston compensator system
R-2CR-PCS	2-level compression damper and rebound damper with low-speed setting option and lockout function on the handlebars in the piston compensator system
RLRC-PCS	Low-speed rebound damper and low-speed compression damper and lockout function on the handlebars in the piston compensator system
RLRC	Rebound damper with low-speed setting option and low-speed compression damper and lockout function on the handlebars
RLR	Rebound damper with low-speed setting option and lockout function on the handlebars

3.5.5 Indicators on the battery

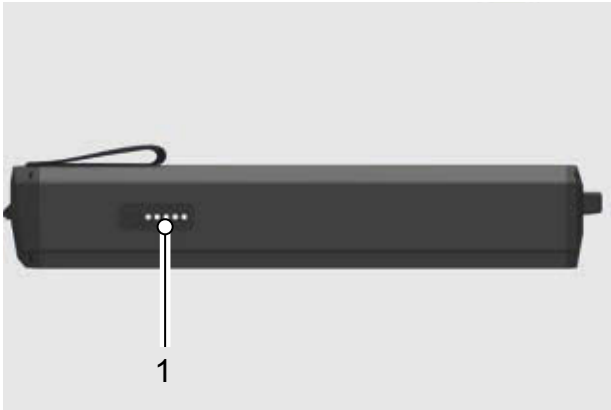

Figure 63: Battery level indicator position

The battery level indicator is on the battery.

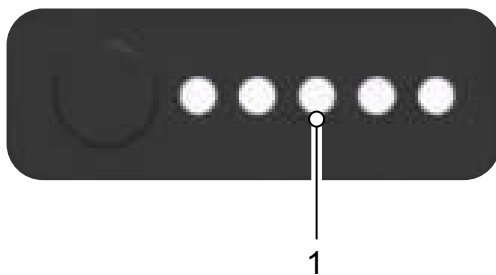

Figure 64: Overview of battery indicator display

1 Battery level indicator screen

3.5.5.1 Battery level indicator screen

The five LEDs on the **battery level indicator** show the charge level when the battery is switched on. Each LED represents 20% of the battery level. The charge level for the activated battery is also shown on the *display screen*.

If the battery level falls below 5%, all the LEDs on the battery level indicator will go out. However, the battery level is still shown on the *display screen*.

The five LEDs on **battery level indicator** show the charge level when the battery is switched on. Each LED represents 20% of the battery level.

● ● ● ● ●	100 ... 80%
● ● ● ○	79 ... 60%
● ● ○ ○	59 ... 40%
● ○ ○ ○	39 ... 20%
○ ○ ○ ○	19 ... 5%
○ ○ ○ ○	4 ... 0%

Table 97: Battery level indicator when discharging

● ● ● ● ●	0... 19%
○ ○ ○ ○ ○	20 ... 49%
○ ○ ○ ○ ○	40 ... 69%
○ ○ ○ ○ ○	60 ... 79%
○ ○ ○ ○ ○	80 ... 99%
● ● ● ● ●	100%

Table 98: Battery level indicator when charging

Symbols

● LED on	○ LED off	★ LED flashing
----------	-----------	----------------

The charge level for the activated battery is also shown on the *display screen*. If the battery level falls below 4%, all the LEDs on the battery level indicator will go out. However, the battery level is still shown on the *display screen*.

System errors and warnings are displayed by various light patterns on the **battery level indicator**. There is a table with all system messages in Section 6.2 System messages.

3.6 Transportation

CAUTION

Crash caused by unintentional activation

There is a risk of injury if the electric drive system is activated unintentionally.

- ▶ Remove the battery.

3.6.1 Using the transport securing system

Only applies to Pedelecs with disc brakes

CAUTION

Oil leak if no transport securing device

The brake securing device prevents the brakes from being applied accidentally during transportation or shipment. This could cause irreparable damage to the brake system or an oil leak, which will harm the environment.

- ▶ Never pull on handbrake when the wheel has been dismantled.
- ▶ Always use the transport securing system when transporting or shipping.

- ▶ Insert the **transport securing devices** between the brake linings.

⇒ Transport securing device is squeezed between the two linings and prevents undesired sustained braking which can cause brake fluid to leak out.

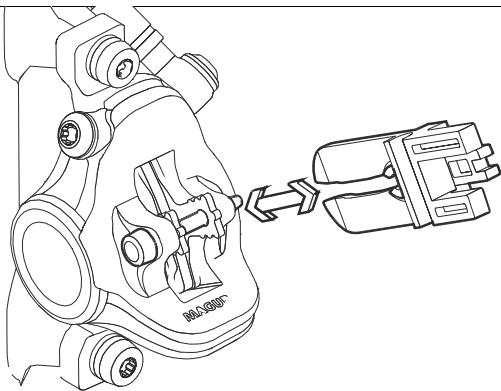

Figure 65: Fastening the transport securing device

3.6.2 Transporting the pedelec

Lithium-ion batteries store great amounts of energy. You must comply with a few precautionary measures when transporting gas cylinders.

- ▶ Discharge the battery to about 30% before placing pedelec in a vehicle to transport or take it on a trip.
- ▶ Recharge battery fully at destination.

3.6.2.1 By car

Bicycle rack systems which use the handlebars or frame to hold the pedelec in an upside-down position exert inadmissible forces on its components during transportation. This can cause the supporting parts to break.

- ▶ Remove battery and all detachable components (screen, bicycle pump, water bottle and similar) from the pedelec.
- ▶ Transport the battery in a dry, clean position where it is protected from direct sunlight.
- ▶ Never use bicycle rack systems which use the pedelec's handlebars or frame to hold the pedelec in an upside-down position. The specialist dealer will give a consultation on correct selection and safe use of a rack system.
- ▶ Take into account the weight of the ready-to-use pedelec when transporting it.

3.6.2.2 By train

Pedelecs can usually be transported in trains with a bicycle compartment.

- ✓ If you want to take your e-bike with you on the train, you should take into account that routes to platforms are not always barrier-free. You should thus allow enough time to get on and off the train.

- 1 Buy a bicycle ticket for the pedelec.
- 2 Fasten the pedelec securely in the compartment.
- 3 Take a seat in the passenger carriage.

It is possible to take a pedelec on certain high-speed train routes. The battery must remain firmly mounted during the journey and must not be charged.

3.6.2.3 By local transport

You can normally take pedelecs on local public transport, e.g. by bus or suburban rail, if you purchase a bike ticket. There may be times when this is not permitted. Local transport companies will give you relevant information.

3.6.2.4 By long-distance bus

Pedelecs can usually be taken on the long-distance bus for an extra charge, although places are limited. It is best to book early. However, not every bus line accepts pedelecs. You should check with the long-distance bus provider concerned before travelling.

3.6.2.5 On flights

It is forbidden to transport rechargeable batteries on passenger planes. Most airlines won't even transport pedelecs without batteries on passenger planes either.

It is a good idea to find out about pedelec leasing at your destination in advance if you wish to use a pedelec while on holiday. This way, you won't need to forgo pedelec riding fun during your holidays.

3.6.3 Shipping a pedelec

- ▶ Private users are not permitted to ship rechargeable batteries, neither by road nor by air freight.
- ▶ When shipping the pedelec, we recommend that you have the specialist dealer place it in proper packaging.

3.6.4 Transporting the battery

Batteries are subject to hazardous goods regulations. Undamaged batteries may be transported by private persons in road traffic.

Commercial transport operators must comply with regulations on packaging, labelling and the transportation of hazardous goods. Open contacts must be covered and the battery securely packaged.

3.6.5 Shipping the battery

The battery is considered a hazardous good and only trained persons may pack and ship a battery. Contact specialist dealer.

3.7 Storing

- ▶ Store pedelec, on-board computer, battery and charger in a clean, dry place where they are protected from sunlight. Do not store outdoors to ensure a long service life.

Optimum pedelec storage temperature	+10 ... +20 °C
--	----------------

Table 99: Optimum storage temperature for batteries and pedelec bikes

- ✓ Temperatures under -10 °C or over +40 °C must generally be avoided.
- ✓ Storage at about 10 °C to 20 °C is beneficial to a long battery life.
- ✓ Store pedelec, on-board computer, battery and charger separately.

3.7.1 Battery storage mode

Only applies to pedelecs with this equipment

The battery features a power-saving charge-to-storage mode, which minimises discharge from the battery.

- ▶ Setting the storage mode status in the settings.

3.7.2 Break in operation

Notice

The battery discharges when not in use. This can cause irreparable damage to the battery.

- ▶ The battery must be recharged every 6 months.

The battery may become damaged if it is connected permanently to the charger.

- ▶ Never connect the battery to the charger permanently.

The on-board computer battery discharges when it is not in use. This can cause irreparable damage to it.

- ▶ Recharge the on-board computer battery for at least 1 hour every 3 months.

- ▶ Remove the on-board computer from its mount if the pedelec is not going to be used for up to four weeks. Store the on-board computer away safely in a dry environment at room temperature.

- ▶ If the pedelec is removed from service for longer than four weeks, you need to prepare it for a break in operation.

3.7.2.1 Preparing a break in operation

- ✓ Remove the rechargeable battery from the pedelec. Charge battery to about 30%–60%.
- ✓ The pedelec needs to be cleaned with a damp cloth and preserved with wax spray. Never wax the friction surfaces of the brake.
- ✓ Before longer periods without use, it is recommendable to have your specialist dealer carry out an inspection and basic cleaning and apply preservative agent.
- ✓ Pump tyres to maximum pressure. The side wall will be squashed and damaged if the pedelec stands on flat tyres.

3.7.2.2 Carrying out a break in operation

- 1 Store the pedelec, battery and charger in a dry, clean environment. We recommend storing them in uninhabited rooms with smoke alarms. Dry locations with an ambient temperature between 10 °C and 20 °C are ideal.
- 2 Check the battery level after 6 months. If only one LED on the battery level indicator lights up, recharge the battery to around 30%–60%.
- 3 Recharge the display battery for at least 1 hour every 3 months.
- 4 Check the tyre pressure with an air gauge on a regular basis.
- 5 Check brake on a regular basis.
- 6 Deflect suspension fork and rear frame damper regularly to ensure a little oil reaches the seals and the suspension elements remain smooth.



5 Assembly

WARNING

Risk of eye injury

Problems may arise if components are set incorrectly. They may cause serious injuries to the face.

- ▶ Always wear safety glasses to protect eyes when assembling pedelecs.

CAUTION

Crash and crushing hazard caused by unintentional activation

There is a risk of injury if the electric drive system is activated unintentionally.

- ▶ Remove the battery.

- ✓ Assemble the pedelec in a clean, dry environment.
- ✓ The work environment temperature should be between 15 °C and 25 °C.
- ✓ The fitting stand used must be approved for a maximum weight of least 30 kg.

5.1 Unpacking

The packaging material consists mainly of cardboard and plastic film.

- ▶ Dispose of the packaging in accordance with the regulatory requirements (see Section 10).
- ⇒ Pedelecs are fully assembled in the factory for test purposes and then dismantled for transportation. The pedelec is 95% to 98% pre-assembled.

Scope of delivery

<input type="checkbox"/>	1 × pre-assembled pedelec
<input type="checkbox"/>	1 × front wheel
<input type="checkbox"/>	2 × pedals
<input type="checkbox"/>	2 × quick releases (optional)
<input type="checkbox"/>	1 × charger
<input type="checkbox"/>	1 × set of operating instructions on CD
<input type="checkbox"/>	1 × battery (supplied separately from the pedelec)

5.2 Required tools

The following tools are required to assemble the pedelec:

	Knife
	Ring spanners 8 mm, 9 mm, 10 mm, 13 mm, 14 mm and 15 mm
	Torque wrench Working range 5... 40 Nm
	by.schulz handlebars: TORX® bits: T50, T55, and T60
	Hex key 2 mm, 2.5 mm, 3 mm, 4 mm, 5 mm, 6 mm and 8 mm
	Cross-recess screwdriver
	Slotted-head screwdriver

Table 100: Tools required for assembly



5.3 Commissioning

Only trained specialist staff may perform initial commissioning since initial commissioning of the pedelec requires special tools and specialist knowledge.

Experience has shown that a pedelec which has not yet been sold is automatically handed to customers as soon as it appears ready to ride.

It makes sense to prepare each pedelec so that it is fully ready for use immediately after being assembled.

- ▶ Complete an assembly report to document quality assurance (see Section 11.1).
- ▶ Carry out all possible assembly work specified on the assembly report.
- ▶ Record all actions completed on the assembly report.

5.3.1 Checking the battery

The battery must be checked before it is charged for the first time.

- ▶ Press the **On-Off button (battery)**.
- ⇒ If none of the LEDs on the **battery level indicator** light up, the battery may be damaged.
- ⇒ The battery may be fully charged if at least one, but not all, of the LEDs on the **battery level indicator** lights up.



5.3.2 Adjusting the LIMOTEC seat post

Only applies to pedelecs with this equipment

- ✓ The rider's body weight exceeds or falls below the seat post's functional weight.
- 1 Order new Limotec seat post with suitable functional weight.
- 2 Remove existing seat post.

Replacing Limotec A1 and A5

- 3 Use the seat height formula to calculate the optimum seat post height for leg length:
Seat height (SH) = inner leg length (I) \times 0.9
- 4 Lower the seat post further into the seat tube.
- 5 Tighten the seat post Bowden cable in the frame up to the remote control to the same length as the seat post was lowered.
- 6 Trim the seat post Bowden cable on the handlebars if necessary.



5.3.3 Preparing the wheel

There is an arrow on the sides of the tyres with the inscription ROTATION to show the direction of rotation. The inscription says DRIVE on older tyres. The rotation direction arrow indicates the recommended direction of rotation. On road tyres, the direction of rotation is mainly for optical reasons.



Figure 66: Rotation direction arrow

The direction of rotation is much more important on off-road terrain because the tread creates an interlock with the ground. While the rear wheel needs to transmit the drive forces, the front wheel is responsible for transmitting braking and steering forces. Drive and braking forces have different directions of action. This is why some tyres are mounted on the front and rear wheels in opposite directions. On these tyres, there are two rotation direction arrows:

- The FRONT rotation direction arrow indicates the recommended direction of rotation for the front wheel.
- The REAR rotation direction arrow indicates the recommended direction of rotation for the rear wheel.



Figure 67: Rotation direction arrow on MTB tyres

- ▶ The rotation direction arrow must point in the direction of travel when the wheel is placed in the fork.
- ▶ There are also non-directional tyre profiles with no rotation direction arrow.



5.3.4 Installing the wheel in the SUNTOUR fork

Only applies to Suntour forks with this equipment

5.3.4.1 Screw-on axle (12AH2 and 15AH2)

Only applies to Suntour forks with this equipment

✓ Before installing the wheel, ensure that the O-ring is in the right position on the thread piece.

- 1 Insert the front wheel into the fork ends.
- 2 Insert the axle into the hub on the drive side.

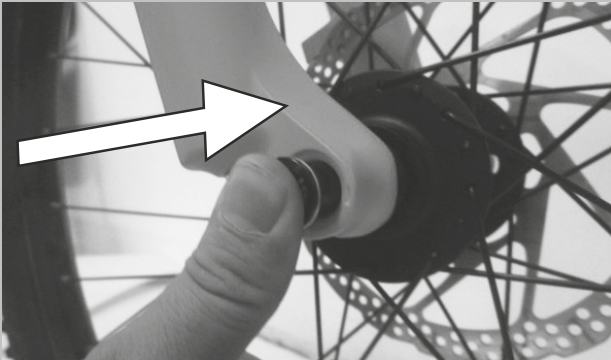

Figure 68: Inserting the axle in the direction of the arrow

- 3 Use a 6 mm hex key to tighten the axle using between 8 and 10 Nm. The axle thread must be visible.

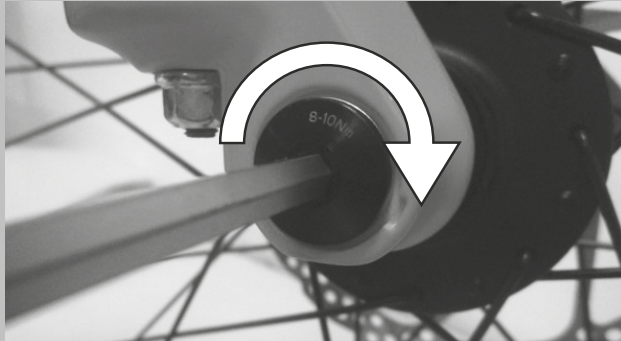

Figure 69: Tighten the axle in the direction of the arrow

- 4 Insert the securing screw on the non-drive side.

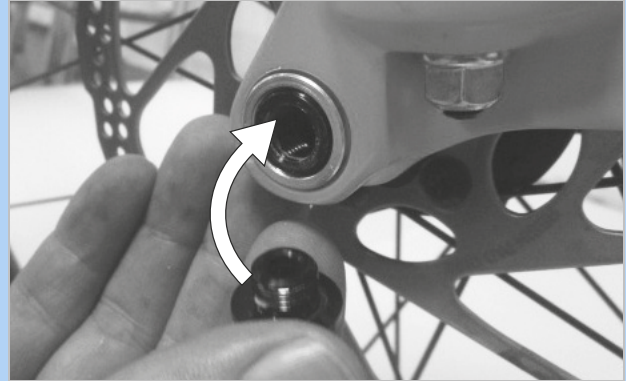

Figure 70: Inserting the securing screw

- 5 Tighten the securing screw with a 5 mm hex key using between 5 and 6 Nm.



Figure 71: Tightening the securing screw

⇒ The wheel is now fitted.



5.3.4.2 20 mm cross axle

Only applies to Suntour forks with this equipment

CAUTION

Crash caused by loose cross axle

A faulty or incorrectly installed cross axle may become caught in the brake disc and block the wheel. This will cause a crash.

- ▶ Never fit a defective cross axle.

Crash caused by faulty or incorrectly installed cross axle

The brake disc becomes very hot during operation. Parts of the cross axle may become damaged as a result. The cross axle becomes loose. This will cause a crash with injuries.

- ▶ The cross axle and the brake disc must be opposite one another.

Crash caused by incorrectly set cross axle

Insufficient clamping force will result in unfavourable transmission of force. The suspension fork or the quick release axle may break. This will cause a crash with injuries.

- ▶ Never fasten the cross axle with a tool (e.g. hammer or pliers).

- 1 Insert the cross axle into the hub on the drive side.

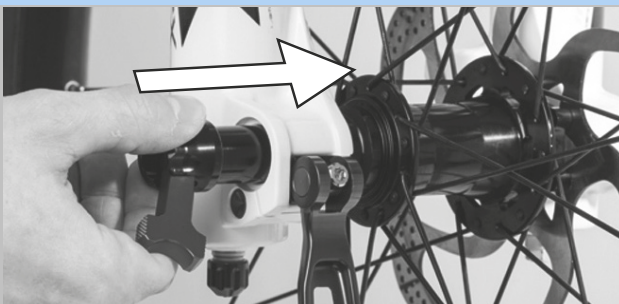

Figure 72: Inserting the cross axle in the direction of the arrow

- 2 Tighten the cross axle with the red handle.

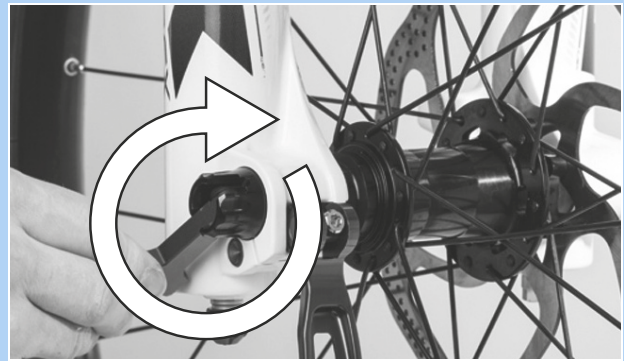

Figure 73: Tighten the axle in the direction of the arrow

- 3 Push red lever into the cross axle.

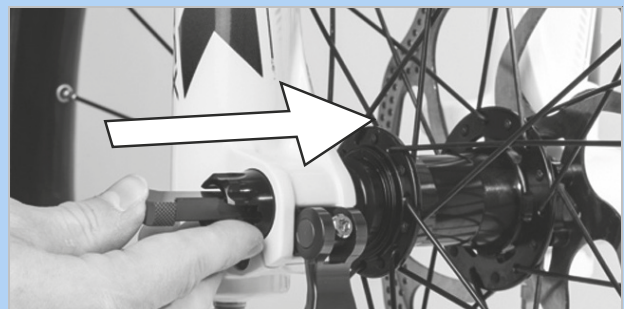

Figure 74: Pushing the red lever in the direction of the arrow

- 4 Closing the quick release lever.



Figure 75: Pressing the quick release lever in the direction of the arrow

- ⇒ The cross axle is secured.



- 5 Check the position and clamping force of the quick release lever. The quick release lever must be flush with the shock absorber.

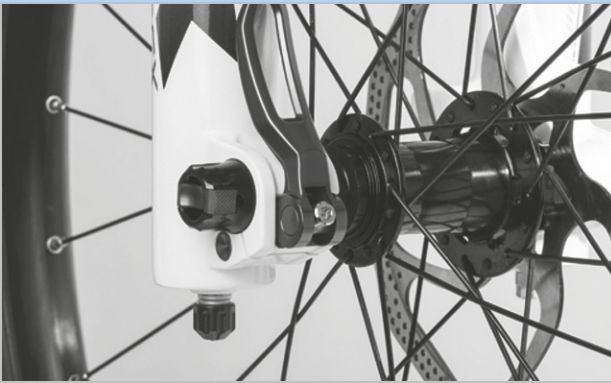

Figure 76: Perfect position for the clamping lever

- 6 Use 4 mm hexagon socket spanner to adjust the clamping lever clamping force if required.

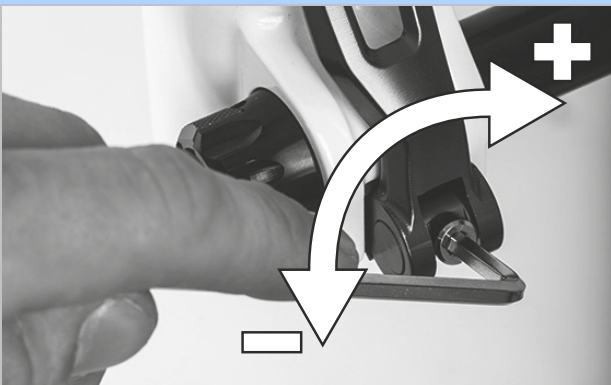

Figure 77: Adjusting the quick release clamping force

- 7 Check the quick release lever position and clamping force.

⇒ The wheel is now fitted.



5.3.4.3 Q-LOC quick release

Only applies to Suntour forks with this equipment

CAUTION

Crash caused by unfastened quick release

A faulty or incorrectly installed quick release may become caught in the brake disc and block the wheel. This will cause a crash.

- ▶ Never fit a defective quick release.

Crash caused by faulty or incorrectly installed quick release

The brake disc becomes very hot during operation. Parts of the quick release may become damaged as a result. The quick release comes loose. This will cause a crash with injuries.

- ▶ The front wheel quick release lever and the brake disc must be situated on opposite sides.

Crash caused by incorrectly set clamping force

Excessively high clamping force will damage the quick release and cause it to lose its function. Insufficient clamping force will result in unfavourable transmission of force. The suspension fork or the quick release may break. This will cause a crash with injuries.

- ▶ Never fasten a quick release using a tool (e.g. hammer or pliers).
- ▶ Only use the clamping lever with the specified set clamping force.

- ✓ Before installing, ensure that the quick release flange is extended. Open the lever fully.

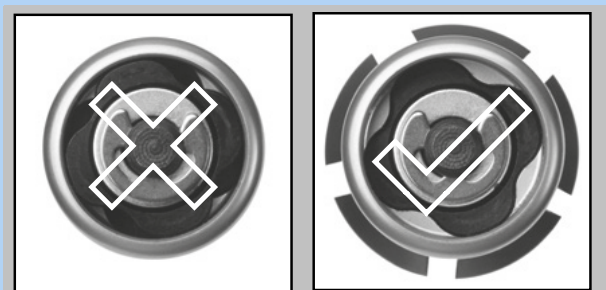

Figure 78: Closed and opened flange

- 1 Push in the quick release until you can hear a click. Make sure that the flange is extended.

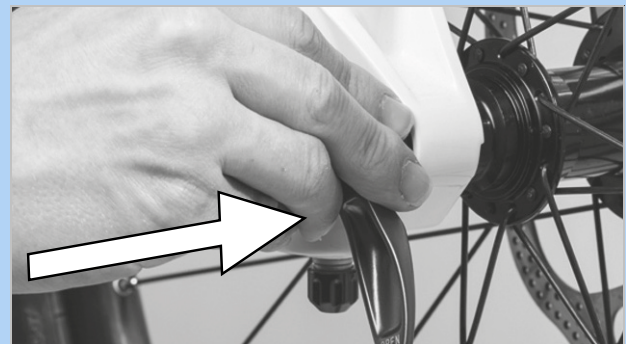

Figure 79: Inserting the quick release in the direction of the arrow

- 2 Adjust tensioning with half-open clamping lever until the flange reaches the fork end.

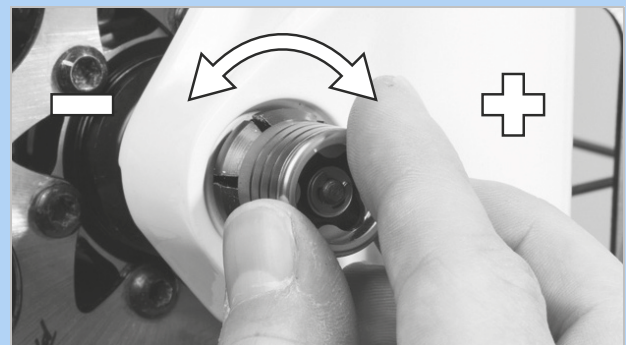

Figure 80: Adjusting the clamping

- 3 Fully close the quick release. Check that it is firmly in place and adjust it on the flange if necessary.



Figure 81: Closing the quick release

- ⇒ The wheel is now fitted.



5.3.5 Checking the stem and handlebars

5.3.5.1 Checking the connections

- 1 Stand in front of the pedelec. Clamp the front wheel between your legs. Grasp the handlebar grips.
- 2 Try to twist the handlebars against the direction of the front wheel.
 - ⇒ The stem must not move or twist.
- 3 If the stem can be twisted, check fastening.
 - ⇒ If the stem cannot be fastened, contact your specialist dealer.

5.3.5.2 Checking stem is firmly in position

- 1 Press full body weight on the handlebars.
 - ⇒ The handlebars must not move downwards in the fork.

Stem with clamping lever version I

- 2 If the handlebars should move, increase the lever tension in the clamping lever.
- 3 Turn knurled nut in a clockwise direction with the clamping lever open.
- 4 Close clamping lever and check stem is firmly in position again.
- 5 If the handlebars cannot be fastened, contact your specialist dealer.

Stem with clamping lever version II and stem with screw

- ▶ If the handlebars cannot be fastened, contact your specialist dealer.

5.3.5.3 Checking the bearing clearance

- 1 Place the fingers of one hand on the upper headset cup. Pull the front wheel brake with the other hand and try to push the pedelec backwards and forwards.
 - Keep in mind that there may be noticeable backlash due to worn-out bearing bushes or brake lining backlash in suspension forks and disc brakes.
 - ⇒ The headset cup halves must not move towards one another.
- 2 Adjust bearing clearance as per the stem repair manual as quickly as possible; otherwise, the bearing will become damaged. Contact specialist dealer.

5.4 Selling the pedelec

- ▶ Complete pedelec pass on the operating instructions envelope.
- ▶ Note down the manufacturer and the number of the battery key.
- ▶ Adjust the stand and shifter.
- ▶ [Adjusting the pedelec](#) (see Section 6.4).
- ▶ Briefly instruct pedelec rider on all the pedelec's functions (see Section 6.7 to Section 6.18.2).

5 Assembly instructions for online sales

Your specialist dealer will complete assembly and commissioning for this pedelec. The pedals were unscrewed and the handlebars repositioned before transportation. You need these instructions to get your pedelec roadworthy and ready for use after transportation.



Crash caused by incorrectly adjusted torques

If a screw is fastened too tightly, it may break. If a screw is not fastened enough, it may loosen. This will cause a crash with injuries.

- ▶ Always observe the indicated torques on the screw, the component and in the operating instructions.
- ▶ Prior knowledge is required for assembly. If you don't have any prior knowledge, contact specialist dealer.

Crash and crushing hazard caused by unintentional activation

There is a risk of injury if the drive system is activated unintentionally.

- ▶ Remove the battery.

5.0.1 Unpacking

- ▶ The packaging material consists of cardboard. The packaging has to be disposed of in accordance with the regulations of the authorities.

Scope of delivery

<input type="checkbox"/>	1 pedelec with battery
<input type="checkbox"/>	2 pedals (already greased)
<input type="checkbox"/>	1 charger
<input type="checkbox"/>	1 set of operating instructions on CD

5.0.2 Preparing

- ▶ Assemble the pedelec in a clean, dry environment. The work environment temperature should be between 15 °C and 25 °C.
- ▶ Secure the pedelec in a fitting stand. The fitting stand used must be approved for a maximum weight of least 30 kg. Alternatively, you can get another person to hold the pedelec.
- ▶ Read the operating instructions for your pedelec.

5.0.3 Required tools

The following tools are required to assemble the pedelec:



	Screw wrench 15 mm
	Torque wrench Working range: 5- 40 Nm
	by,schulz handlebars: Torx bits: 4 mm, 5 mm and 6 mm If not: Hexagon bits: 4 mm, 5 mm and 6 mm

Table 101: Tools required for assembly

5.0.4 Straightening the handlebars

The handlebars must be turned so that they are parallel to the frame and tyres for transportation.

- 1 Turn handlebars clockwise until they are vertically aligned with the wheel and frame.
The way the handlebar is secured depends on the stem.

5.0.4.1 Stem with clamping lever version I

Only applies to pedelecs with this equipment

- 1 Open the clamping lever on the stem quick release.
- 2 Pull the locking lever on the stem upwards and simultaneously pivot handlebars 90° to the left.
⇒ You feel the handlebars click into place.
- 3 Push in the handlebars.
- 4 Close the clamping lever on the stem quick release.



Figure 82: Opened clamping lever on the stem quick release (3) on the stem (2), version I, with locking lever on the stem (1)

5.0.4.2 Stem with clamping lever version II

Only applies to pedelecs with this equipment

- 1 Open the clamping lever on the stem quick release.
- 2 Push the *unlocking knob*.
- 3 Pivot the *handlebars* 90° to the right or left.
⇒ You feel the *handlebars* click into place.
- 4 Close the *clamping lever on the stem quick release*.



Figure 83: Stem, version II with clamping lever on the stem quick release (1) and unlocking knob (2)

5.1 Stem with screw

Only applies to pedelecs with this equipment

- 1 Remove the safety cap from the stem.
- 2 Undo the screw using a 4 mm, 5 mm, or 6 mm Torx or hex key, depending on the type of screw.
- 3 Turn the handlebars into the required position.
- 4 Fasten the screw using a 4 mm, 5 mm, or 6 mm Torx or hex key, depending on the type of screw.
- 5 Refasten the safety cap on the stem.

5.1.1 Checking the stem and handlebars are in correct position

5.1.1.1 Checking the connections

- 1 Stand in front of the pedelec. Clamp the front wheel between your legs. Grasp the handlebar grips.
 - 2 Try to twist the handlebars against the direction of the front wheel.
- ⇒ The stem must not move or twist.
- 3 If the stem can be twisted, check fastening.
- ⇒ If the stem cannot be fastened, contact your specialist dealer.

5.1.1.2 Checking stem is firmly in position

- 1 Press full body weight on the handlebars.
- ⇒ The handlebars must not move downwards in the fork.

Stem with clamping lever version I

- 2 If the handlebars should move, increase the lever tension in the clamping lever.
- 3 Turn knurled nut in a clockwise direction with the clamping lever open.
- 4 Close clamping lever and check stem is firmly in position again.
- 5 If the handlebars cannot be fastened, contact your specialist dealer.

Stem with clamping lever version II and stem with screw

- If the handlebars cannot be fastened, contact your specialist dealer.

5.1.1.3 Checking the bearing clearance

- 1 Place the fingers of one hand on the upper headset cup. Pull the front wheel brake with the other hand and try to push the pedelec backwards and forwards.
Keep in mind that there may be noticeable backlash due to worn-out bearing bushes or brake lining backlash in suspension forks and disc brakes.
- ⇒ The headset cup halves must not move towards one another.
- 2 Set bearing clearance as per the stem repair manual as quickly as possible as otherwise the bearing will become damaged. Contact specialist dealer.

5.1.2 Fitting the pedals

The pedals have two different threads to ensure they don't come loose while the rider is pedalling.

- The pedal on the left facing the direction of travel has a left-hand thread and is marked L.
- The pedal on the right facing the direction of travel has a right-hand thread and is marked R.

The mark is either on the top end, the axle or the pedal body.



Figure 84: Example of markings on pedals

- 1 Coat threads in both pedals with waterproof grease.
- 2 Turn the pedal marked L anti-clockwise by hand into the crank arm on the left as seen when facing the direction of travel.



Figure 85: L pedal in the left-hand crank arm

- 3 Turn the pedal marked R anti-clockwise by hand into the crank arm on the right as seen when facing the direction of travel.



Figure 86: R pedal in the right-hand crank arm

- 4 Use a 15 mm spanner to fasten the left-hand pedal thread in an anti-clockwise direction and the right-hand pedal in a clockwise direction with a torque between 33 and 35 Nm.

6 Operation

6.1 Risks and hazards

WARNING

Injuries and death caused by blind spots

Other road users, trucks, cars and pedestrians often underestimate the speed of pedelecs. Likewise, other road users frequently do not see pedelecs. This may lead to an accident with serious injuries or even death.

- ▶ Wear a helmet. The helmet must have a reflective strip or a light in a clearly visible colour.
- ▶ Clothing should be retroreflective or as light as possible. Fluorescent materials are also suitable. High-visibility jackets and straps on your upper body ensure even greater safety.
- ▶ Always take a defensive approach to riding.
- ▶ Avoid the blind spots of vehicles turning off the road. Reduce speed as a precaution when other road users turn right.

Injuries and death caused by riding incorrectly

A pedelec is not a bicycle. Mistakes made while riding and underestimated speeds quickly lead to hazardous situations. This can cause an accident with serious or fatal injuries.

- ▶ Slowly get used to road traffic and speed before riding at speeds over 12 km/h, especially if you have not ridden a bike for some time.
- ▶ Increase the levels of assistance gradually.
- ▶ Practice braking hard on a regular basis.
- ▶ Take and complete a riding safety course.

WARNING

Injuries and death caused by distraction

A lack of concentration while riding increases the risk of an accident. This may cause a crash with serious injuries.

- ▶ Never allow yourself to be distracted by the on-board computer or your smartphone.
- ▶ Stop pedelec if you want to make inputs on the on-board computer other than change the level of assistance. Only enter data when stationary.

CAUTION

Crash caused by loose clothing

Laces, scarves and other loose items may become entangled in the spokes on the wheels and the chain drive. This may cause a crash with injuries.

- ▶ Wear sturdy footwear and close-fitting clothing.

Crash caused by difficult-to-spot damage

If the pedelec topples over or you have a fall or an accident, there may be difficult-to-spot damage to components such as the brake system, quick releases or frame. This may cause a crash with injuries.

- ▶ Take pedelec out of service. Contact specialist dealer.

Crash caused by soiling

Heavy soiling can impair pedelec functions, such as braking. This may cause a crash with injuries.

- ▶ Remove coarse soiling before riding.

CAUTION

Crash caused by material fatigue

Intensive use can cause material fatigue. A component may suddenly fail in case of material fatigue. This may cause a crash with injuries.

- ▶ Remove the pedelec from service immediately if there are any signs of material fatigue. Have your specialist dealer inspect the component.
- ▶ Arrange the mandatory inspection appointments with your specialist dealer on a regular basis. During the major inspection, the specialist dealer will inspect the pedelec for any signs of material fatigue on the frame, fork, suspension element mountings (if there are any) and components made of composite materials.

Carbon becomes brittle when exposed to heat radiation such as heating. This can cause the carbon part to break and result in a crash with injuries.

- ▶ Never expose carbon components parts on the pedelec to strong sources of heat.

Crash caused by poor road conditions

Loose objects, such as branches and twigs, may become caught in the wheels and cause a crash with injuries.

- ▶ Be aware of the road conditions.
- ▶ Ride slowly and brake in good time.

The *tyres* may slip on wet roads. In wet conditions you must also expect a longer braking distance. The braking sensation differs from the usual sensation. This can cause loss of control or a crash, which may result in injuries.

- ▶ Ride slowly and brake in good time when it is raining.

Notice

Heat or direct sunlight can cause the *tyre pressure* to increase above the permitted maximum pressure. This can destroy the *tyres*.

- ▶ Park pedelec in the shade.
- ▶ On hot days, regularly check the *tyre pressure* and adjust it as necessary.

When riding downhill, high speeds may be reached. The pedelec is only designed to exceed a speed of 25 km/h for short intervals. The *tyres* in particular can fail if exposed to a continuous load.

- ▶ Use the brakes to decelerate the pedelec if you reach speeds greater than 25 km/h.

Moisture penetrating at low temperatures may impair individual functions due to the open structural design.

- ▶ Always keep the pedelec dry and free from frost.
- ▶ If the pedelec is used at temperatures below 3 °C, the specialist dealer must perform a major inspection beforehand and prepare it for winter use.

Off-road riding subjects the joints in the arms to severe strain.

- ▶ Take a break from riding every 30 to 90 minutes, depending on the road surface conditions and your physical fitness.

6.2 Tips for a greater range

The pedelec's range depends on many influencing factors. A single battery charge may only last fewer than 20 kilometres but much more than 100 is also possible. Test the pedelec's range before embarking on longer rides. There are a few tips which will generally help you maximize range.

Suspension elements

- ▶ Only open suspension fork and damper when necessary on terrain or gravel paths. Block suspension fork and damper on tarmacked roads or on hills.

Mileage

The more own physical effort the rider makes, the greater the attainable range is.

- ▶ Shift down 1 to 2 gears to increase the induced power and pedalling frequency.

Pedalling frequency

- ▶ Ride using pedalling frequencies of over 50 revolutions per minute. This optimises the electric drive's efficiency.
- ▶ Avoid pedalling very slowly.

Weight

- ▶ Minimise the total weight of pedelec and baggage.

Stopping and starting

- ▶ Ride long distances at a constant speed.
- ▶ Avoid stopping and starting frequently.

Level of assistance

- ▶ The lower the selected level of assistance is, the greater the range is.

Gear switching habits

- ▶ Use a low gear and a low level of assistance on hills and when setting off.
- ▶ Switch up a gear depending on the speed and terrain.
- ▶ 50-80 crank rotations per minute are optimal.
- ▶ Avoid high stress loads on the crank during a gear change.
- ▶ Switch gear back in good time, e.g. before inclines.

Tyres

- ▶ Always select the right tyres for the surface type. As a general rule, narrower treads move along more easily than heavier ones. Long studs and large grooves usually have an unfavourable effect on energy consumption.
- ▶ When riding on asphalt, it is important to always use the maximum permitted tyre pressure.
- ▶ When riding off-road, on gravel tracks or soft woodland or meadow soils, it is important to remember: the lower the tyre pressure is, the greater the rolling resistance is and thus the greater electric drive system energy consumption is.

Rechargeable battery

Electrical resistance increases as the temperature drops. Battery performance is reduced. As a result, you should expect the range to be shorter than normal in winter.

- ▶ Use a thermal protection sleeve on the battery in winter.

The range also depends on the battery's age, charge level and state of repair.

- ▶ Maintain the battery and replace older batteries where necessary.

6.3 Instruction and customer service

The supplying specialist dealer will provide customer service. Contact details can be found on the pedecec pass for these operating instructions. The specialist dealer will explain all the pedecec functions to the new owner in person, this being when the specialist dealer hands over the pedecec at the latest. These operating instructions are provided with every pedecec, so that the rider can consult them at a later stage.

The supplying specialist dealer will also perform all inspection, modifications and repairs in the future.

6.4 Adjusting the pedecec



Crash caused by incorrectly adjusted torque

If a screw is fastened too tightly, it may break. If a screw is not fastened enough, it may loosen. This will cause a crash with injuries.

- Always observe the torque indicated on the screw and in the operating instructions.

Only a correctly adjusted pedecec will guarantee the desired ride comfort and health-promoting activity.

All settings must be re-configured if the body weight or maximum baggage weight changes.

6.4.1 Preparing

The following tools are required to adjust the pedecec:









	Tape measure
	Scales
	Spirit level
	Ring spanners 8 mm, 9 mm, 10 mm, 13 mm, 14 mm und 15 mm
	Torque wrench Working range 5... 40 Nm
	Hex key 2 mm, 2.5 mm, 3 mm, 4 mm, 5 mm, 6 mm and 8 mm
	Cross-recess screwdriver
	Slotted-head screwdriver

Table 102: Tools required for assembly

6.4.2 Determining the sitting position

The starting point for a comfortable posture is the correct position of the pelvis. If the pelvis is in the wrong position, it can cause different types of pain, e.g. in the shoulder or back.

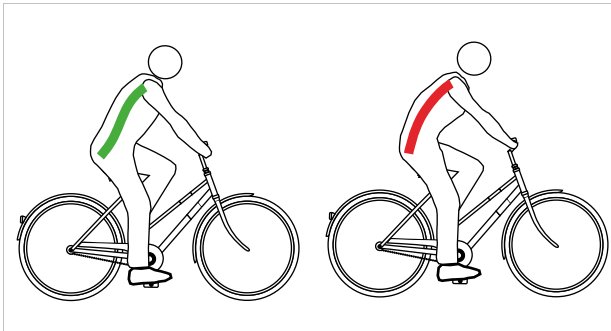

Figure 87: The pelvis is in the right position (green) or incorrect position (red)

The pelvis is in the right position if the spine forms an S-shape and a natural, easy arch.

The pelvis is positioned incorrectly if it tilts slightly backwards. As a result, the spine becomes curved and can no longer deflect to an optimal extent.

A suitable sitting position must be selected beforehand depending on the pedelec type, physical fitness and desired trip distance or speed.

It is especially advisable to check and optimise the sitting position once more before longer rides.

Position on roadster	Position on city bike
Angle of upper body (black dashed line)	
Upright, almost vertical posture, back at an angle of almost 90°. Handlebars and handles are very close to the upper body.	Slightly inclined upper body, back at an angle of 60°...70°.
Upper arm-upper body angle (red line)	
Extremely acute angle at around 20°. The upper arms are almost parallel to the upper body. Hands are simply placed loosely on the handlebars.	An angle of 75°–80° is optimum. Many people prefer a smaller angle of up to 60° as it requires less effort to support the shoulders, arms and hands.
Saddle-handlebar height difference [cm] (blue and green line)	
>10 The handlebars are positioned far higher than the saddle.	10 to 5 The handlebars are positioned higher than the saddle.
Benefits	
The spine is intuitively moved into its natural S-shape. The strain on arms and hands is very slight – no effort required to support.	The upright position provides a good overview in traffic. Force can be applied to the pedals when pedalling without using much energy.
Disadvantages	
Force is applied relatively inefficiently to the pedals. Weight rests exclusively on the buttocks. The spine slumps after a short time for many people (pelvic straightening).	The arms are often stretched through to the high handlebars – this leads to tense shoulders and painful hands. The spine tends to slump quickly due to the "high position".
Fitness level and use	
Low fitness level, occasional cyclists.	Medium fitness level, city cyclists.

Table 103: Overview of sitting positions

6.4.3 Seat post

6.4.3.1 Adjusting the seat post to body weight

Not included in price



Seat posts are components that may be replaced after approval by the vehicle or parts manufacturer. Only seat posts that are approved for use on e-bikes may be used to replace existing ones.

Replacing with different sizes and hardnesses within a product series is permitted for seat posts. Moreover, seat posts may be exchanged if the rearward offset for the series or original range of use is not greater than 20 mm. This is because a change in load distribution outside the intended adjustment range can lead to hazardous steering performance. The seat post length must always be the same when replacing posts.

The correct functioning of the following seat posts depends on the body weight:

- Suspension seat post
- Rhomboid seat post
- Lowerable seat post

If the body weight falls below or exceeds the specifications in Section Maximum permitted total weight (PTW), either the seat post spring or, in the case of integrated seat posts, the complete seat post must be replaced with a seat post from the same product series that is appropriate for the body weight.

The preload in non-damped suspension seat posts must be adjusted in such a way that the suspension seat post does not deflect with just body weight. This prevents the suspension seat post from deflecting and bobbing intermittently at higher pedalling frequencies or if the rider pedals irregularly.

The spring stiffness can be set lower with damped suspension seat posts, thus making use of the negative deflection.

6.4.4 Saddle

6.4.4.1 Replacing the saddle

Not included in price



Saddles are components that may be replaced after approval by the vehicle or parts manufacturer. Replacing different sizes within a product series is permitted for saddles.

Moreover, saddles may be exchanged if the rearward offset to the series or original range of use is not greater than 20 mm since a change in load distribution outside the intended adjustment range can lead to critical steering performance. The saddle shape plays a role here. Only saddles that are approved for use on e-bikes may be used to replace the existing ones.

If the pre-mounted saddle is uncomfortable or causes pain, a saddle optimised to the rider's physique must be used.

- 1 Determining the saddle shape (see Section 6.4.4.2).
- 2 Determining the minimum saddle width (see Section 6.4.4.3).
- 3 Selecting the saddle hardness (see Section 6.4.4.4).

6.4.4.2 Determining the saddle shape

Ladies' saddle

To distribute the pressure optimally over the female bone structure in the seat area, a ladies' saddle should:

- have a relief opening far to the front
- have a wide V-shaped saddle edge.



Figure 88: Example: Ergotec ladies' saddle

Men's saddle

Numbness when pedalling is often caused by high pressure in the sensitive perineal area. If the saddle is adjusted incorrectly, too narrow or too hard, the nose of the saddle presses directly onto the genitals. Blood circulation deteriorates.

The genitals on the outside are seldom the cause of discomfort since they can move out of the way and are not compressed by bone structures.

You should always consult a doctor if you have problems with your prostate. After a prostate operation or inflammation, it is advisable to avoid any pressure in the perineal area and take a longer break from pedelec riding after consulting your doctor. A prostate saddle should then be used. This reduces the pressure in the perineal area by up to 100%.

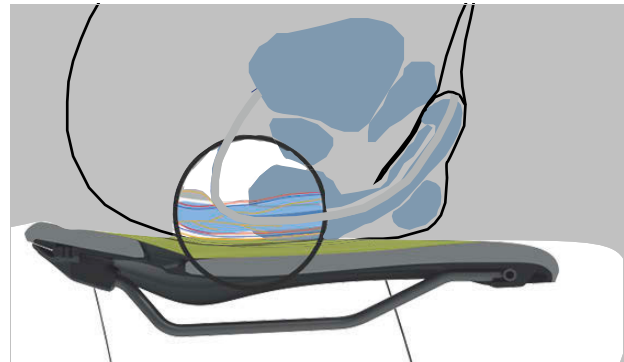

Figure 89: Pressure points on a saddle, male anatomy

To distribute the pressure on the male bone structure in the seat area optimally, the saddle should:

- Shift the pressure to the sitting bones and parts of the pubic arches
- The perineal area must remain as free of pressure as possible



Figure 90: Example: Ergotec men's saddle

6.4.4.3 Determining the minimum saddle width

With corrugated cardboard

- 1 Place corrugated cardboard on a flat, hard, unpadded seat.
- 2 Sit in the middle of the corrugated board.

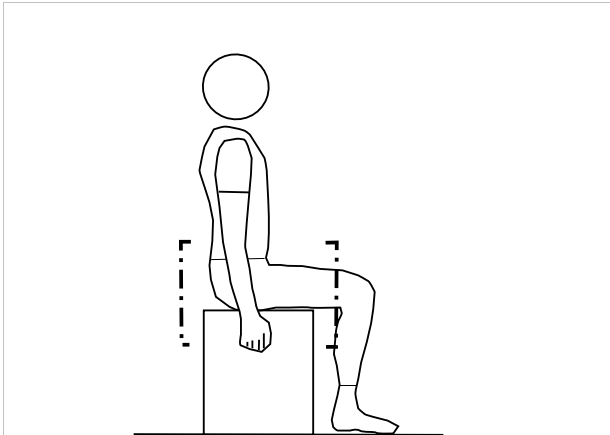

Figure 91: Sitting on the corrugated board

- 3 Pull the seat with your hands and arch your back.
 - ⇒ The sitting bones are more prominent and stand out more clearly on the corrugated cardboard.
- 4 Trace the outer edges of the two depressed areas in a circle.
- 5 Determine the centre of both circles and mark them with a dot.
- 6 Measure the distance between the two centres.

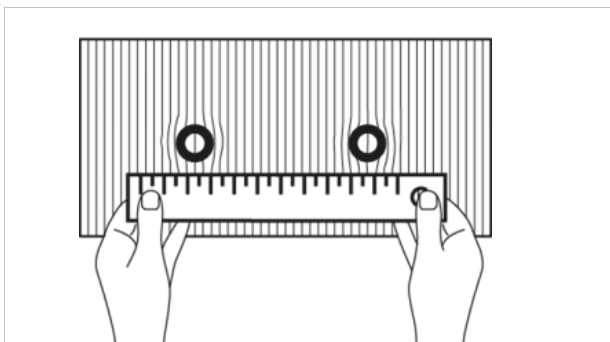

Figure 92: Measuring the distance

- ⇒ The distance between the two centre points is the sit bone distance and corresponds to the minimum saddle width.

- 7 Calculate saddle width (see Section 6.5.4.4).



With a gel cushion

- 1 Smooth gel cushion.
- 2 Place gel cushion on a flat, hard, unpadded seat.
- 3 Sit in the middle of the gel cushion.

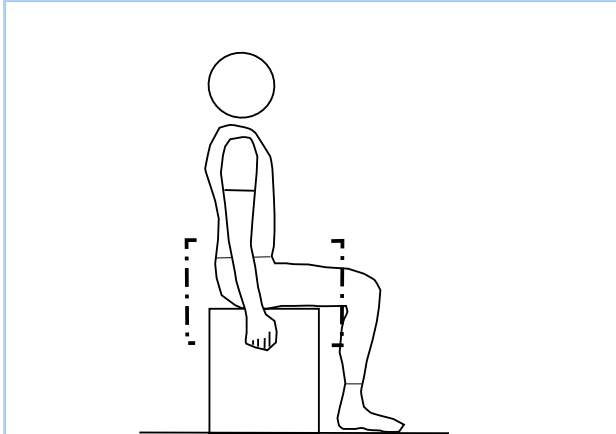

Figure 93: Sitting on the gel cushion

Pull the seat with your hands and arch your back.

- 4 The sitting bones are more prominent and stand out more clearly on the gel cushion.

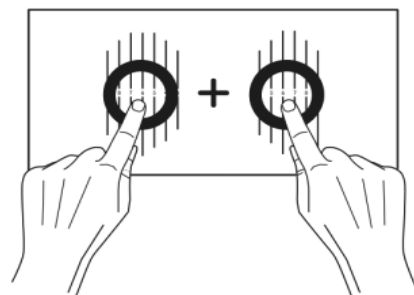

Figure 94: Adding the centres together

- 5 Determine the centres of both sitting bones.
- 6 Add the two values together.
 - ⇒ The total of the values is the sitting bone distance and corresponds to the minimum saddle width.
- 7 Calculate saddle width (see Section 6.5.4.4).

Using calculation

Depending on the position, the following value is added to the minimum saddle width.

Position on roadster	+ 4 cm
Position on city bike	+ 3 cm
Position on trekking bike	+ 2 cm
Position on sports bike	+ 1 cm
Triathlon/time trials	+ 0 cm

Table 104: Calculating the saddle width

6.4.4.4 Selecting the saddle hardness

Saddles are available in a wide range of hardnesses and must be adapted to the pedelec's use:

- A pedelec that is mainly used for commuting in jeans calls for a soft saddle.
- A pedelec that is mainly used for sports riding with padded cycling shorts requires a hard saddle.

If the degree of hardness is not suitable, a new saddle must be selected.

6.4.4.5 Adjusting the saddle hardness

Only applies to pedelecs with this equipment

The hardness of air cushion saddles can be adjusted using the pump valve beneath the seat surface.

Soft	Pump 3 times
Medium	Pump 5 times
Hard	Pump 10 times

Table 105: VELO air cushion saddle settings

6.4.4.6 Straightening the saddle

- ▶ Position saddle in direction of travel. In doing so, align the tip of the saddle with the top tube.

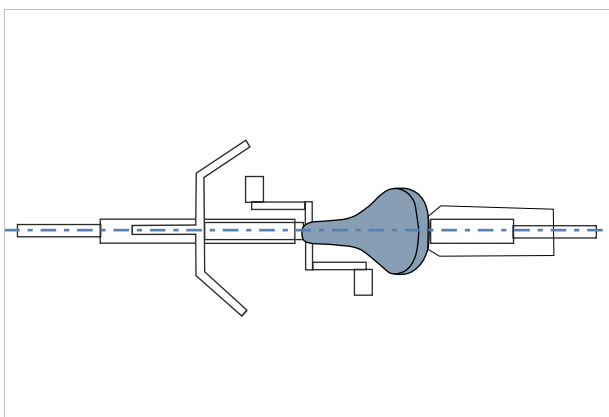

Figure 95: Positioning the saddle in direction of travel

6.4.4.7 Adjusting the saddle height

- ✓ To adjust the saddle height safely, either:
 - Push the pedelec near to a wall so that the pedelec rider can lean on the wall to support themselves or
 - Ask another person to hold the pedelec.
- 1 Use the seat height formula to roughly set the saddle height:

$$\text{Seat height (SH)} = \text{inner leg length (I)} \times 0.9$$
- 2 Climb onto the bicycle.
- 3 Place your heel on the pedal and extend your leg, so that the pedal is at the lowest crank rotation point. Your knee should now be fully extended.

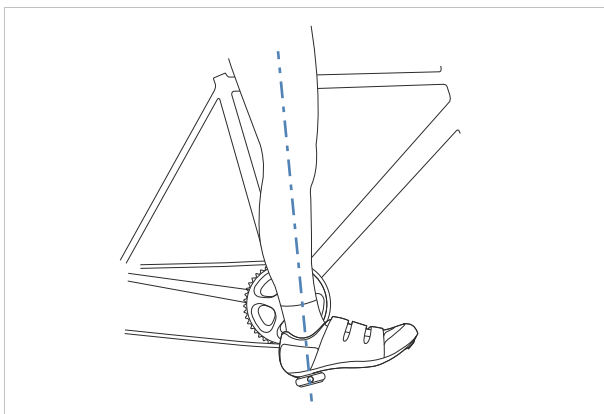

Figure 96: Heel method

- 4 Take a test ride.

- ⇒ Pedelec riders sit straight on the saddle at an optimal saddle height.
 - If the pelvis moves to the left and right as you pedal, the saddle is too high.
 - If your knees are painful after a few kilometres, the saddle is too low.
- ⇒ Position the seat post according to needs if necessary. Adjust the seat height with the quick release.

- 5 Open the quick release on the seat post to change the seat height (1). To do so, push the clamping lever away from the seat post (3).

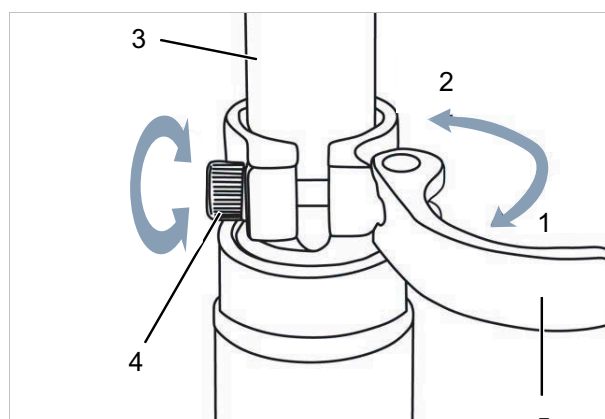

Figure 97: Opening the seat post quick release

- 6 Set the seat post to the required height.

⚠ CAUTION

Crash caused by an excessively high seat post setting

A *seat post* which is set too high will cause the *seat post* or the *frame* to break. This will cause a crash with injuries.

- ▶ Do not pull the seat post out of the frame beyond the minimum insertion depth marking.

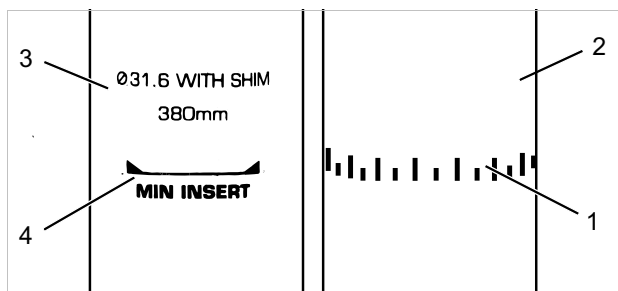

Figure 98: Detailed view of the seat post – examples of the minimum insertion depth marking

- 7 To close it, push the *seat post clamping lever* as far as it will go into the *seat post* (2).
- 8 Check the clamping force of the quick releases.

6.4.4.8 Setting the saddle height with the remote control

Use the seat height formula to set the saddle height:

$$\text{Seat height (SH)} = \text{inner leg length (l)} \times 0.9$$

- 1 [Lowering the saddle](#) (see Section 6.14.1).
- 2 [Raising the saddle](#) (see Section 6.14.2).

Notice

- ▶ If you are unable to achieve the required saddle height, lower the seat post further into the seat tube. The seat post Bowden cable must be tightened in the frame up to the remote control to the same length as the seat post was lowered.
- ▶ If this is not possible, contact your specialist dealer.

6.4.4.9 Adjusting the saddle position

The saddle can be shifted on the saddle frame. The right horizontal position ensures an optimal leverage position for legs. This prevents knee pain and painful incorrect pelvis positions. If you have displaced the saddle more than 10 mm, you need to adjust the saddle height again since both settings affect one another.

- ✓ The saddle setting must only be made when the bicycle is stationary.
- ✓ To set the saddle position, either:
 - Push the pedelec near to a wall so that the pedelec rider can lean on the wall to support themselves or
 - Ask another person to hold the pedelec.
- ✓ Move the saddle within its permitted displacement range only (marked on the saddle stay).

- 1 Climb onto the pedelec.
- 2 Place the pedals into the vertical position with your feet.
 - ⇒ Pedelec riders are adopting the optimal saddle position if the perpendicular line from the kneecap runs through the pedal axle.
 - ▶ If the perpendicular line crosses behind the pedal, bring the saddle further forward.
 - ▶ If the perpendicular line crosses in front of the pedal, bring the saddle further back.

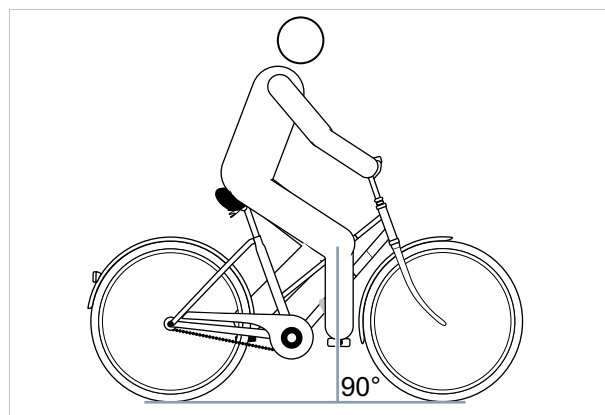

Figure 99: Knee cap perpendicular line

- 3 Unfasten and adjust the designated screw connections, and clamp them with the maximum tightening torque for the saddle clamping screws.

6.4.4.10 Adjusting the saddle tilt

The saddle tilt must be adjusted to the seat height, the saddle and handlebar position, and the saddle shape to ensure an optimum fit. The seating position can be optimised in this way if needed.

The saddle prevents pedelec riders from slipping backwards or forwards when placed in a horizontal position. This prevents seat problems. In any other position, the tip of the saddle may press uncomfortably into the crotch area. It is also recommended that the centre of the saddle is exactly straight. This ensures that the rider is seated with their sit bones on the wide rear part of the saddle.

- 1 Adjust the saddle tilt to horizontal.
- 2 Position saddle middle so that it is completely straight.

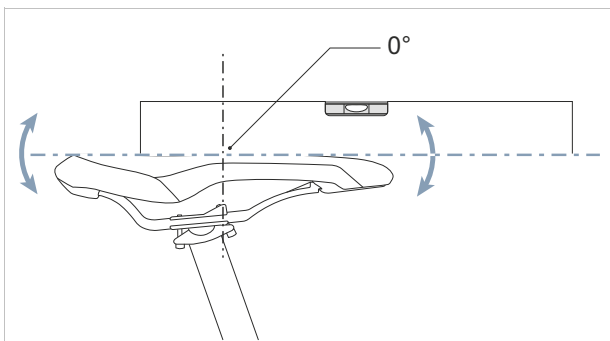

Figure 100: Horizontal saddle tilt with 0° tilt in the centre of the saddle

- ⇒ Pedelec riders sit comfortably on the saddle and do not slip backwards or forwards.
- 3 Pedelec riders tend to slip forwards on the narrow part of the saddle, adjust the saddle again to position (see Section [6.4.4.9](#)) or tilt the saddle very slightly backwards.

6.4.4.11 Checking the saddle

- Check the saddle after adjustment (see Section [7.5.7](#)).

6.4.5 Handlebars

6.4.5.1 Replacing the handlebars

Not included in price



Handlebars are components that may be replaced after approval by the vehicle or parts manufacturer. Only handlebars that are approved for use on e-bikes may be used to replace the existing ones. Handlebars may be replaced if the cable and/or line lengths do not need to be changed. A change in riding position is allowed within the original cable length. Furthermore, the load distribution on the pedelec changes considerably and may potentially lead to hazardous steering performance.

- ▶ Check handlebar width and hand position.
- ▶ Have handlebars replaced at the specialist dealer's if necessary.

6.4.5.2 Adjusting the handlebar width

The handlebar width should be as wide as the rider's shoulders as a minimum. This is measured from mid-point to mid-point on the hand contact surfaces.

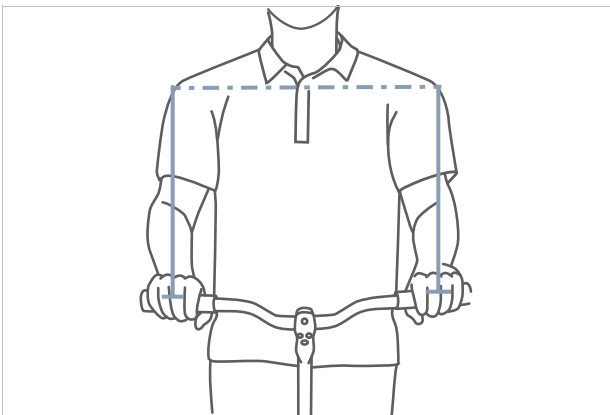

Figure 101: Determining the optimal handlebar width

The wider the handlebars are, the more control they provide, although wide handlebars require greater supporting force. Wider handlebars are particularly useful to ensure a safer ride for loaded touring bikes.

6.4.5.3 Adjusting the hand position

The hand is in an optimal position on the handlebars when the forearm and hand are in a straight line, i.e. the wrist is not bent. In this way, the nerves are not pinched and do not cause pain.

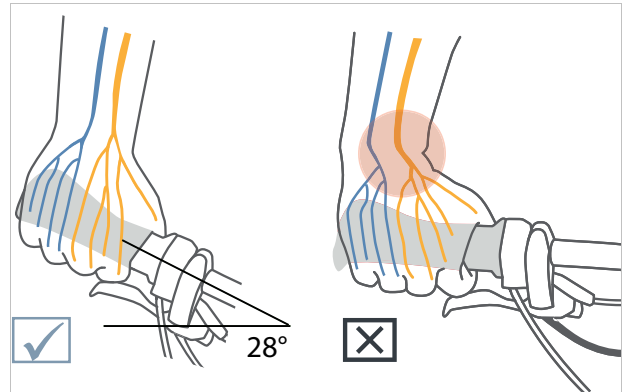

Figure 102: Distribution of nerves with curved and straight handlebars

The narrower the shoulders are, the greater the bend of the handlebars should be (maximum 28°).

Straight handlebars are advisable for sports bikes (e.g. MTB). They support direct steering behaviour, but lead to peaks in pressure and greater muscular strain on the arm and shoulder muscles.

6.4.5.4 Adjusting the handlebars

The handlebars and their position determine the posture that the pedelec rider adopts on the pedelec.

- 1 After selecting the seating position (see Section 6.5.2), determine the angle of the upper body and the upper arm.
- 2 Tension the back muscles when adjusting the handlebars. The only way to stabilise the spine and protect it from excessive strain is to tension the back and abdominal muscles. Passive muscles are not able to perform this important task.
- 3 Set the required handlebar position by adjusting height and angle (see Section 6.4.6).
- 4 After adjusting the handlebars, check the saddle height and riding position again. The position of the pelvis on the saddle may have changed when the handlebars were adjusted. This can have considerable impact on the position of the hip joint due to the pelvis tilting and may change the usable leg length on the saddle support by up to 3 cm.
- 5 Correct the saddle height and position if necessary (see Section 6.5.4.8 and 6.5.4.11).

6.4.6 Stem

6.4.6.1 Replacing the stem

Not included in price



Handlebar-stem units are components that may be replaced after approval by the vehicle or parts manufacturer.

Only units that are approved for use on e-bikes may be used to replace the existing ones. A stem must be replaced if cable and/or line lengths do not need to be changed.

A change in riding position is allowed within the original cable length. Furthermore, the load distribution on the pedelec changes considerably and may potentially lead to hazardous steering performance.

6.4.6.2 Adjusting the handlebar height with quick release

Only applies to pedelecs with this equipment

- 1 Open the stem clamping lever.

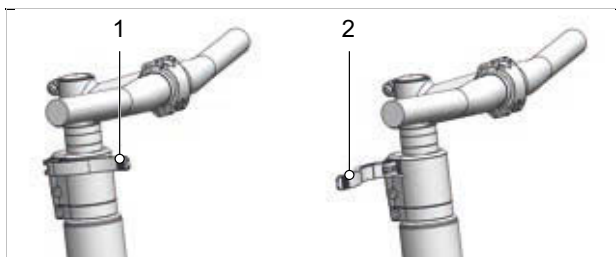

Figure 103: Open (2) and closed (1) stem clamping lever; All Up used as an example

- 2 Pull out the handlebars to the required height. Observe minimum insertion depth.

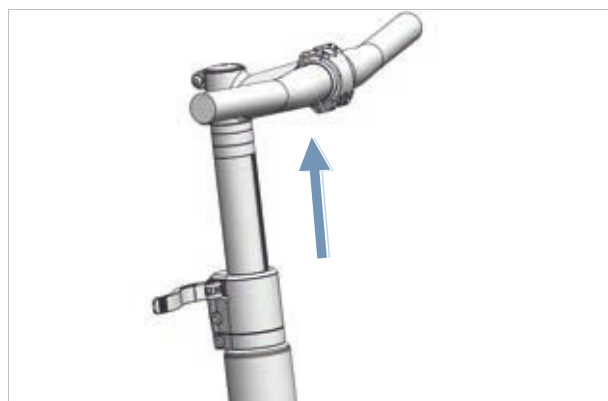

Figure 104: Pulling the handlebars upwards; All Up used as an example

- 3 Close the stem clamping lever.

6.4.6.3 Checking the stem stability

- ▶ Hold handlebars firmly after adjusting the saddle. Press full body weight on the handlebars.
- ⇒ The handlebars remain stable in their position.

6.4.6.4 Adjusting the quick release clamping force



Crash caused by incorrectly set clamping force

Applying excessive clamping force damages the quick release. Insufficient clamping force will result in unfavourable transmission of force. This can cause components to break. This will cause a crash with injuries.

- ▶ Never fasten a quick release using a tool (e.g. hammer or pliers).

If the *handlebar clamping lever* stops before reaching its end position, unscrew the *knurled nut*.

- ▶ Tighten the *knurled nut* on the seat post if the *seat post clamping lever's* clamping force is not effective enough.
- ▶ Contact your specialist dealer if the clamping force cannot be set.

6.4.6.5 Setting the quill stem

Only applies to pedelecs with this equipment

In the case of a quill stem, the stem and fork steerer form a permanently interconnected component, which is clamped in the fork steerer. The stem and shaft must be replaced together.

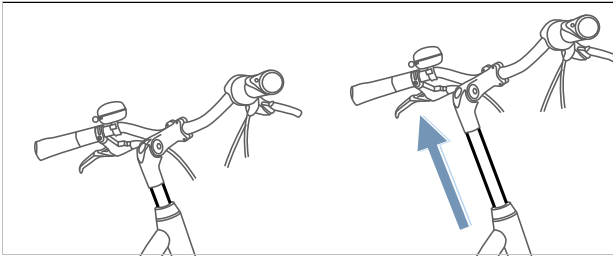

Figure 105: Adjusting the quill stem height

- 1 Undo screw.
- 2 Pull quill stem out.
- 3 Tighten screw.

Only applies to pedelecs with this equipment

Angle-adjustable stems are available in different lengths for quill and Ahead stems.

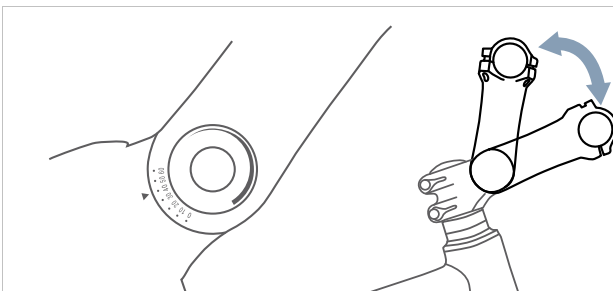

Figure 107: Different versions of angle-adjustable stems

Adjusting the stem angle (c) changes both the distance from the upper body to the handlebars (b) and the handlebar height (a).

6.4.6.6 Adjusting the Ahead stem

Only applies to pedelecs with this equipment

In the case of an Ahead stem, the stem is placed directly on the fork steerer, which protrudes over the frame.

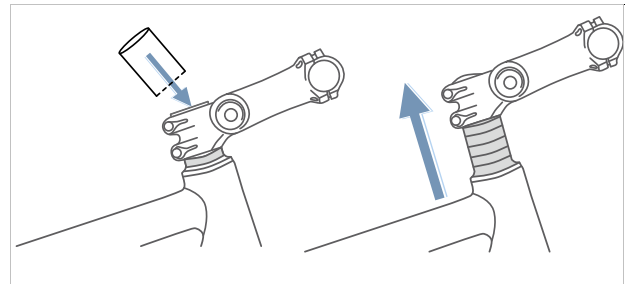

Figure 106: Raising the Ahead stem by fitting spacer rings

The handlebar height is adjusted once during production using spacer rings. The part of the fork steerer protruding is then cut off. The handlebar stem can then no longer be set higher, but only slightly lower.



Figure 108: City bike (blue) and trekking bike position (red) by changing the angle

6.4.6.8 Checking the stem

- Check saddle stem after adjusting it (see Section [7.5.5](#)).

6.4.7 Handles

6.4.7.1 Replacing the handles

Not included in price



Handles with bolt clamps are components which may be replaced without approval. Only handles that are approved for use on e-bikes may be used to replace the existing ones.

If there is pain or numbness in the index, middle finger or thumb, this may be due to excessive pressure on the exit of the carpal tunnel. On longer rides, this can increasingly cause hand fatigue and make it more and more difficult to maintain a correct hand position.

In the case of ergonomically shaped handles, the palm rests on the anatomically shaped handle. A greater contact surface means that the pressure is more evenly distributed. Nerves and vessels are no longer squeezed in the carpal tunnel.

Moreover, the hand is supported and held in the correct position so that the hand can no longer bend.

If the pre-mounted handles are uncomfortable or cause pain or numbness in the index, middle finger or thumb, ergonomic handles, bar ends or multi-position handlebars should be used.

6.4.7.2 Adjusting ergonomic handles

Only applies to pedelecs with this equipment

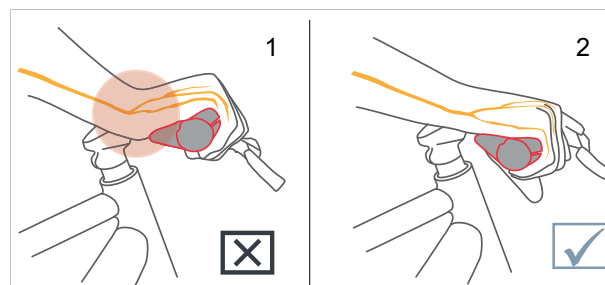

Figure 109: Incorrect (1) and correct (2) position of the handle



- 1 Undo handle clamping screw.
 - 2 Turn handle into the right position.
 - 3 Fasten handle clamping screw with the torque value indicated there.
- ⇒ The handles are firmly fastened.
- ⇒ The pull-off force of the handles is at least 100 N in the roadster, city and trekking positions, and at least 200 N in the sporty position.

6.4.7.3 Checking the handles

- ▶ Check handlebars after adjusting the handles (see Section [7.5.6](#)).

6.4.8 Tyres

6.4.8.1 Replacing tyres

Not included in price



Different tyres need to be used when the area of use is changed, more weight or greater puncture protection is added, and greater acceleration or more dynamic cornering is used.

Tyres are may only be replaced after approval by the vehicle or parts manufacturer.

Tyres may be replaced if

- They are approved for use on e-bikes
- They comply with ETRTO dimensions
- They have the same load capacity as a minimum
- They have a comparable level of puncture protection as a minimum

6.4.8.2 Adjust tyre pressure

The correct tyre pressure largely depends on the weight load on the tyres. This load is determined by the pedelec’s tare weight, the rider’s body weight and the luggage load.

Unlike cars, the weight of the vehicle has little impact on the total weight. Moreover, the personal preferences for low rolling resistance or a high degree of suspension comfort vary a great deal.

It is important to remember that

- the higher the tyre pressure is, the lower the wear, rolling resistance and the risk of breakdown are.
- the lower the pressure in the tyre is, the greater the comfort and grip that the tyre offers is.

In the case of pedelecs used on the road, the rule is the greater the tyre pressure is, the lower the tyre rolling resistance is. The risk of breakdown is also lower when the pressure is high. A permanently excessively low tyre pressure often leads to premature wear in the tyre. Cracking in the side wall is a typical consequence of very low tyre pressure. Abrasion is also unnecessarily high.

On the other hand, a tyre can absorb road impacts more effectively at a low pressure.

As a general rule, wide tyres are operated at a lower tyre pressure. They provide the option of exploiting the advantages of the lower tyre pressure without the serious disadvantages it causes with regard to wear, rolling resistance and breakdown protection.

- ✓ Never exceed or go below the minimum and maximum pressure limits indicated on the tyre.

1 Pump the tyre to the recommend tyre pressure.

Tyre width	Tyre pressure in bar for body weight		
	approx. 60 kg	approx. 80 kg	approx. 110 kg
25 mm	6.0	7.0	8.0
28 mm	5.5	6.5	7.5
32 mm	4.5	5.5	6.5
37 mm	4.0	5.0	6.0
40 mm	3.5	4.5	6.0
47 mm	3.0	4.0	5.0
50 mm	2.5	4.0	5.0
55 mm	2.0	3.0	4.0
60 mm	2.0	3.0	4.0

Table 106: SCHWALBE recommend tyre pressure

2 Perform a visual check on tyres.



Figure 110: Correct tyre pressure. The tyre is barely deformed under the load of the body weight



Figure 111: Far too little tyre pressure

6.4.9 Brake

The handbrake grip distance can be adjusted to ensure that it can be reached more easily. The pressure point can also be adjusted to the pedelec rider's preferences.

6.4.9.1 Replacing brakes

Not included in price



The braking system components may only be replaced with original components.

In the case of disc brake linings, the lining compound may be adapted to the surface and the rider's experience.

6.4.9.2 Retracting the brake linings

Disc brakes require wearing-in time. The braking force increases over time. The braking force is increased during break-in time. This is also the case when the brake pads or brake discs are replaced.

- 1 Accelerate pedelec to 25 km/h.
 - 2 Brake pedelec until it comes to a halt.
 - 3 Repeat process 30 to 50 times.
- ⇒ The disc brake is retracted and provides optimal braking power.

6.4.9.3 Changing the handbrake position

Having the handbrake in the correct position prevents the rider from stretching their wrist too far. Moreover, the brake can also be operated without any discomfort and without changing the handle position or releasing the handle.

- ✓ Apply handbrake with the third finger phalanx in bursts to brake gently.
 - ✓ The setting for the middle finger is used for pedelec riders who brake with their middle finger or with two fingers.
- 1 Position your hand on the handle in such a way that the outer heel of the hand is flush with the end of the handlebar.
 - 2 Extend the index finger (about 15°).

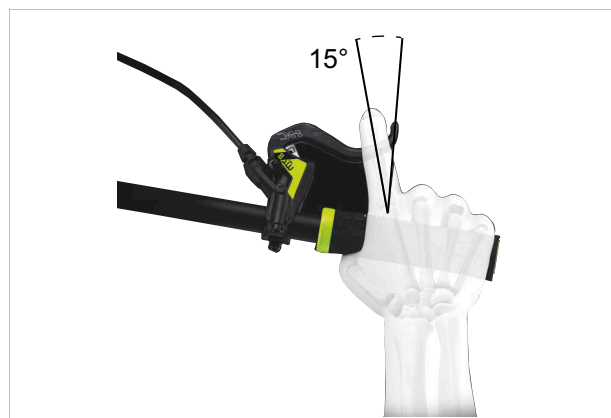

Figure 112: Handbrake position

- 3 Push handbrake outwards until the third finger phalanx sits in the recessed grip.

6.4.9.4 Changing the handbrake inclination angle

The nerves that pass through the carpal tunnel are connected to the thumb and the index and middle fingers. An excessively steep or excessively flat brake angle will cause the wrist to bend, thus narrowing the carpal tunnel. This can cause numbness and tingling in the thumb and index and middle fingers.

- 1 Calculate the difference between the height of the handlebars and the saddle height to determine the saddle-handlebar height difference.

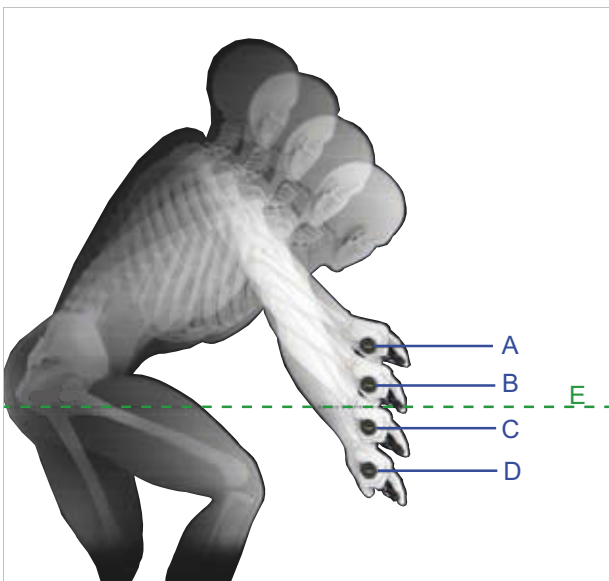

Figure 113: Example of 4 different handlebar heights (A, B, C and D) and the saddle height (E)

Calculation	Saddle-handlebar height difference [mm]
A – E	>10
B – E	0... +10
C – E	0... -10
D – E	< -10

Table 107: Examples of saddle-handlebar height difference

Adjust the angle of the handbrake so that it forms a natural extension of the forearm.

- 2 Set the brake lever angle as indicated in the table.

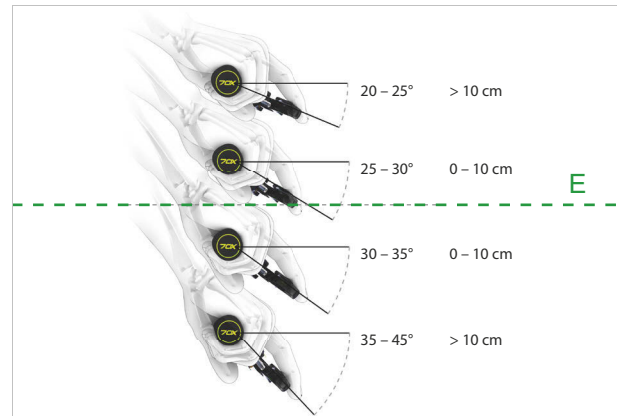

Saddle-handlebar height difference (mm)	Brake angle
>10	20°...25°
0... 10	25°...30°
0... -10	30°...35°
< -10	35°...45°

Figure 114: Brake angle

6.4.9.5 Determining the grip distance

- 1 Measure hand size using the grip distance gauge.
- 2 Adjust the grip distance at the pressure point based on the hand size.



Figure 115: Handbrake positioning

Hand size	Grip distance (cm)
S	2
M	3
L	4

6.4.9.6 MAGURA handbrake pressure point

Only applies to pedelecs with this equipment

WARNING

Brake failure due to incorrect setting

If the pressure point is set with brakes where the brake linings and brake disc have reached their wear limit, the brakes may fail and cause an accident with injury.

- ▶ Before you adjust the pressure point, ensure that the brake linings and brake disc have not reached their wear limit.

The pressure point setting is adjusted using the twist knob.

- ▶ Turn the twist knob towards the plus (+) symbol.
 - ⇒ The handbrake moves closer to the handlebars.
 - ⇒ The lever pressure point activates sooner.
- ▶ Re-adjust the grip distance as necessary.
- ▶ Turn the twist knob towards the minus (-).
 - ⇒ The brake lever moves further away from the handlebars.
 - ⇒ The lever pressure point activates later.
- ▶ Re-adjust the grip distance as necessary.

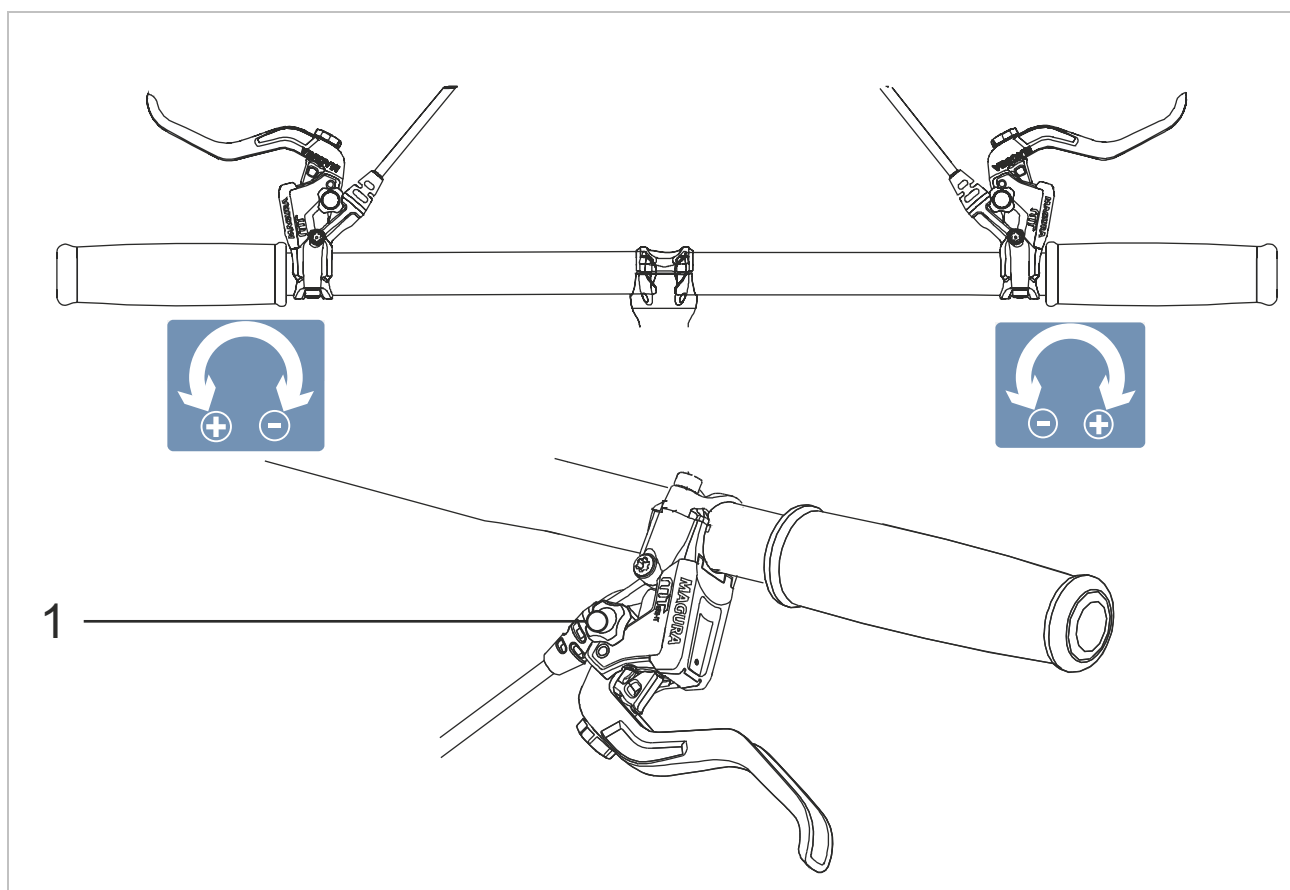

Figure 116: Using the twist knob (1) to adjust the pressure point

6.4.9.7 Setting the grip distance for a MAGURA handbrake disc brake

Only applies to pedelecs with this equipment

⚠ WARNING

Crash caused by incorrectly set grip distance

If brake cylinders are set incorrectly or installed wrongly, the braking power may be lost at any time. This may cause a crash with injuries.

- ▶ Ensure that the fully applied handbrake is at a minimum distance of 20 mm from the handlebars.

The handbrake position can be adjusted to the rider's requirements. Such adjustment does not affect the pressure point or the position of the brake linings.

- ▶ Turn the setting screw/twist knob (5) anti-clockwise towards minus (-).
 - ⇒ The handbrake will move closer to the handlebar grip.
- ▶ Turn the setting screw/twist knob (5) clockwise towards plus (+).
 - ⇒ The handbrake will move away from the handlebar grip.

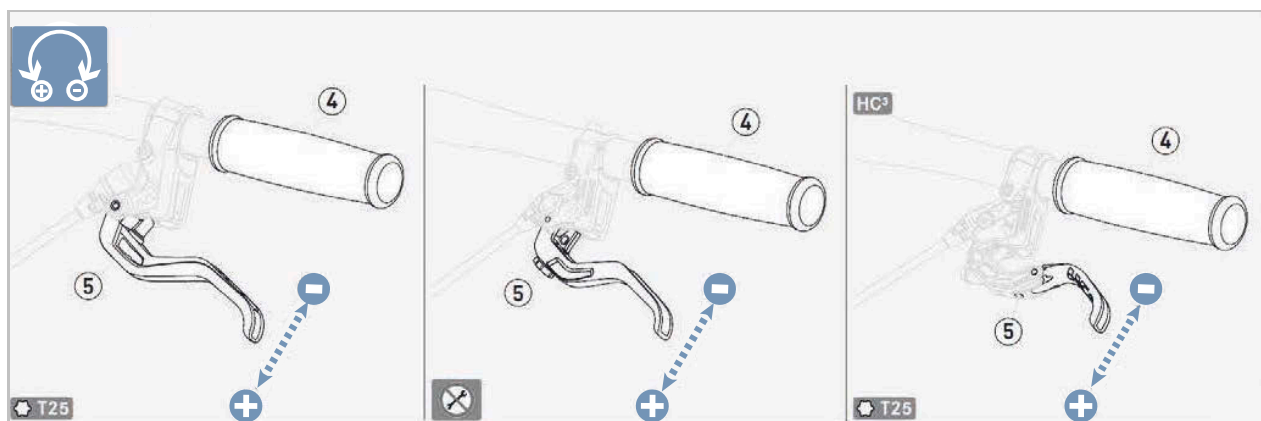

Figure 117: Adjusting the grip distance for a MAGURA handbrake disc brake

6.4.10 Control panel and gear shift

The control panel and gear shift must be adjusted to the rider's needs.

- 1 Undo attachment screw.
- 2 Place control panel or gear shift into the position where the rider can use the control panel or the shifter with their thumb and/or index finger.
- 3 Fasten attachment screw into position with a 4 mm hex bit with 3 Nm.

6.4.10.1 SHIMANO shifter

Only applies to vehicles with this equipment

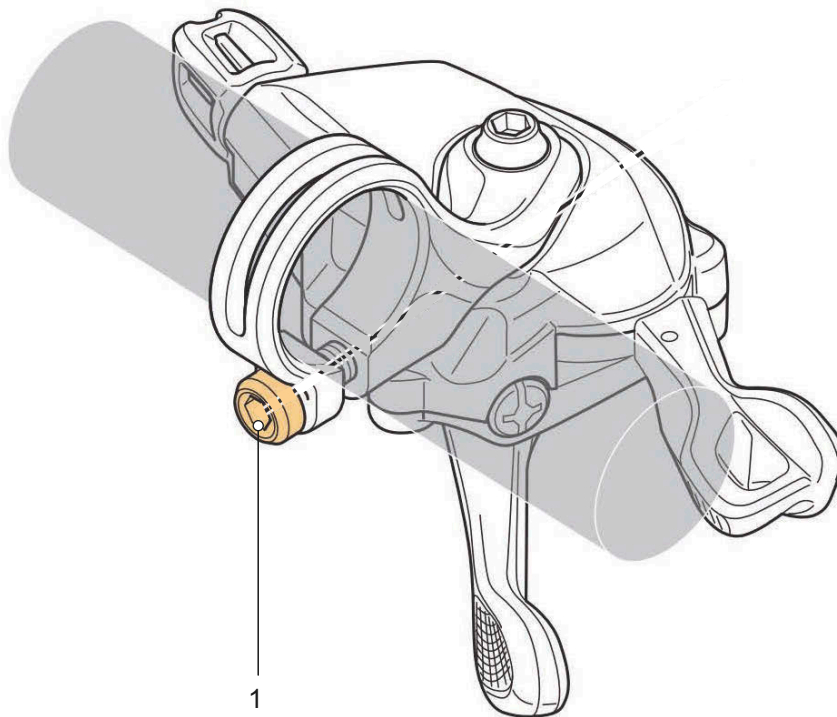

Figure 118: Position of attachment screw (1)

6.4.11 Suspension and damping

Suspension and damping can be adjusted to the rider's weight in up to six increments, depending on the suspension system.

► Follow the correct order for adjustment.

Sequence	Adjustment	Section	For pedelecs with components only	
			Suspension fork	Rear frame damper
1	Adjusting the suspension fork sag	6.4.12	x	
2	Adjusting the rear frame damper sag	6.4.13		x
3	Adjusting the suspension fork rebound damper	6.4.14	x	
4	Adjusting the rear frame damper rebound damper	6.4.15		x
5	Before each ride:			
	Adjust the rear frame damper compression damper	6.16.3		x
6	While riding:			
	Adjusting the suspension fork	6.21	x	

Table 108: Correct order for suspension and damping adjustment

6.4.12 Adjusting the suspension fork sag



Crash caused by incorrectly set suspension

If the suspension is set incorrectly, the suspension fork may become damaged, meaning problems may occur when steering. This will cause a crash with injuries.

- Never ride without air in air suspension forks.
- Never use the pedelec without adjusting the suspension fork to the body weight.

Adjustments on the chassis change ride performance significantly. The rider needs to get used to the pedelec and break it in to prevent accidents.

The sag depends on the position and body weight and should be set based on preferences and on how the pedelec is used.

Greater sag

A greater sag increases sensitivity to bumps, thus producing greater suspension motion. A greater sensitivity to bumps ensures more comfortable ride performance and is used on pedelecs with longer deflection.

Decreased sag

A decreased sag reduces sensitivity to bumps, thus producing less suspension motion. A lower sensitivity to bumps ensures a firmer, more efficient ride performance and is generally used on pedelecs with shorter deflections. The adjustment shown here represents a default setting. The default settings should change, adapted to suit the surface and preferences.

It is advisable to make a note of the default settings. These can then be used as a starting point for subsequent optimised settings and as a safeguard against unintentional changes.

6.4.12.1 Adjusting the sag for the SR SUNTOUR steel suspension fork

Only applies to pedelecs with this equipment

You can pre-tension the steel suspension to adjust to the rider's weight and their preferred

riding style. It is not the coil spring hardness which is adjusted; it is its preload.

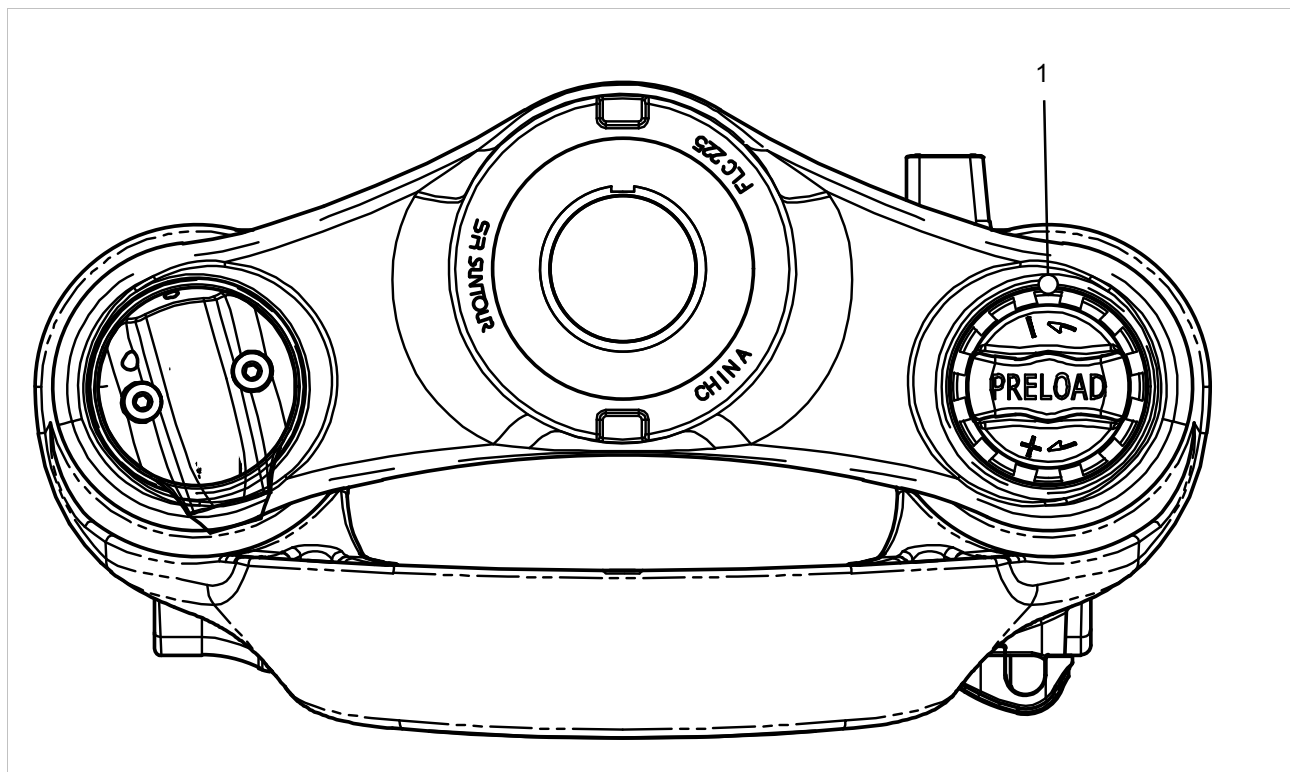

Figure 119: Example with SR SUNTOUR, sag setting wheel on the fork crown

- 1 Put on normal cycling clothing (including baggage).
- 2 Turn the **sag setting wheel** (see Section 3.5.4.1) until the required sag is reached.
 - ▶ Turn the **sag setting wheel** clockwise.
 - ⇒ The spring preload is increased.
 - ▶ Turn the **sag setting wheel** anticlockwise.
 - ⇒ The spring preload is reduced.
- 3 If you are unable to achieve the required degree of hardness, contact your specialist dealer.

6.4.13 Adjusting the rear frame damper sag

CAUTION

Crash caused by broken rear frame damper

If the rear frame damper's maximum air pressure is exceeded, this can cause the rear frame damper to break. This can result in loss of control and a crash with cut injuries or even death.

- ▶ Never exceed the indicated maximum air pressure when adjusting the sag.

Adjustments on the chassis change ride performance significantly. The rider needs to get used to the pedelec and break it in to prevent accidents.

The adjustment shown here represents a default setting. The rider should change the default setting to suit the surface and their preferences.

It is advisable to make a note of the default settings. These can then be used as a starting point for subsequent optimised settings and as a safeguard against unintentional changes.

Negative deflection (sag)

The sag is the percentage of total spring deflection that is compressed by the rider's body weight, including equipment (such as a backpack), their seating position and frame geometry. Sag is not caused by riding.

Greater sag

A greater sag increases sensitivity to bumps, thus producing greater suspension motion. A greater sensitivity to bumps ensures more comfortable ride performance and is used on pedelecs with a longer deflection.

Decreased sag

A decreased sag reduces sensitivity to bumps, thus producing less suspension motion. A lower sensitivity to bumps ensures a firmer, more efficient ride performance and is generally used on pedelecs with a shorter deflection.

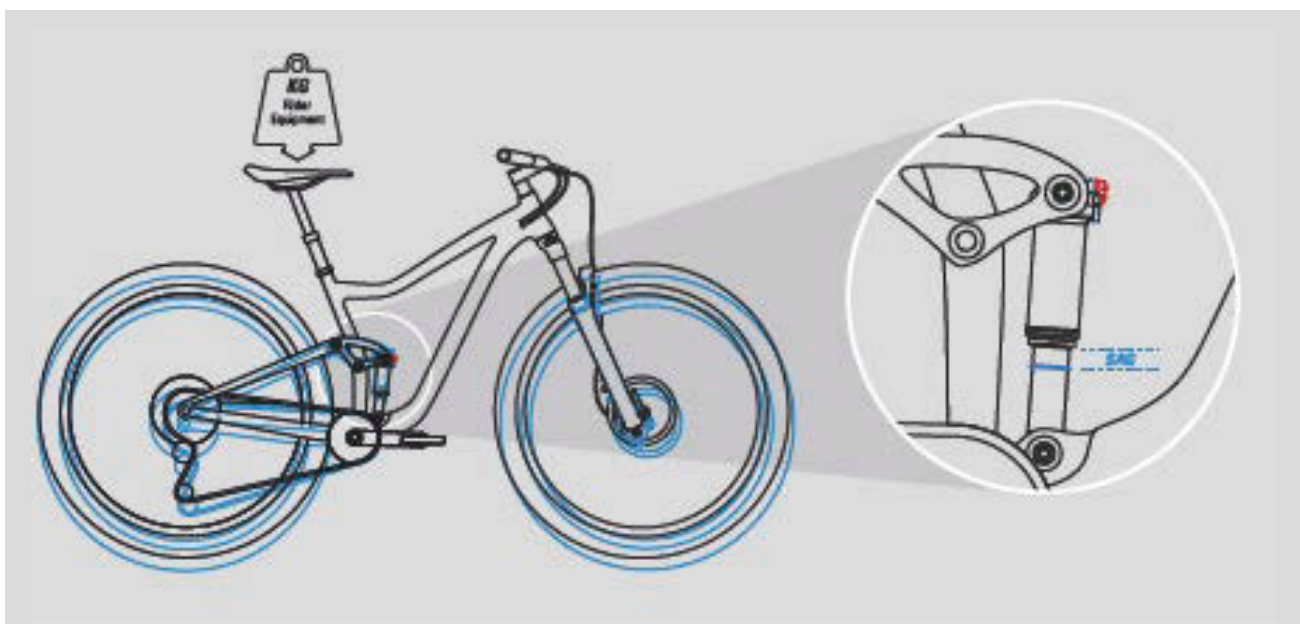

Figure 120: SAG rear frame damper

When optimally adjusted, the rear frame damper deflects quickly and unhindered when the bike hits bumps and absorbs a bump. The traction is maintained.

6.4.13.1 Adjusting the RockShox rear frame damper sag

Only applies to pedelecs with this equipment

- ✓ Adjusting the suspension fork sag (see Section 6.4.12).
- ✓ When adjusting the sag, ensure that all dampers are in the open position, i.e. turned anti-clockwise until they stop.

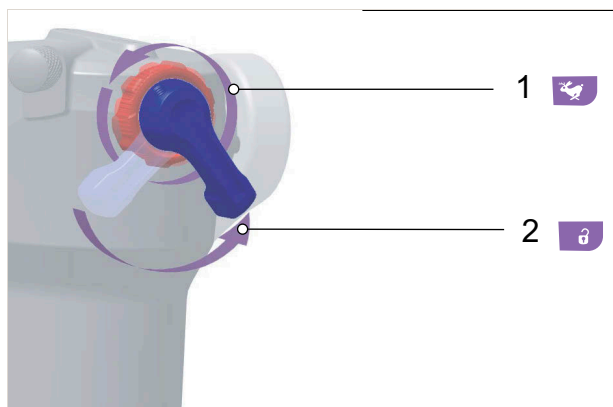

Figure 121: Opening the rebound damper (1) and compression adjuster (2)

- 1 Release air completely from rear frame damper.
- 2 Pressurise the air spring chamber to 100 PSI (6.9 bar) with a high-pressure damper pump.
- 3 Detach high-pressure damper pump.
- 4 Fully deflect rear frame damper five times to compensate the positive and negative air suspension.
- 5 Use a high-pressure damper pump to fill the rear frame damper to the pressure corresponding to the total weight of the person riding, including clothing and baggage.

Notice

If the air pressure in the rear frame damper is exceeded or undershot, the damper can be permanently damaged. The details are on the rear frame damper.

Weight		Air pressure	
Kilogram	Pound (lbs)	Pound per square inch	bar
55	121	121	8.3
60	132	132	9.1
65	143	143	9.9
70	154	154	10.6
75	165	165	11.4
80	176	176	12.1
85	187	187	12.9
90	198	198	13.7
95	209	209	14.4
100	220	220	15.7
110	242	242	16.7

Table 109: Filling pressure table for ROCKSHOX rear frame dampers

- 6 Deflect rear frame damper to compensate the air pressure.
- 7 Put on normal cycling clothing (including baggage).
- 8 Ask someone to hold the pedelec. Stand on the pedals.
- 9 Deflect rear frame damper fully gently two or three times.
- 10 Ask your helper to push the **O-ring** against the wiper seal.



Figure 122: Moving the O-ring on the rear frame damper

11 Read the sag value on the scale.

The optimum sag percentage is 25%. The sag level may be adjusted by $\pm 5\%$, depending on the rider's preferences (20% to 30%).

12 The air pressure must be adjusted if the sag level is not reached.

- ▶ Increase the air pressure to reduce the sag.
- ▶ Decrease the air pressure to increase the sag.

6.4.14 Adjusting the suspension fork rebound damper

Only applies to pedelecs with this equipment

Rebound damping is adjusted to the rider's body weight, spring stiffness, deflection, the terrain and the pedelec rider's preferences.

If the air pressure or spring stiffness increases, the extension and rebound speeds also increase. Rebound damping needs to be increased to achieve an optimal setting if the air pressure or spring stiffness is increased.

6.4.14.1 Adjusting the SR Suntour rebound damper suspension fork

Only applies to pedelecs with this equipment

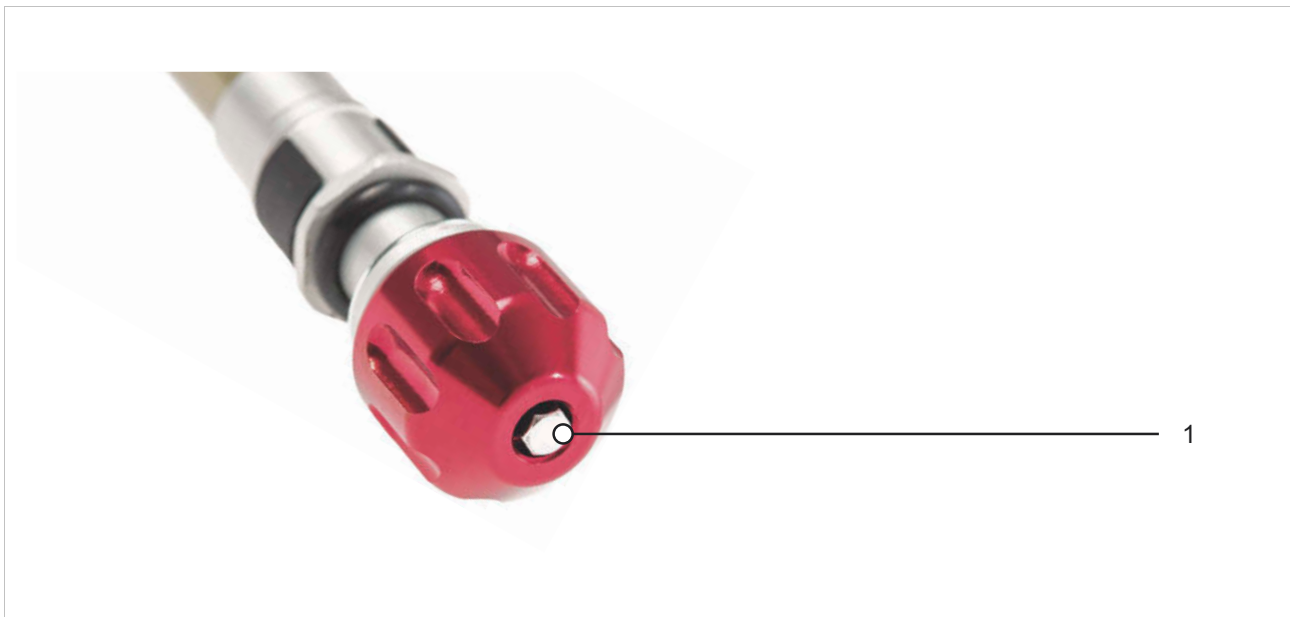

Figure 123: Example of SR SUNTOUR rebound adjuster (suspension fork) (1)

- ✓ Adjusting the suspension fork sag (see Section 6.4.12).
- 1** Turn the rebound adjuster (suspension fork) clockwise to the closed position until it stops.
- 2** Turn **rebound adjuster (suspension fork)** gently anti-clockwise.
- ⇒ Adjust the rebound damper in such a way that the suspension fork rebounds quickly but without bottoming out upward. Bottoming out refers to occasions when the suspension fork rebounds too quickly and stops moving abruptly once it has reached the full rebound distance. You can hear and feel a slight impact when this happens.

6.4.15 Adjusting the rear frame damper rebound damper

Only applies to pedelecs with this equipment

Adjust the rebound damper so that the rear frame damper rebounds quickly but without bottoming out upwards. Bottoming out refers to occasions when the rear frame damper rebounds too quickly and stops moving abruptly once it has reached the full rebound distance. You can hear and feel a slight impact when this happens.

Adjusting high-speed and low-speed rebound dampers on the rear frame damper

Only applies to pedelecs with this equipment

Adjustment of the high-speed rebound (HSR) is advantageous for enabling the rear frame damper to quickly recover from heavier impacts and impacts on right-angled obstacles in order to absorb successive impacts.

Adjustment of the low-speed rebound (LSR) is advantageous for enabling control of the suspension behaviour of the damper when brake pitching, during technically demanding climbs and when riding at an angle when additional traction is required.

6.4.15.1 Adjusting the ROCKSHOX rear frame damper rebound damper

Only applies to pedelecs with this equipment

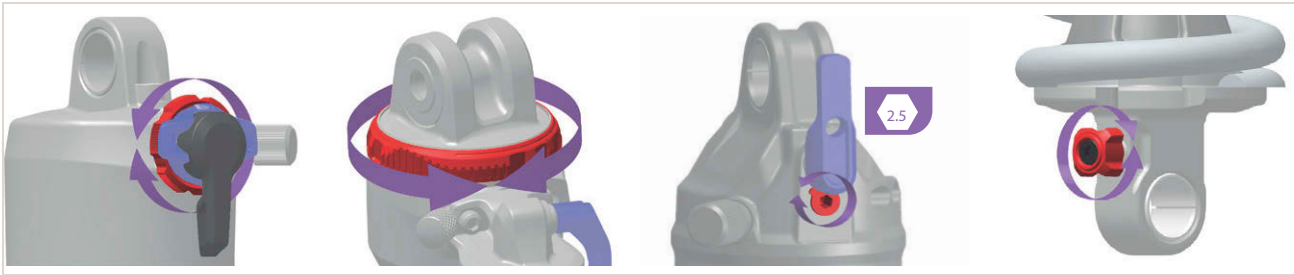

Figure 124: The position and shape of the rebound adjuster (rear frame damper) depends on the model. Rebound adjusters are always red

- ✓ Adjusting the rear frame damper sag (see Section 6.4.13).
- ▶ Turn **rebound adjuster (rear frame damper)** clockwise.
 - ⇒ The rebound damping is increased.
- ▶ Turn **rebound adjuster (rear frame damper)** anti-clockwise.
 - ⇒ The rebound damping is reduced.

6.4.16 Riding light

6.4.16.1 Replacing the headlight

Not included in price



Headlights may only be replaced after approval by the manufacturer or system provider.

6.4.16.2 Replacing the rear light and (spoke) reflector

Not included in price



The rear light and (spoke) reflector may be replaced without special approval provided they comply with the laws of the country where the pedelec will be ridden.

6.4.16.3 Setting the riding light

Example 1

If the headlight is positioned too high, oncoming traffic will be dazzled. This can cause a serious accident with fatalities.

Example 2

Positioning the headlight correctly can ensure that oncoming traffic is not dazzled and no-one is put at risk.

Example 3

If the headlight is positioned too low, the space ahead is not illuminated to an optimum extent and the rider's vision is reduced in the dark.

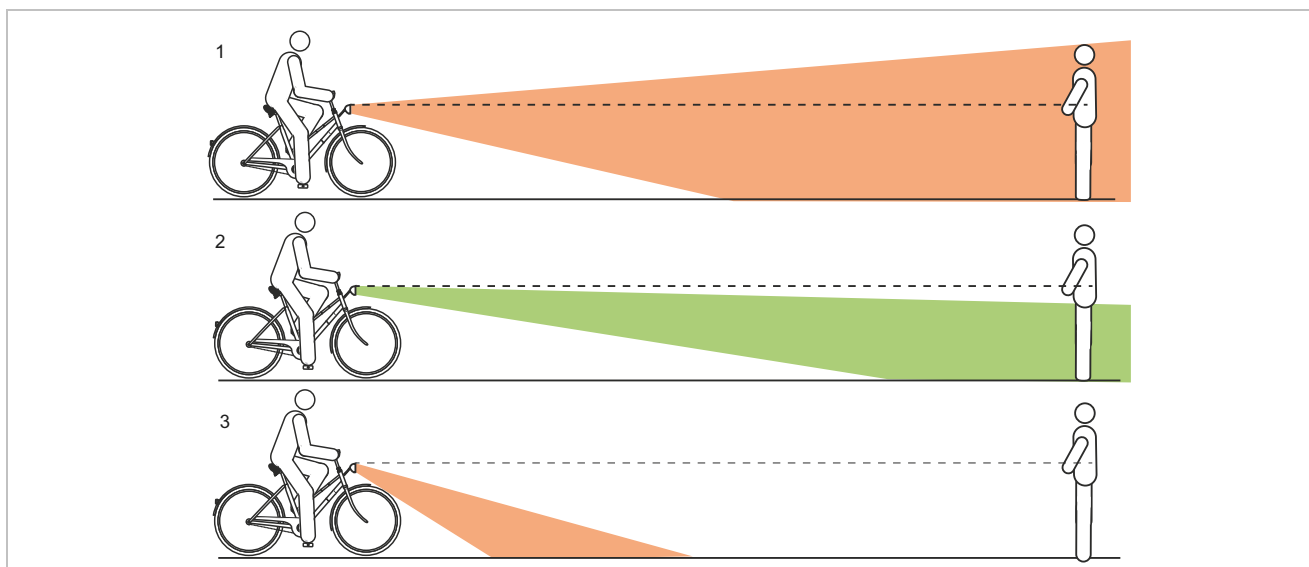

Figure 125: Light positioned too high (1), correctly (2) and too low (3)

6.4.16.4 Adjusting the headlight

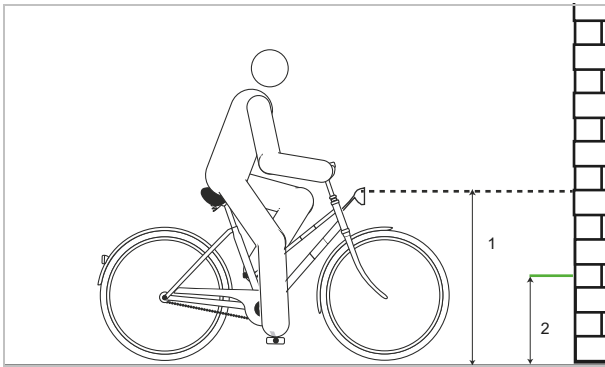

Figure 126: Measuring on the wall

- 1 Position the pedelec so that its front is facing a wall.
- 2 Mark the height of the headlight (1) on the wall with chalk.
- 3 Mark half the height of the headlight (2) on the wall with chalk.

- 4 Place pedelec 5 m in front of the wall.
- 5 Stand the pedelec up straight.

- 6 Hold the handlebars straight with both hands. Do not use the kickstand.
- 7 Switch on riding light.

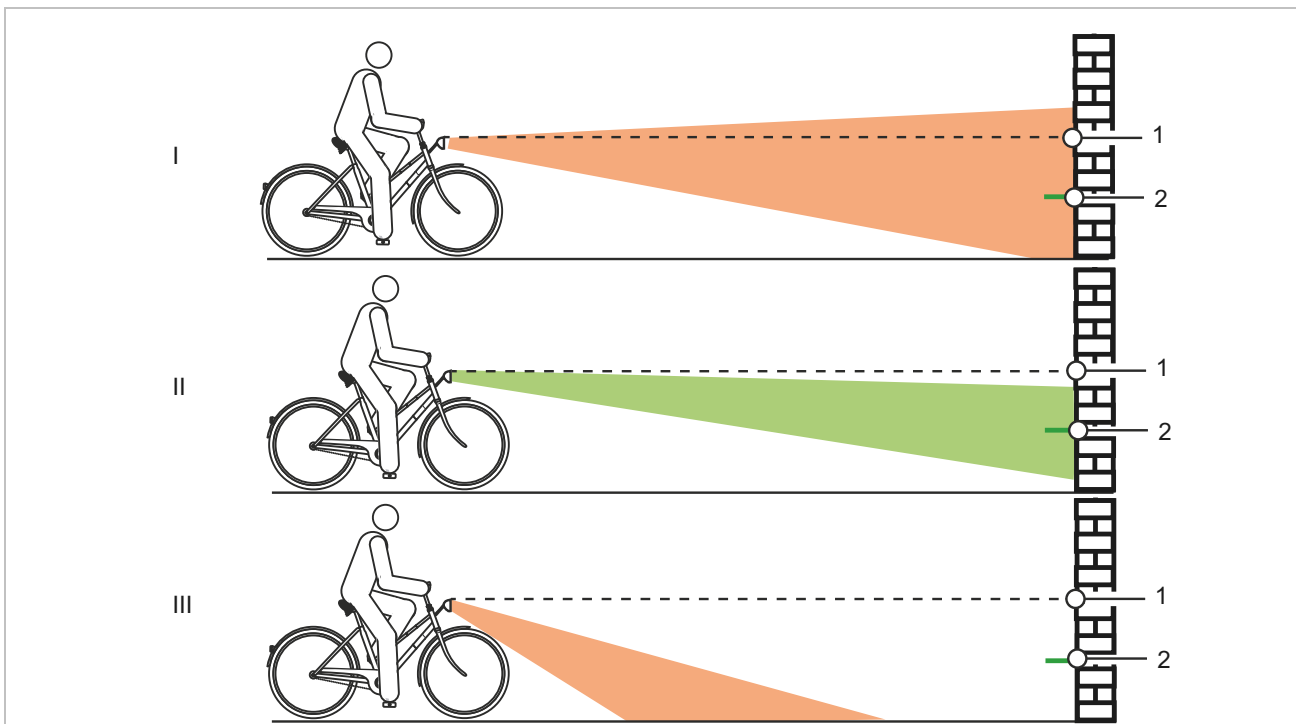

Figure 127: Light positioned too high (1), correctly (2) and too low (3)

- 8 Check the position of the light beam.
 - ▶ (I) if the upper edge of the light beam is above the headlight height mark (1), the riding light will dazzle. The headlight must be positioned lower.
 - ▶ (II) If the mid-point of the light beam is on or slightly below the mark showing half the height of the headlight (2), the lighting is optimally positioned.
 - ▶ (III) If the light beam is in front of the wall, move the headlight up.

6.4.17 Adjusting the on-board computer and FIT Compact

CAUTION

Crash caused by distraction

A lack of concentration while riding increases the risk of an accident. This may cause a crash with serious injuries.

- ▶ Never allow yourself to be distracted by the on-board computer.
- ▶ Stop pedelec if you want to make inputs on the on-board computer other than change the level of assistance. Only enter data when the bicycle is stationary.

Notice

- ▶ Do not use on-board computer as a handle. The on-board computer may become irreparably damaged if you use it to lift the pedelec.

6.4.17.1 Inserting the display

- 1 Place the display screen lower section into the mount.
- 2 Gently press the display downwards until you feel the display latch into place.

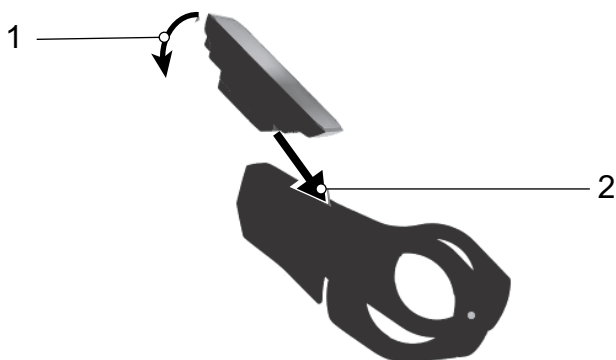

Figure 128: Inserting the display

6.4.17.2 Securing the display

It is possible to secure the display in its mount so that it cannot be removed.

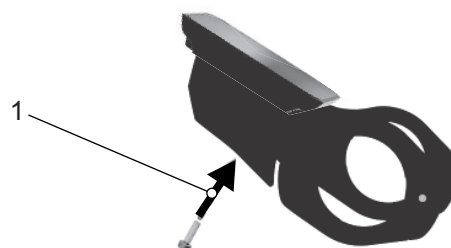

Figure 129: Fastening the blocking screw

- 3 Insert display into the mount.
- 4 Fasten the blocking screw into its designated thread in the display from below.

6.4.17.3 Removing the display

- ✓ The display can be removed if it is not secured.
- 1 Press the release switch.
 - 2 Remove display upwards.
- ⇒ The system is switched off by removing the display.

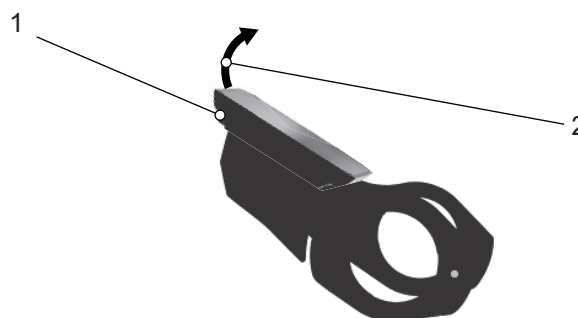

Figure 130: Removing the display

6.4.17.4 Operating the display

The display is operated using six buttons on the control panel.



Figure 131: Position of navigation rocker switch (1), plus (2) and minus (3) buttons

The rider can press the **navigation rocker switch (1)**

- to the left or right to access the different main screens and
- press to view the sub-screens.

The rider can use the **plus button (2)** and **minus button (3)**

- to access the sub-levels and
- scroll up and down a list.

6.4.17.5 Opening the Drive main menu

The DRIVE MAIN MENU screen will appear as soon as the display is switched on.



Figure 132: Screenshot of FIT Comfort DRIVE MAIN MENU

6.4.17.6 Opening other menus

- ▶ Press the **navigations button** to the left or right.
- ⇒ A new menu is displayed.

6.4.17.7 Changing the settings

- ✓ The pedelec is stationary. You cannot open and adjust the SETTINGS MENU while riding.
- ✓ The display is inserted and shows the DRIVE MAIN MENU.
- ▶ Press the **navigation rocker switch** until the last page of the SETTINGS MENU is displayed.

All system and service-relevant values can be read and changed in the settings. The settings menu structure is customised and may change when components or services are added.

Menu	Submenu
Reset values	
	→ <Trip Reset>
	→ <Factory Reset>
Default settings	
	→ <Language>
	→ <Time>
	→ <Date>
	→ <Units>
	→ <Time Format>
Connectivity	
	→ <Connect Komoot>
	→ <Connect Heart Rate Sensor>
My Bike	
	→ <Assistance>
	→ <Calibration Altitude>
	→ <Auto Backlight>
	→ <Auto Power Off>
	→ <Vibration Feedback>
Charging	
	→ <Normal Charge>
	→ <Fast Charge>

Table 110: Basic structure of FIT menu and sub-menu

Menu	Submenu
	→ <Charge to Storage>
	→ <LONG-LIFE mode>
Errors	
About	

Table 110: Basic structure of FIT menu and sub-menu

Setting the language

The menus can be set to the required language.

- 1 Open the SETTINGS MENU.
 - 2 Open <Localization><Language>.
 - 3 Follow the instructions on the display.
- ⇒ All menus are now displayed in the selected language.

Adjusting the clock

The clock can be adjusted.

- 1 Open the SETTINGS MENU.
 - 2 Open <Localization><Time>.
 - 3 Press on the **plus button** and **minus button** to set the current time in minutes and hours.
 - 4 Press the **navigation rocker switch**.
- ⇒ You now exit the menu. The time you entered is now saved.
- ▶ Press CANCEL on the display screen if you do not wish to adjust the clock.
- ⇒ You now exit the menu. The time you entered will not be saved.

Setting the date

The date can be adjusted.

- 1 Open the SETTINGS MENU.
 - 2 Open <Localization><Date>.
 - 3 Press the **plus button** and **minus button** to set the current date with the day and month.
 - 4 Press the **navigation rocker switch**.
- ⇒ You now exit the menu. The date you entered is now saved.
- ▶ Press CANCEL on the display screen if you do not wish to set the date.
- ⇒ You now exit the menu. The date you entered will not be saved.

Adjusting units

The displayed units can be shown using the metric or imperial system. The unit can be selected from the following variables:

Variable	Metric	Imperial
Distance	km	Mi
Speed	km/h	mph
Energy consumption	Wh/km	Wh/Mi
Temperature	°C	°F
Altitude above sea level	m.a.s.l.	ASL

Table 111: Units

- 1 Open the SETTINGS MENU.
- 2 Open <Localization><Units>.
- 3 Follow the instructions on the display.

All values are displayed in the selected unit.

6.4.17.8 Adjusting the time format

The clock can be displayed in 12-hour or 24-hour format.

- 1 Open the SETTINGS MENU.
 - 2 Open <Localization><Time Format>.
 - 3 Follow the instructions on the display.
- ⇒ The clock is displayed in the selected time format.

Connecting the Komoot app

The Komoot app can be connected to the FIT system. More information at: www.komoot.com/

- 1 Open the SETTINGS MENU.
 - 2 Open <Connectivity><Connect Komoot>.
 - 3 Follow the instructions on the display.
- ⇒ Komoot is now connected to the system.

Connecting heart rate sensor

Different heart rate sensors can be connected using the Bluetooth® function.

- 1 Open the SETTINGS MENU.
 - 2 Open <Connectivity><Heart rate sensor>.
 - 3 Follow the instructions on the display.
- ⇒ The heart rate sensor is now connected to the system.

Adjusting the assistance system

The assistance system be adjusted to individual requirements. The selected assistance setting has an impact on the three levels ECO, STD and AUTO in equal measure. The motor always delivers full assistance when set at HIGH.

- 1 Open the SETTINGS MENU.
 - 2 Open <My Bike><Assistance>.
 - 3 Use the **navigation rocker switch** to change to the required assistance setting:
 - If all bars are black in the indicator, assistance has been changed to the maximum setting. This setting means a shorter range.
 - If one black bar appears on the far left-hand side of the indicator, assistance has been changed to the minimum setting. This setting allows the maximum possible range at the ECO level of assistance.
 - 4 Press the **navigation rocker switch**.
- ⇒ The selected assistance setting is saved.

Calibrating the altimeter

The altimeter can be calibrated.

- 1 Open the SETTINGS MENU.
 - 2 Open <My Bike><Calibration Altitude>.
 - 3 Follow the instructions on the display.
- ⇒ The altimeter is now calibrated. Altitude measurement depends on the air pressure and deviations may arise if the air pressure fluctuates.

Adjusting the backlight

The backlight brightness can be adjusted.

- 1 Open the SETTINGS MENU.
 - 2 Open <My Bike><Auto Backlight>.
 - 3 – Select ON to use the backlight automatically adjusted to the ambient light.
 - Select OFF to adjust the backlight brightness between 10 and 100%.
 - 4 Press the **navigation rocker switch**.
- ⇒ The selected backlight brightness will be used.

Adjusting the auto switch-off

It is possible to adjust the time interval after which the drive system will automatically switch off when it is not being used.

- 1 Open the SETTINGS MENU.
 - 2 Open <My Bike><Auto Power Off>.
 - 3 Follow the instructions on the display.
- ⇒ The drive system switches off automatically after the set time interval when it is not being used.

Setting the vibration feedback

The vibration feedback can be adjusted.

- 1 Open the SETTINGS MENU.
- 2 Open <My Bike><Vibration feedback>.
- 3 – Select ON if you wish every press of a button and every active message to produce vibration feedback.
 - Select OFF if you do not wish vibration feedback to be produced.
 - Select ONLY WITH MESSAGES if you wish vibration feedback to be produced for messages only.

⇒ The selected vibration feedback is produced.

Adjusting charge mode

Charge mode and long-life mode can be adjusted. The faster the battery is charged, the shorter its life cycle will be. It can shorten the battery's service life by up to 50%.

- 1 Open the SETTINGS MENU.
- 2 Open <Charge>.
- 3 – Select <Normal> if you wish the battery to be charged at a normal rate.
 - Select <Fast> if you wish the battery to be charged at a fast rate.
 - Select <Charge to Storage> if you wish to store the battery for a longer period of time.
 - Select <LONG LIFE> if you wish to extend the battery's life cycle considerably. The battery capacity is reduced as a result.

⇒ The selected charge mode is implemented.

Resetting all tour data

All values in the TOUR MAIN MENU and SUB-MENU can be reset.

- Trip
- Time
- Trip Height
- Cons.
- MAX
- AVG.

- 1 Open the SETTINGS MENU.
- 2 Open <Reset values><Trip Reset>.
- 3 Follow the instructions on the display.

⇒ All tour data are reset.

Resetting to factory settings

The system settings can be reset to their factory settings.

- 1 Open the SETTINGS MENU.
- 2 Open <Reset values>< Factory Reset>.
- 3 Follow the instructions on the display.

⇒ All settings are reset to the factory settings.

Displaying error messages

- 1 Open the SETTINGS MENU.
- 2 Open <Messages>.

⇒ The list of current error messages is shown.

Displaying the software version

- 1 Open the SETTINGS MENU.
- 2 Open <About>.

⇒ The software versions for the individual components will be shown.

6.5 Accessories

Not included in price

6.5.1 Child seat



Child seats may only be used with the vehicle manufacturer's approval and only if they are approved for use on e-bikes.

WARNING

Crash caused by incorrect child seat

Pannier racks with a maximum load capacity under 27 kg and the down tube are unsuitable for mounting child seats and may break. Such an incorrect position may cause a crash with serious injuries for the pedelec rider or child.

- ▶ Never attach a child seat to the saddle, handlebars or down tube.

CAUTION

Crash caused by improper handling

When using child seats, the pedelec's handling characteristics and stability change considerably. This can cause a loss of control, a crash and injuries.

- ▶ You should practice how to use the child seat safely before using the pedelec in public spaces.

Risk of crushing due to exposed springs

The child may crush his/her fingers on exposed springs or open mechanical parts of the saddle or the seat post.

- ▶ Never install saddles with exposed springs if a child seat is being used.
- ▶ Never install suspension seat posts with open mechanical parts or exposed springs if a child seat is being used.

Notice

- ▶ Observe the legal regulations on the use of child seats.
- ▶ Observe the operating and safety instructions for the child seat system.
- ▶ Never exceed the maximum permitted total weight.

The specialist dealer will advise you on which child seat system is suitable for the child and the pedelec.

The specialist dealer must install the child seat the first time to ensure that it is safely fitted.

When installing a child seat, it must be ensured that:

- the seat and the seat fastening are suitable for the pedelec
- all components are installed and securely fastened
- shift cables, brake cables, hydraulic and electrical cables are adjusted as necessary
- the pedelec rider has optimum freedom of movement
- the maximum permitted total weight of the pedelec is observed.

The specialist dealer will provide instruction on how to handle the pedelec and the child seat.

6.5.2 Trailer



Trailers may only be used with the vehicle manufacturer's approval and only if they are approved for use on e-bikes.

CAUTION

Crash caused by brake failure

The braking distance may be longer if the trailer is carrying excessive load. The long braking distance can cause a crash or an accident and injuries.

- ▶ Never exceed the specified trailer load.

Notice

- ▶ The *operating* and safety instructions for the trailer system must be observed.
- ▶ Observe the statutory regulations on the use of bicycle trailers.
- ▶ Only use type-approved coupling systems.

A pedelec which is approved for towing a trailer will bear an appropriate adhesive label. You may only use trailers with a tongue load and weight which do not exceed the permitted values.

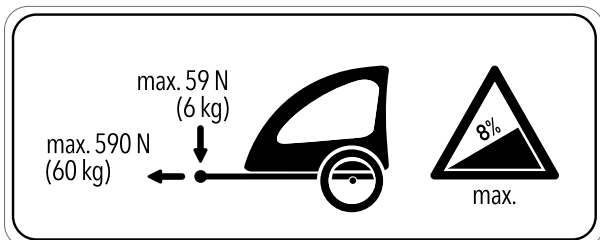

Figure 133: Trailer sign

The specialist dealer will advise you on which trailer system is suitable for the pedelec. The specialist dealer must install the trailer the first time to ensure that it is fitted safely.

6.5.2.1 Approval for trailer with Enviolo hub

Only applies to pedelecs with this equipment

Only compatible bicycle trailers are approved for ENVILO hub gears.

KETTLER

KETTLER Quadriga child trailer.

BURLY

Trailer	Adapter
Minnow Bee	Item no. 960038
Honey Bee	
Encore	
solo	
Cub	
D'Lite	
Normad	
Flatbed	
Tail Wagon	

CROOZER

Trailer	Adapter
Croozor Kid	Item no. 122003516, XL: +10 mm Item no. 122003716 Item no. 12200715 Croozor axle nut adapter with Thule coupling
Croozor Kid Plus	
Croozor Cargo	
Croozor Dog	

THULE

Trailer	Adapter
Thule Chariot Lite	Item no. 20100798
Thule Chariot Cab	
Thule Chariot Cross	
Thule Chariot Sport	
Thule Coaster XT	

6.5.2.2 Approval for trailer with ROHLOFF hub

Only applies to pedelecs with this equipment

ROHLOFF Speedhub 500/14

As a basic rule, it is permitted to use a trailer in combination with the ROHLOFF SPEEDHUB 500/14.

There must be **no component contact** with the cover of the ROHLOFF E-14 gear shift unit caused by pressure or tension at any time during assembly or when riding with the trailer **under any circumstances**.

Collision causing possible damage to the ROHLOFF E-14 gear shift unit can be avoided with suitable washers or special axle adapters (spacers or polygon) from the coupling manufacturer concerned.

Speedhub with A-12



Risk of an accident

The A-12 attachment screw has a very low screw-in depth. The screw or the thread in the axle plate can be damaged or ripped out if a trailer hitch is fitted directly onto the axle or the A-12 attachment screw. This may cause an accident with injuries.

- ▶ Never fit a trailer hitch directly on the axle and the A-12 attachment screw to a ROHLOFF Speedhub with an A-12 axle system in a 12 mm quick release axle frame.

6.5.3 Pannier rack



Front and rear pannier racks are only permitted with the vehicle manufacturer's approval and only if they are approved for use on e-bikes.

The specialist dealer will advise on choosing a suitable pannier rack.

The specialist dealer must install the pannier rack the first time to ensure that it is safely fitted.

When installing a pannier rack, the specialist dealer makes sure that the fastening mechanism is suitable for the pedelec and that all components are installed and firmly fastened. They will also ensure that shift cables, brake cables, hydraulic lines and electrical cables are adjusted as necessary, the person riding has optimum freedom of movement and the pedelec's maximum permitted total weight is not exceeded.

The specialist dealer will provide instruction on how to handle the pedelec and the pannier rack.

6.5.4 Panniers and cargo boxes



Panniers and cargo boxes are permitted if they are approved for use on e-bikes.

- ▶ Pay attention when loading the pannier rack and ensure correct load distribution.
- ▶ The maximum permitted total weight must not be exceeded during use.
- ▶ Use a paint protection film when attaching panniers. This will reduce abrasion on paint and wear on components.

The following panniers and cargo boxes are recommended:

Description	Article number
Protective cover for electrical components	080-41000 ff
Panniers, system component	080-40946
Rear wheel basket, system component	051-20603
Bicycle box, system component*	080-40947

Table 112: Recommended panniers and cargo boxes

6.5.5 Front baskets



Take care with front baskets because their load distribution is not fixed. They are only permitted with the vehicle manufacturer's approval and only if they are approved for use on e-bikes.

6.5.6 Bar ends



Handlebar ends are permissible provided they are professionally fitted to face the front at a specialist shop and only if they are approved for use on e-bikes. They must not seriously alter load distribution.

6.5.7 Kickstands



Kickstands are permitted if they are able to bear the weight of the pedelec.

We recommend a parking stand into which either the front wheel or rear wheel can be inserted securely for pedelecs which do not have a kickstand.

6.5.8 Additional battery headlight



Fitting additional battery headlights is permitted provided they comply with the laws of the country where the pedelec will be ridden and if they are approved for use on e-bikes.

6.5.9 Mobile holder

A holder for SP Connect mobile case is fitted to the stem.

- ✓ Observe the operating instructions for the mobile and the SP Connect mobile case.
- ✓ Use on tarmacked roads only.
- ✓ Protect mobile from theft.
- ▶ To attach: insert the SP Connect mobile case in the holder and turn 90° to the right.
- ▶ To release: turn the SP Connect mobile case 90° to the left and remove.

6.5.10 Suspension fork coil spring

If the desired suspension fork sag cannot be achieved after adjustment, the coil spring assembly must be replaced with a softer or harder spring.

- ▶ Fit a softer coil spring assembly group to increase the sag.
- ▶ Fit a harder coil spring assembly group to decrease the sag.

6.5.11 Fixed weather protection systems



Fixed weather protection systems are only permitted with the vehicle manufacturer's approval.

6.6 Personal protective equipment and accessories for road safety

Seeing and being seen is crucial in road traffic. The following requirements must be met for riding a pedelec safely on public roads.

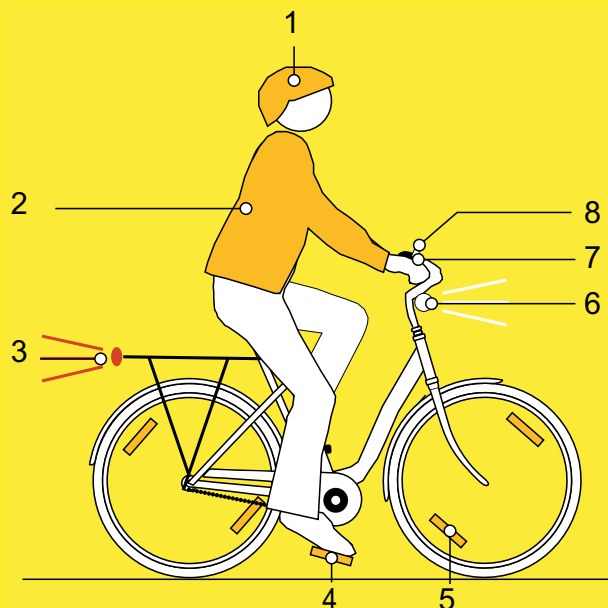

Figure 134: Road safety

- 1 The helmet must have a reflective strip or a light in a clearly visible colour.
- 2 **Cycle clothing** is essential at all times of year. Clothing should be retroreflective or as light as possible. Fluorescent materials are also suitable. High-visibility jackets and straps on your upper body ensure even greater safety. Never wear a skirt. Always wear trousers which reach down to your ankles instead.
- 3 The **large red reflector** with a “Z” registration mark and the **red rear light** must be clean. The rear light is attached high enough so that cars can see it (minimum height 25 cm). The rear light must work.
- 4 The two **reflectors on the two non-slip pedals** must be clean.
- 5 The **yellow spoke reflectors** on both wheel or the **white, fluorescent surface** on both wheels must be clean.
- 6 The **white front light** must work and must be positioned so that it does not dazzle other road users. The white front light and the **white reflector** must be clean at all times.

- 7 The **two separate brakes** on the pedelec must work at all times.
- 8 The **clear sounding bell** must be fitted and must work.

6.7 Before each ride

- ▶ Check pedelec before each ride; see Section [7.1](#).

Check list before each ride		
<input type="checkbox"/>	Check everything is sufficiently clean.	See Section 7.2
<input type="checkbox"/>	Check guards.	See Section 7.1.1
<input type="checkbox"/>	Check battery to ensure it is firmly in place.	See Section 6.16.2
<input type="checkbox"/>	Check lights.	See Section 7.1.13
<input type="checkbox"/>	Check brake.	See Section 7.1.14
<input type="checkbox"/>	Check suspension seat post.	See Section 7.1.9
<input type="checkbox"/>	Check pannier rack.	See Section 7.1.5
<input type="checkbox"/>	Check bell.	See Section 7.1.10
<input type="checkbox"/>	Check handles.	See Section 7.1.11
<input type="checkbox"/>	Check rear frame damper.	See Section 7.1.4
<input type="checkbox"/>	Check frame.	See Section 7.1.2
<input type="checkbox"/>	Check wheel concentricity.	See Section 7.1.7
<input type="checkbox"/>	Check quick releases.	See Section 7.1.8
<input type="checkbox"/>	Check mudguards.	See Section 7.1.6
<input type="checkbox"/>	Check USB cover.	See Section 7.1.12

- ▶ Be alert to any unusual noises, vibrations or odours while riding. Be alert to any unusual operating sensations when braking, pedalling or steering. This indicates material fatigue.
- ⇒ Take pedelec out of service if there are any deviations from the “Before each ride” checklist or any unusual behaviour. Contact specialist dealer.

6.8 Using the battery

✓ Switch off the battery and the drive system before removing or inserting the battery.

6.8.1 Removing the battery

1 Turn locking lever to right.

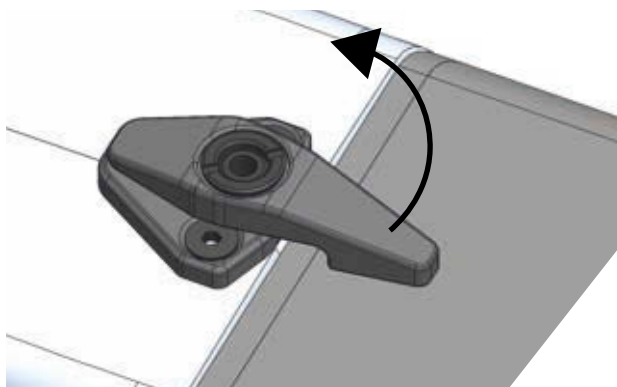

Figure 135: Opening the locking lever

2 Use your right hand to push the battery up into the frame.

⇒ The lock hook is disengaged in the frame.

3 Hold underneath the battery with your right hand. Press key towards the down tube.

⇒ The lock hook releases the battery.

4 The battery will now fall out of the frame or can be pulled out of the down tube, depending on how much space there is between the battery and down tube.

5 Remove the key from the lock.

6.8.2 Inserting the battery

1 Place the battery into the lower mount with the contacts facing the front.

2 Open the lock with the key.

3 Press the key towards the down tube and hold.

⇒ The lock hook in the frame clears the way for the battery.

4 Swivel the battery into the down tube. Apply a little pressure to push the battery into the frame.

5 Release the key.

6 The lock hook moves into the secure position and holds the battery.

7 Close the lock. Remove the key.

8 Turn locking lever to right.

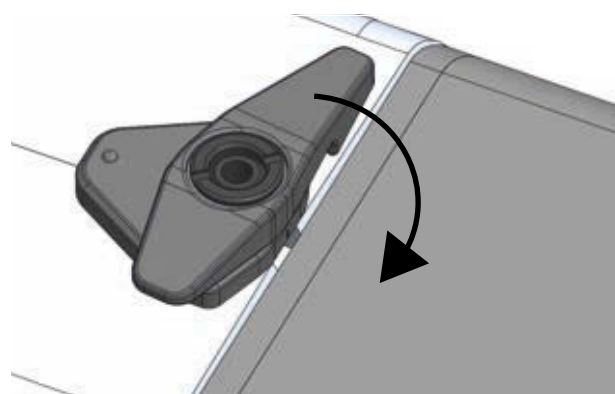

Figure 136: Closing the locking lever

9 Check the battery is firmly in position.

6.8.3 Charging the battery



CAUTION

Fire caused by overheated charger

The charger heats up when charging the battery. In case of insufficient cooling, this can result in fire or burns to the hands.

- ▶ Never use the charger on a highly flammable surface (e.g. paper, carpet etc.).
- ▶ Never cover the charger during the charging process.
- ▶ Never leave a battery charging unattended.

Electric shock caused by penetration by water

If water penetrates into the charger, there is a risk of electric shock.

- ▶ Never charge the battery outdoors.

Electric shock in case of damage

Damaged chargers, cables and plug connectors increase the risk of electric shock.

- ▶ Check the charger, cable and plug connector before each use. Never use a damaged charger.

Notice

- ▶ If an error occurs during the charging process, a system message is displayed. Remove the charger and battery from operation immediately and follow the instructions.
- ▶ Contact your specialist dealer if you are unable to recharge the battery or it is damaged.

- ✓ The battery can remain on the pedelec or can be removed for charging.
 - ▶ Remove the rubber cover from the battery.
 - ▶ Connect the mains plug of the charger to a normal domestic, grounded socket.
 - ▶ Connect the charging cable to the battery's charging port. Only use the charger supplied in the scope of delivery.
- ⇒ The charging process starts automatically.

The indicator shows the charge level during charging.

LED 1,2,3,4,5	Battery level
	100 - 80%
	79 - 60%
	59 - 40%
	39 - 20%
	19 - 10%
	9 - 0%

Table 113: Battery level indicator on rechargeable battery

When the drive system is switched on, the *display screen* shows the charging process.

Symbol	Charging
	0 - 5%
	5 - 39%
	40 - 59%
	60 - 70%
	70 - 90%
	90 - 100%

Table 114: Battery level indicator on on-board computer

⇒ The charging process is complete when the LEDs on the battery level indicator go out.

6.8.4 Waking the battery

- ✓ When not used for a longer period, the battery switches to sleep mode for self-protection. The LEDs on the battery level indicator do not light up.
- ▶ Press the **On-Off button (battery)**.
- ▶ The battery level indicator shows the charge level.

6.9 Straightening the quickly adjustable stem

Only applies to pedelecs with this equipment

- 1 Open stem clamping lever.



Figure 137: Example of All Up with open stem clamping lever

- 2 Pull handlebars into the highest possible position.

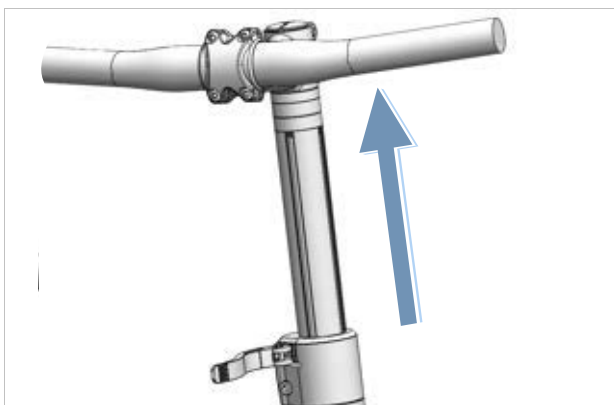

Figure 138: Example of All Up pulled into highest possible position

- 3 Turn handlebars 90° anti-clockwise so that they are straight.

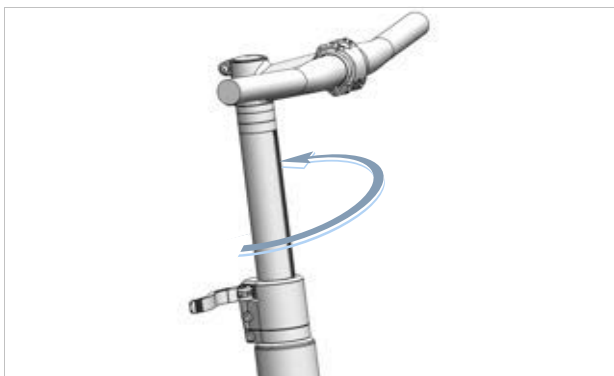

Figure 139: Example of All Up in straight position

- 4 Place handlebars at required height.
- 5 Close stem clamping lever.

6.10 Using the pannier rack



Crash caused by loaded pannier rack

The pedelec is handled differently with a loaded *pannier rack*, in particular when the rider needs to steer and brake. This can lead to a loss of control. This may cause a crash with injuries.

- ▶ You should practice how to use a loaded *pannier rack* safely before using the pedelec in public spaces.

Crushing the fingers in the spring flap

The spring flap on the *pannier rack* operates with a high clamping force. There is a risk of crushing the fingers.

- ▶ Never allow the spring flap to snap shut in an uncontrolled manner.
- ▶ Be careful where you position your fingers when closing the spring flap.

Crash caused by unsecured baggage

Loose or unsecured objects on the *pannier rack*, e.g. belts, may become caught in the rear wheel. This may cause a crash with injuries.

Objects which are fastened to the *pannier rack* may cover the *reflectors* and the *riding light*. Other users may not see the pedelec on public roads as a result. This may cause a crash with injuries.

- ▶ Secure any objects which are attached to the *pannier rack* sufficiently.
- ▶ Objects fastened to the *pannier rack* must never cover the *reflectors*, the *headlight* or the *rear light*.
- ▶ Distribute the baggage as evenly as possible between the left- and right-hand side.
- ▶ We recommend the use of panniers and baggage baskets.

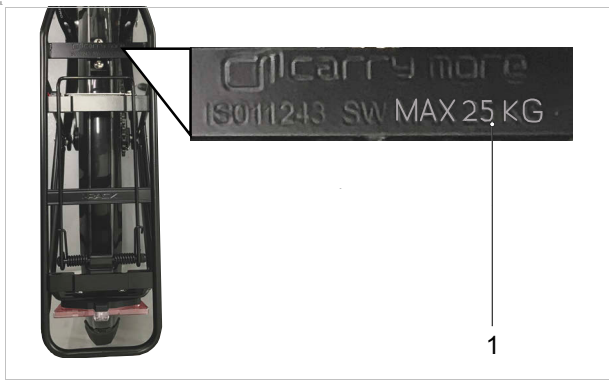

Figure 140: The maximum load bearing capacity is indicated on the pannier rack

- ▶ Pack the pedelec to its *maximum permitted total weight* (PTW) only.
- ▶ Pack the pedelec to the pannier rack's maximum load capacity only.
- ▶ Use the original pannier rack only.

6.11 Raising the kickstand

- ▶ Use your foot to raise kickstand completely before setting off.

6.12 Using the saddle

- ▶ Do not wear studded jeans as these can damage the saddle covering.
- ▶ Wear dark clothes for your first few rides as new leather saddles can stain clothing.

Riders often experience pain in the sitting bones, especially beginners or at the start of the season, after a longer break. The periosteum around the sitting bones is irritated as it is unaccustomed to the chafing. To reduce chafing:

- ▶ Wear cycling shorts with shock-absorbing seat padding.
 - ▶ Use a chamois cream or ointment.
- ⇒ The sensation of pain is reduced after five to six rides, although it may increase again after two to three weeks of riding.

6.12.1 Using the leather saddle

Sunlight and UV light tarnish the colour and cause the leather to dry out and fade.

- ▶ Park pedelec in the shade.
- ▶ Always use a saddle cover.

Moisture may cause the leather to detach from material beneath and mould may form.

- ▶ If the leather saddle gets wet, dry saddle completely.
- ▶ Always use a saddle cover.

6.13 Using the pedals

- ▶ The ball of the foot is placed on the pedal when riding and pedalling.

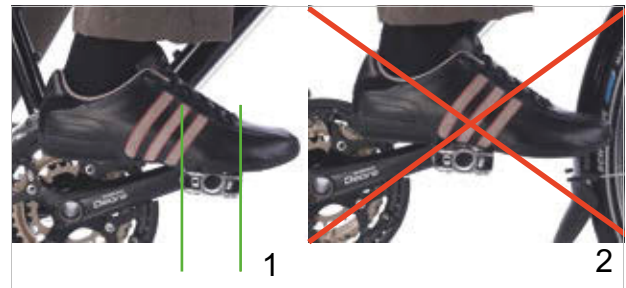

Figure 141: Correct (1) and incorrect (2) foot position on the pedal

6.14 Setting the saddle height with the remote control

Only applies to pedelecs with this equipment

6.14.1 Lowering the saddle

- 1 Sit on the saddle.
- 2 Press the remote control operating lever.
 - ⇒ The seat post will lower.
- 3 Release the remote control operating lever when you have reached the desired height.

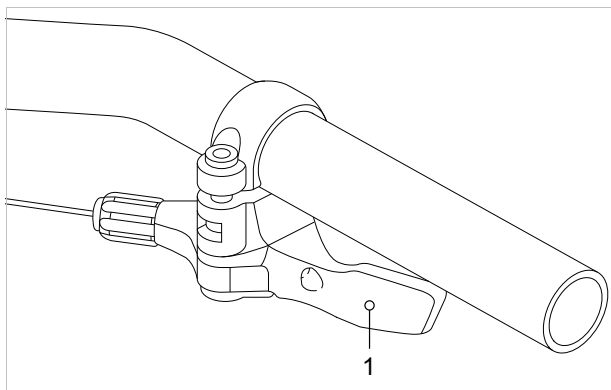

Figure 142: Remote control operating lever (1)

6.14.2 Raising the saddle

- 1 Remove any pressure from the saddle.
- 2 Press the remote control operating lever.
 - ⇒ The seat post will rise.
- 3 Release the remote control operating lever when you have reached the desired height.

6.15 Using the bell

- 1 Press the bell button downwards.
- 2 Let button spring back.

6.16 Using the handlebars

- ▶ Wear heavily padded cycling gloves.
 - ⇒ This helps protect sensitive areas of your palms.
- ▶ Vary your grip position continuously while riding.
 - ⇒ This prevents overstraining and fatigue in your hands.

6.16.1 Using multi-position handlebars

Only applies to pedelecs with this equipment

Multi-position handlebars are ideal for dynamic riding. The contoured ends of the handlebars, also known as horn handlebars, provide a variety of grip options. Changing muscle groups reduces strain on the hands, arms and back during longer rides.

- ▶ Vary your grip position continuously while riding.
 - ⇒ This prevents overstraining and fatigue in your hands.

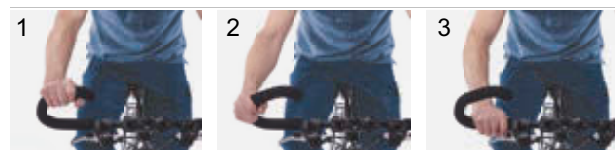

Figure 143: Grip positions on the multi-position handlebars

Grip position 1

The top grip position is suitable for riding slowly.

- ▶ Straighten your upper body without tensioning in this position.

Grip position 2 and 3

The middle and bottom grip position is suitable for fast rides and riding on inclines.

- ▶ In the middle position, hold the arm and wrist upright and relax tension.
- ▶ In the bottom position, place your upper body slightly lower. Keep your fingers close to the brake handle ready for use.

6.16.2 Using bar ends

Only applies to pedelecs with this equipment

Bar ends can be added to normal handlebars.

Adjustable bar ends feature a ball joint which you can use to choose the optimum position as required.

- ▶ Adjust bar ends correctly. To do so, your hand, elbow and shoulder must be in line with one another when the hand takes hold of the bar ends.
 - ▶ During the ride, keep varying your grip position between a flat (1) and upright (2) hand position.
- ⇒ This prevents overstraining, fatigue and numbness in your hands and fingers.



Figure 144: Grip positions on a bar end

6.16.3 Using leather handles

Only applies to pedelecs with this equipment

Sweat and grease from the skin are two of the greatest enemies of leather. They penetrate the surface of leather and cause it to disintegrate more quickly, meaning the leather can soften and abrade.

- ▶ Wear gloves.

Sunlight and UV light damage the colour and can cause the leather to dry out and fade.

- ▶ Park pedelec in the shade.

Moisture may cause the leather to detach from material beneath and mould may form.

- ▶ If the leather handles get wet, dry handles completely.

6.16.4 Adjusting the rear frame damper

- Before each ride, adjust the suspension and/or damping to the terrain if you have a rear frame damper.

Terrain	Position
Suspension	
Setting off	Open
Uphill or tarmacked roads	Lock out
Energy saved while riding on roads and/or for maximum pedalling efficiency on flat or smooth terrain	Threshold
Damping	
Downhill rides and terrain	Soft
Tarmacked roads	Hard

6.16.4.1 Adjusting the rear frame damper suspension

The suspension setting on the rear frame damper is optional and can have up to three settings:

- Open
- Locked out
- Threshold (optional)

Lockout (optional)

The suspension system absorbs a great deal of motor and muscle power during rides uphill or on optimally tarmacked roads. This increases energy consumption and reduces propulsion. It thus makes sense to lock the suspension on tarmacked roads and when riding uphill.

Threshold (optional)

Threshold mode increases drive efficiency over level terrain.

The threshold setting can be used to improve pedalling efficiency over flat, hilly, level or slightly rugged terrain. In threshold mode, higher pedelec speeds lead to greater impact force when a pedelec hits a bump, causing the suspension fork to deflect, and the bump is absorbed.

6.16.4.2 Locking out the ROCKSHOX rear frame damper

Only applies to pedelecs with this equipment

- ✓ Adjusting the rear frame damper rebound damper (see Section 6.4.15)
- ✓ The pedelec is stationary.

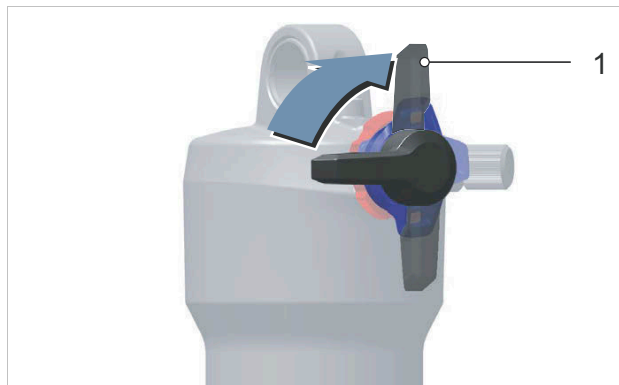

Figure 145: The compression adjuster's (black) closed position (1)

- ▶ Place locking lever (rear frame damper) into the closed position (1).
- ⇒ The rear frame damper is locked.

6.16.4.3 Opening the ROCKSHOX rear frame damper

Only applies to pedelecs with this equipment

- ✓ Adjusting the rear frame damper rebound damper (see Section 6.4.15)
- ✓ The pedelec is stationary.



Figure 146: The compression adjuster's (black) open position (1)

- ▶ Place **locking lever (rear frame damper)** in the open position (1).
- ⇒ The rear frame damper is now open.

6.16.4.4 Adjusting the ROCKSHOX rear frame damper threshold

Only applies to pedelecs with this equipment

- ✓ The pedelec's sag is configured.
- ✓ The pedelec's rebound damping has been set.
- ✓ The pedelec is stationary.

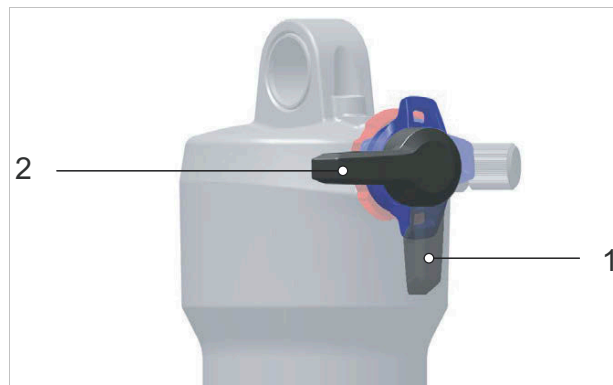

Figure 147: Open position (1) and position of the threshold (2) on the rear frame damper (black)

- ▶ Place **locking lever (rear frame damper)** in the threshold (2) position.
- ⇒ The threshold mode is enabled.
- ▶ To increase sensitivity to small bumps, turn **compression adjuster** anti-clockwise to decrease damping and hardness and increase the deflection speed.



Figure 148: Adjust the compression adjuster so that it is harder

6.16.5 Adjusting the rear frame damper compression damper

When optimally adjusted, the rear frame damper deflects quickly and unhindered when the bike hits bumps and absorbs a bump. Traction is retained (blue line).

The saddle rises slightly when absorbing a bump (green line).

The compression damper has two settings:

- Hard
- Soft



Figure 149: Optimum rear frame damper ride performance over bumps

Hard

A compression damper set to hard causes the rear frame damper to move higher in the deflection range. This makes it easier to improve efficiency and maintain momentum when pedalling or riding over uniformly hilly terrain and around bends.

Deflection feels somewhat harder on bumpy terrain.

Soft

Allows the damper to deflect quickly and easily. This makes it easier to maintain speed and momentum when riding over bumpy terrain.

Deflection feels somewhat less hard on bumpy terrain.

6.17 Electric drive system

6.17.1 Switching on the electric drive system



Crash caused by lack of readiness for braking

When the drive system is switched on, it can be activated by applying force on the pedals. There is a risk of a crash if the drive is switched on unintentionally and the brake is not reached.

- ▶ Never start the electric drive system and switch it off immediately if the brake cannot be reached safely and reliably.

-
- ✓ A sufficiently charged battery has been inserted into the pedelec.
 - ✓ The battery is firmly positioned.
 - ✓ The battery key has been removed.
 - ✓ The display has been inserted correctly into the mount.
 - ▶ Press and hold the **On-Off button (control panel)** for at least one second.
 - ⇒ The DRIVE MAIN MENU is shown on the display screen.
 - ⇒ The electric drive system is switched on.

6.17.2 Switching off the electric drive system

As soon as the rider stops pushing the pedals in normal mode or reaches a speed of 25 km/h, the drive system switches off the assistance system. The assistance system starts up again if the rider pushes the pedals and your speed is less than 25 km/h.

The drive system can switch off automatically to save energy if there is no activity from the rider for a longer period of time. The rider can adjust the interval until switch-off in the settings menu.

The rider can also switch off the drive system manually.

- ▶ Press and hold the **On-Off button (control panel)** for at least one second.
- ⇒ The LEDs on the operating mode and battery level indicator will go out.
- ⇒ The electric drive system is switched off.

6.18 Control panel

6.18.1 Using the push assist system



Injury from pedals or wheels

The pedals and the drive wheel turn when the push assist system is used. There is a risk of injury if the pedelec wheels are not in contact with the ground when the push assist system is used (e.g. when carrying the pedelec up stairs or when placing it on a bicycle rack).

- ▶ Only use the push assist mode when pushing the pedelec.
- ▶ You must steer the pedelec securely with both hands when using push assist.
- ▶ Allow for enough freedom of movement for the pedals.

The push assist helps move the pedelec. The speed is a maximum of 6 km/h in this case.

- ✓ The drive system is switched on.



Figure 150: Position of push assist button

- 1 Press the **push assist button** briefly.
 - ⇒ The push assist mode is switched on.
- 2 Press and hold the **push assist button** again within 3 seconds.
 - ⇒ Push assist is activated.

- 3 Release the **push assist button** to switch off the push assist system.
- 4 Push assist mode switches off if the **push assist button is released for ten seconds**. Push assist mode will also switch off automatically if the speed exceeds 6 km/h.

6.18.1.1 Using the riding light



Figure 151: Position of riding light button

- ✓ The drive system needs to be already switched on to turn on the *riding light*.

- ▶ Press the **riding light button**.

The lighting modes change in the following order:

	1 dimmed headlight (only applies to pedelecs with this equipment)
	2. Main beam (only applies to pedelecs with this equipment)
	3. Light off

Table 115: Overview of riding light symbols

6.18.2 Selecting the level of assistance

- ✓ The control panel is used to set how much the electric drive assists the rider when pedalling. You can change the level of assistance at any time, even when you are cycling.

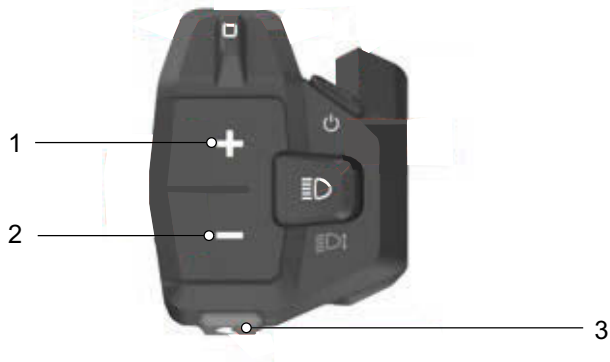

Figure 152: Position of plus button (1), minus button (2) and push assist button (3)

- ▶ Press the **plus button** to increase the level of assistance.
- ▶ Press the **minus button** to reduce the level of assistance.
- ⇒ The motor power used appears on the screen. The maximum motor power depends on the selected level of assistance.

6.18.2.1 Using the boost function

In the [BOOST] level of assistance, the motor power can be increased to [HIGH] irrespective of the selected level of assistance.

- 1 Press the **push assist button** to switch on the [BOOST] function.
- 2 Release the **push assist button** to switch off the [BOOST] function.

6.19 Using the brake



Crash caused by brake failure

Oil or lubricant on the brake disc in a disc brake or on the rim of a rim brake can cause the brake to fail completely. This may cause a crash with serious injuries.

- ▶ Never allow oil or lubricant to come into contact with the brake disc or brake linings or on the rim of a rim brake.
- ▶ If the brake linings have come into contact with oil or lubricant, contact specialist dealer to have the components cleaned or replaced.

If the brakes are applied continuously for a long time (e.g. while riding downhill for a long time), the fluid in the brake system may heat up. This may create a vapour bubble. This will cause air bubbles or water contained in the brake system to expand. This may suddenly make the lever travel wider. This may cause a crash with serious injuries.

- ▶ Release the brake regularly when riding downhill for a longer period of time.
- ▶ Use the front and rear wheel brakes alternately.

The motor's drive force is switched off during the ride as soon as the pedelec rider is no longer pedalling. The electric drive system does not switch off when braking.

- ▶ In order to achieve optimum braking results, do not pedal while braking.

6.19.1 Using the handbrake

Only applies to pedelecs with this equipment

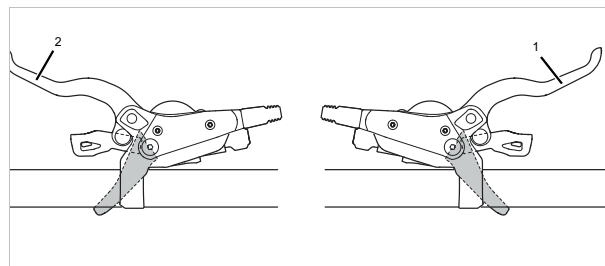

Figure 153: Handbrake, front (2) and rear (1) – SHIMANO brake used as an example

- ▶ Pull the left *handbrake* to apply the front wheel brake.
- ▶ Pull the right handbrake to apply the rear wheel brake.

6.19.2 Using the back-pedal brake

Only applies to pedelecs with this equipment

- 1 Move pedals a little beyond the 3 o'clock and 9 o'clock position.
- 2 Pedal in the opposite direction to the *direction of travel* until the desired speed has been reached.

6.19.3 Using Pinion gears

Only applies to pedelecs with this equipment

Pinion gears switch between 9 or 12 speeds. It is possible to switch between several gears in one shift action (e.g. from 06 to 02). Changing gear is possible when the crank is stationary or rotating backwards and is gentle on the gears.

It is possible to shift down gears (12-11-10 ... -01) without any restrictions when under load. The gear change will not be completed if there is too much pressure on the crank or on the pedal.

A mechanism in the gears allows the ride to shift up gears (01-02-03 ... -12) under load. This is possible for all gear shifts, except a change of gear between the different half-gears. The rider needs to take the pressure off the pedals briefly in this case.

- ▶ Always reduce the pressure on the pedals when shifting down gears (12-11-10 ... -01).

Applies to P1.12 motor

- ▶ Always reduce the pressure on the pedals when shifting up a gear from 04 to 05 or from 08 to 09.

Applies to P1.9 motor

Always reduce the pressure on the pedals when shifting up from 03 to 04 or from 06 to 07.

6.19.3.1 Shifting gear with E-Trigger TE1

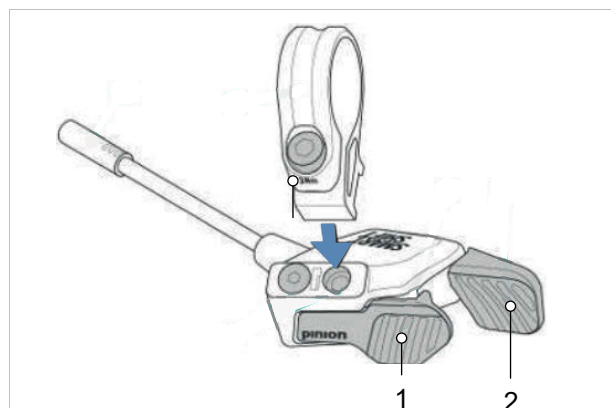

Figure 154: Pinion E-Trigger TE1 shifter

- 1 Front shifter
- 2 Rear shifter

- ▶ Push the front shifter (1) backwards to shift up.
- ▶ Push the front shifter (2) backwards to shift down.
- ⇒ The gear shift switches gear.
- ⇒ The crank occasionally drops about 10° after a gear change. This causes the bike to jerk until the pawl is securely engaged in the next tooth. This phenomenon cannot always be eliminated but will not cause damage to the gears.

6.20 Use suspension and damping

6.20.1 Locking the suspension

A suspension system is designed to cushion and compensate for unevenness on a surface whether the user is riding on bumpy cycle paths, dirt roads or off road.

A suspension system absorbs a great deal of motor and muscle power during rides uphill or on optimally tarmacked roads. This increases energy consumption and reduces propulsion. It is thus a good idea to lock the suspension on tarmacked roads and when riding uphill.

Some suspension forks thus feature a lockout on the crown or a remote lockout activated on the handlebars.

	Mode	Use
1	OPEN	Setting off
2	Middle position	Uneven terrain
3	LOCK	Uphill, tarmacked roads

6.20.1.1 Locking the SR SUNTOUR suspension fork

LORC-PCS LORC	LOR	LO	HLO	NLO
				

Table 116: Lockout on the crown on SR Suntour suspension forks

▶ Turn lockout (1) on the crown clockwise to LOCK.

⇒ The suspension fork is blocked.

▶ Turn lockout (1) on the crown anticlockwise to OPEN.

⇒ The suspension fork is open.

RL22-DUAL-L-2C-22	RL22-SINGLE-L-2C-22	RL22-SINGLE-U-2C-22 RL22-SINGLE-U-2C-32	SL9SC-RLO	
				

Table 117: SR Suntour suspension fork lockout on the handlebars

▶ Press locking lever (1) on the handlebars.

⇒ The suspension fork is blocked.

▶ Press release lever (2) on the handlebars.

⇒ The suspension fork is open.

6.20.2 Adjusting the suspension fork compression damper

The compression damper allows the rider to make quick adjustments to the suspension behaviour of the suspension fork to adapt to changes in terrain. It is intended for adjustments made during the ride.

It is a good idea to use the compression damper on

- bumpy sections
- marked shifts of weight at crossings and during cornering and braking.

When placed at an optimum setting, the suspension fork counteracts deflection on hilly terrain, remains higher in its deflection range and helps maintain speed when riding on terrain hilly sections.

The suspension fork also deflects quickly and unhindered when hitting bumps and cushions the bump when placed at an optimum setting. Traction is retained (blue line). The fork responds quickly to the bump. The headset and handlebars rise slightly when absorbing a bump (green line).

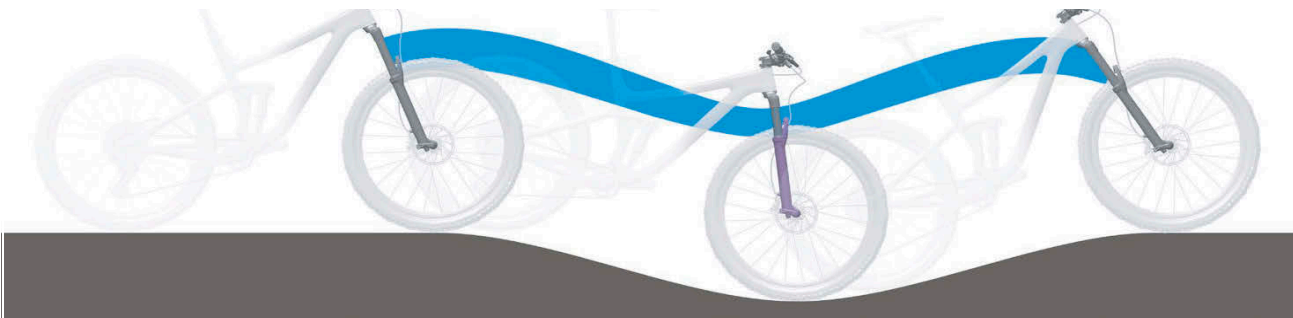

Figure 155: Optimum ride performance on hilly terrain

Compression damper set to hard

- Causes the suspension fork to move higher within the deflection range. This makes it easier for the rider to improve efficiency and maintain momentum over uniformly hilly terrain and around bends.
- Deflection feels somewhat harder on bumpy terrain.

Compression damper set to soft

- Causes the suspension fork to deflect quickly and easily. This makes it easier to maintain speed and momentum when riding on bumpy terrain.
- Deflection may feel somewhat less hard on more rugged terrain.



6.20.2.1 Using SR Suntour high-speed compression damping

A high speed is generated in the suspension fork, e.g. on a mogul slope or during landing after a jump.

The settings on the high-speed damper control the suspension behaviour of the fork during

- stronger impacts
- small, rapid impacts (e.g. stairs or mogul slopes)
- landings after quick, successive jumps.

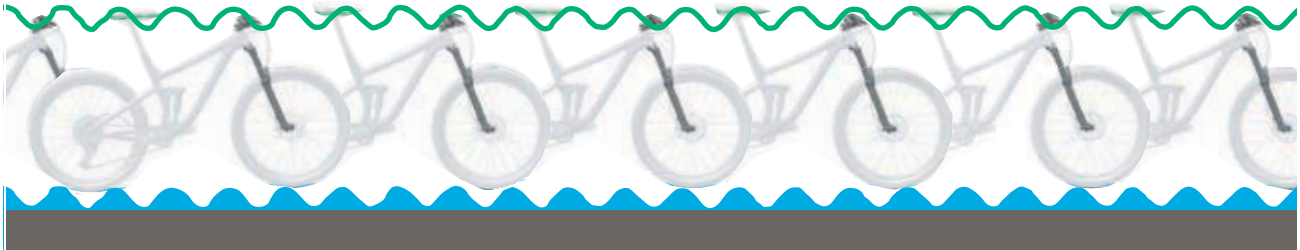

Figure 156: High-speed movements

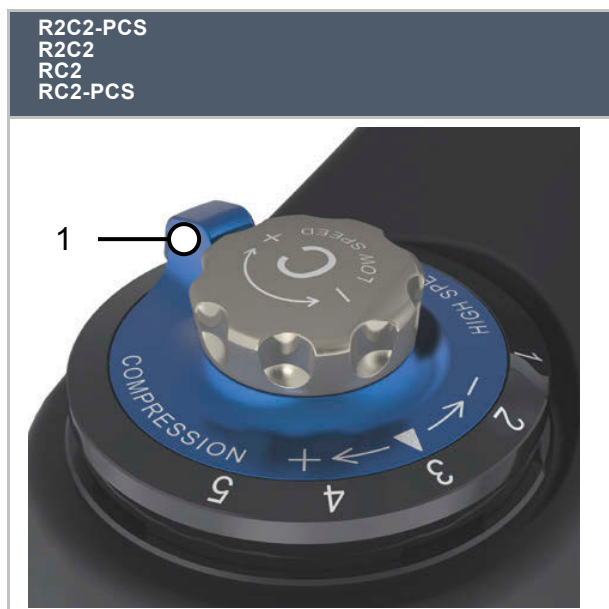

Table 118: High-speed lever (1) on the crown on the SR Suntour suspension fork

- ▶ Turn **high-speed lever (1)** on the crown clockwise gradually.
 - ⇒ The high-speed compression damper is placed in a harder setting.
- ▶ Gradually turn **high-speed lever (1)** on the crown anticlockwise.
 - ⇒ The high-speed compression damper is placed in a softer setting.

6.20.2.2 Using the SR Suntour low-speed compression damping

Low-speed movement in the suspension fork is caused, for example, by riding over bumps.

The settings on the high-speed damper control the suspension behaviour of the fork

- during staggered jumps
- during shifts in the rider's weight
- when force is applied slowly.



Figure 157: Low-speed movements

R2C2-PCS R2C2 RC2 RC2-PCS	RC-PCS RC	RLRC-PCS RLRC	LORC-PCS LORC

Table 119: Low-speed lever (1) on the fork crown on the SR Suntour suspension fork

- ▶ Gradually turn **low-speed lever (1)** on the crown clockwise.
- ⇒ The low-speed compression damper is placed in a harder setting.

- ▶ Gradually turn **low-speed lever (1)** on the crown anticlockwise.
- ⇒ The low-speed compression damper is placed in a softer setting.

6.21 Parking

Notice

Heat or direct sunlight can cause the *tyre pressure* to increase above the permitted maximum pressure. This can destroy the *tyres*.

- ▶ Never park the pedelec in the sun.
- ▶ On hot days, regularly check the *tyre pressure* and adjust it as necessary.

Moisture penetrating at low temperatures may impair individual functions due to the open structural design.

- ▶ Always keep the pedelec dry and free from frost.
- ▶ If the pedelec is used at temperatures below 3 °C, the specialist dealer must perform maintenance beforehand and prepare it for winter use.

The pedelec's force of weight may cause the kickstand to sink into soft ground, possibly causing the pedelec to topple over as a result.

- ▶ The pedelec must be parked on firm, level ground only.

- 1 Switch off drive system (see Section 6.17.2).
- 2 After getting off, use your foot to lower the kickstand completely before parking. Ensure that it is stable.
- 3 Park the pedelec carefully and check that it is stable.
- 4 Protect saddle with saddle cover if you park the pedelec outside.
- 5 Lock the pedelec with the bicycle lock.

6 Remove battery to protect against theft (see Section 6.16.1.1).

7 Clean and service pedelec after every ride; see Section 7.2.

Checklist after each ride

Cleaning		
<input type="checkbox"/>	Lights and reflectors	See Section 7.2.5
<input type="checkbox"/>	Brake	See Section 7.2.5
<input type="checkbox"/>	Suspension fork	See Section 7.2.1
<input type="checkbox"/>	Suspension seat post	See Section 7.2.6
<input type="checkbox"/>	Rear frame damper	See Section 7.2.7
<input type="checkbox"/>	Pedal	See Section 7.2.4
Care		
<input type="checkbox"/>	Suspension fork	See Section 3

6.21.1 Screwing in the quickly adjustable stem

Only applies to pedelecs with this equipment

Screw in the quickly adjustable stem to save space when parking.

- 1 Open stem clamping lever.

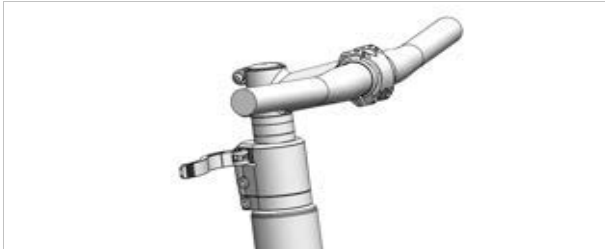

Figure 158: Example of All Up with open stem clamping lever

- 2 Pull handlebars into highest possible position.

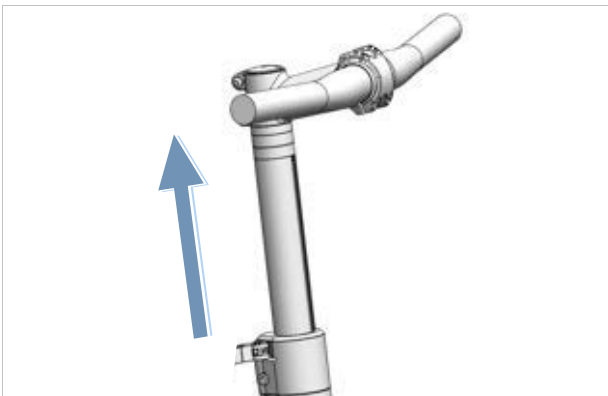

Figure 159: Example of All Up pulled into highest possible position

- 3 Turn handlebars 90° in a clockwise direction.

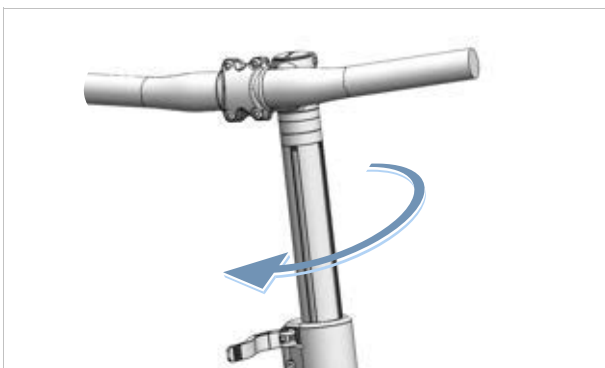

Figure 160: Example of All Up screwed in

- 4 Place handlebars at required height.
- 5 Close stem clamping lever.

6.21.2 Folding up the pedal

✓ Clean the pedal (see Section 7.2.4).

- 1 Use two fingers to pull the pedal folding latch (1) downwards and hold in position.

⇒ The folding system is unlocked.

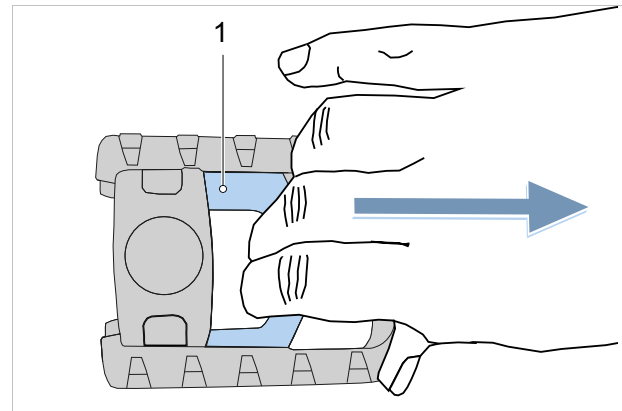

Figure 161: Pulling the pedal folding latch (1) downwards

- 2 Fold the pedal upwards.

- 3 Release your grip to carefully allow the pedal folding latch to return to its original position.

⇒ The pedal is folded away.

7 Cleaning, maintenance and inspection

- Clean, maintain and inspect pedelec as indicated on checklists.
Complying with these cleaning instructions can increase operational reliability, reduce wear on components, extend the service life of components and ensure safety.

Checklist: Before each ride		
<input type="checkbox"/>	Check everything is sufficiently clean	See Section 7.2
<input type="checkbox"/>	Check guards	See Section 7.1.1
<input type="checkbox"/>	Check battery to ensure it is firmly in place	
<input type="checkbox"/>	Check lights	See Section 7.1.13
<input type="checkbox"/>	Check brake	See Section 7.1.14
<input type="checkbox"/>	Check suspension seat post	See Section 7.1.9
<input type="checkbox"/>	Check pannier rack	See Section 7.1.5
<input type="checkbox"/>	Check bell	See Section 7.1.10
<input type="checkbox"/>	Check handles	See Section 7.1.11
<input type="checkbox"/>	Check rear frame damper	See Section 7.1.4
<input type="checkbox"/>	Check wheel concentricity	See Section 7.1.7
<input type="checkbox"/>	Check frame	See Section 7.1.2
<input type="checkbox"/>	Check quick releases	See Section 7.1.8
<input type="checkbox"/>	Check guards	See Section 7.1.6
<input type="checkbox"/>	Check USB cover	See Section 7.1.12
Checklist: After each ride		
<input type="checkbox"/>	Clean lights	See Section 7.2.1
<input type="checkbox"/>	Clean reflectors	See Section 7.2.1
<input type="checkbox"/>	Clean brake	See Section 7.2.5
<input type="checkbox"/>	Clean suspension fork	See Section 7.2.2
<input type="checkbox"/>	Maintain suspension fork	See Section 3
<input type="checkbox"/>	Clean suspension seat post	See Section 7.2.6
<input type="checkbox"/>	Clean rear frame damper	See Section 7.2.7
<input type="checkbox"/>	Clean the pedals	See Section 7.2.4

Checklist: weekly tasks		
	Clean chain	See Section 7.3.19
	City, folding, cargo and children's bikes and bicycles for young adults	When dry: every 10 days In wet conditions: every 2–6 days
<input type="checkbox"/>	Trekking and racing bikes	When dry: every 140... 200 km In wet conditions: every 100 km
	Mountain bikes	When dry: every 60... 100 km In wet conditions: after every ride
<input type="checkbox"/>	Belt (every 250–300 km)	See Section 7.3.18
	Servicing the chain	See Section 7.4.16 and 7.4.16.1
	City, folding, cargo and children's bikes and bicycles for young adults	When dry: every 10 days In wet conditions: every 2... 6 days
<input type="checkbox"/>	Trekking and racing bikes	When dry: every 140... 200 km In wet conditions: every 100 km
	Mountain bikes	When dry: every 60... 100 km In wet conditions: maintain all the time
<input type="checkbox"/>	Maintain all-round chain guard.	See Section 7.4.16.1
<input type="checkbox"/>	Check tyre pressure (at least once a week)	See Section 7.5.1.1
<input type="checkbox"/>	Check tyres (every 10 days)	See Section 7.5.1.2
<input type="checkbox"/>	Eightpins seat post Refill oil (every 20 hours)	See Section 7.4.19

Checklist: monthly tasks		
<input type="checkbox"/>	Cleaning the battery	See Section 7.3.2
<input type="checkbox"/>	Clean on-board computer	See Section 7.3.1
<input type="checkbox"/>	Clean on-board computer	See Section 7.3.1
<input type="checkbox"/>	Check disc brake linings (once a month or after braking 1,000 times)	See Section 3.4.4.3
<input type="checkbox"/>	Check rim brake brake linings (once a month or after braking 3000 times)	See Section 7.5.1.3
<input type="checkbox"/>	Checking the rim braking surface for wear	See Section 7.5.2.6
<input type="checkbox"/>	Clean handbrake	See Section 7.3.16.1
<input type="checkbox"/>	Clean brake disc	See Section 7.3.17
<input type="checkbox"/>	Check brake disc	See Section 7.5.2.4
<input type="checkbox"/>	Check brake Bowden cables	See Section 7.5.2.3
<input type="checkbox"/>	Clean pannier rack	See Section 7.3.4
<input type="checkbox"/>	Clean handles	See Section 7.3.7
<input type="checkbox"/>	Maintain handles	See Section 7.4.8
<input type="checkbox"/>	Check handbrake	See Section 7.5.2.1
<input type="checkbox"/>	Check hydraulic system	See Section 7.5.2.2
<input type="checkbox"/>	Clean cassette	See Section 7.3.15
<input type="checkbox"/>	Clean chain and all-round chain guard	See Section 7.3.19.1
<input type="checkbox"/>	Clean chain wheels	See Section 7.3.15
<input type="checkbox"/>	Clean leather handles	See Section 7.3.7.1
<input type="checkbox"/>	Maintain leather handles	See Section 7.4.8.2
<input type="checkbox"/>	Clean the leather saddle	See Section 7.3.9.1
<input type="checkbox"/>	Maintain leather saddle	See Section 7.4.11
<input type="checkbox"/>	Clean handlebars	See Section 7.3.6

Checklist: monthly tasks		
<input type="checkbox"/>	Cleaning the motor	See Section 7.3.3
<input type="checkbox"/>	Clean hub	See Section 7.3.12
<input type="checkbox"/>	Cleaning the frame	See Section 7.3.4
<input type="checkbox"/>	Clean tyres	See Section 7.3.10
<input type="checkbox"/>	Check back-pedal brake	See Section 7.5.2.5
<input type="checkbox"/>	Clean saddle	See Section 7.3.9
<input type="checkbox"/>	Clean seat post	See Section 7.3.8
<input type="checkbox"/>	Maintain seat post	See Section 7.4.9
<input type="checkbox"/>	Clean shifter	See Section 7.3.14.1
<input type="checkbox"/>	Cleaning gear shift	See Section 7.3.13
<input type="checkbox"/>	Clean shift cables	See Section 7.3.13
<input type="checkbox"/>	Check disc brake	See Section 7.5.2.4
<input type="checkbox"/>	Clean mudguard	See Section 7.3.4
<input type="checkbox"/>	Clean kickstand	See Section 7.3.4
<input type="checkbox"/>	Clean spokes and spoke nipples	See Section 7.3.11
<input type="checkbox"/>	Maintain spoke nipples	See Section 7.4.13
<input type="checkbox"/>	Clean rigid fork	See Section 7.3.4
<input type="checkbox"/>	Clean transmission	See Section 7.3.13
<input type="checkbox"/>	Clean front derailleur	See Section 7.3.15
<input type="checkbox"/>	Clean stem	See Section 7.3.5

Checklist: Quarterly tasks		
<input type="checkbox"/>	Check brake pressure point	See Section 7.5.2.1
<input type="checkbox"/>	Check rim brake (100 hours trip time or every 2,000 km)	See Section 7.5.2.6
<input type="checkbox"/>	Checking the spokes	See Section 7.5.1.3

Checklist: Tasks performed at least every six months (or every 1,000 km)	
<input type="checkbox"/>	Check Bowden cables gear shift See Section 7.5.10.2
<input type="checkbox"/>	Maintain handbrake See Section 7.4.18.1
<input type="checkbox"/>	Maintain carbon seat post See Section 7.4.9.2
<input type="checkbox"/>	Check gear shift electric cables See Section 7.5.10.1
<input type="checkbox"/>	Maintain suspension seat post See Section 7.4.9.1
<input type="checkbox"/>	Maintain rims See Section 7.4.10
<input type="checkbox"/>	Check rims See Section 7.5.1.3
<input type="checkbox"/>	Check rim hooks See Section 7.5.1.3
<input type="checkbox"/>	Maintain fork See Section 7.4.2
<input type="checkbox"/>	Check gear shift See Section 7.5.10
<input type="checkbox"/>	Maintain pannier rack See Section 7.4.3
<input type="checkbox"/>	Check chain See Section 7.5.10
<input type="checkbox"/>	Check derailleur gears See Section 7.5.10
<input type="checkbox"/>	Check chain tension See Section 7.5.3.1
<input type="checkbox"/>	Check wheel See Section 7.5.1
<input type="checkbox"/>	Maintain handlebars See Section 7.4.7
<input type="checkbox"/>	Check handlebars See Section 7.5.6
<input type="checkbox"/>	Check light See Section 7.5.4
<input type="checkbox"/>	Maintain hub See Section 7.4.12
<input type="checkbox"/>	Check hub See Section 7.5.10.4
<input type="checkbox"/>	Check nipple holes See Section 7.5.1.4
<input type="checkbox"/>	Maintain pedals See Section 7.4.15
<input type="checkbox"/>	Check pedal. See Section 7.5.8
<input type="checkbox"/>	Maintain frame See Section 7.4.1
<input type="checkbox"/>	Check belt tension See Section 7.5.3.3
<input type="checkbox"/>	Check saddle See Section 7.5.7
<input type="checkbox"/>	Maintain shifter See Section 7.4.14.2
<input type="checkbox"/>	Maintain rear derailleur articulated shaft See Section 7.4.14.1
<input type="checkbox"/>	Maintain rear derailleur jockey wheels See Section 7.4.14.1
<input type="checkbox"/>	Maintain kickstand See Section 7.4.5
<input type="checkbox"/>	Check kickstand stability
<input type="checkbox"/>	Check steering headset See Section 8.5.6

Checklist: Tasks performed at least every six months (or every 1,000 km)	
<input type="checkbox"/>	Servicing the stem See Section 7.4.6
<input type="checkbox"/>	Checking the stem See Section 7.5.5

Checklist: Annual tasks (or every 2000 km)	
<input type="checkbox"/>	Adjust hub with cone bearing See Section 8.5.6
<input type="checkbox"/>	Check nipple well (every 1,000 hours or every 2,000 km) See Section 7.5.1.5

 **WARNING**
Crash caused by brake failure

Oil or lubricant on the brake disc in a disc brake or on the rim of a rim brake can cause the brake to fail completely. This may cause a crash with serious injuries.

- ▶ Never allow oil or lubricant to come into contact with the brake disc or brake linings or on the rim of a rim brake.
- ▶ If the brake linings have come into contact with oil or lubricant, contact specialist dealer to have the components cleaned or replaced.
- ▶ After cleaning, servicing or repair, carry out a few test brake applications.

The brake system is not designed for use on a pedelec which is placed on its side or turned upside down. The brake may not function correctly as a result. This can cause a crash, which may result in injuries.

- ▶ If pedelec has been placed on its side or turned upside down, apply the brakes a couple of times before setting off to ensure they work as normal

The brake seals are unable to withstand high pressures. Damaged brakes can fail and cause an accident with injury.

- ▶ Never clean the pedelec with a pressure washer or compressed air.

Take great care when using a hosepipe. Never point the water jet directly at the seal section.

 **CAUTION**
Crash and falling caused by unintentional activation

There is a risk of injury if the electric drive system is activated unintentionally.

- ▶ Remove the battery before cleaning.

Notice

Water may enter the inside of the bearings if you use a steam jet. This dilutes the lubricant inside, the friction increases and, as a result, the bearings are permanently damaged in the long term. Water may also penetrate the electric components and damage them permanently.

- ▶ Never clean pedelec with a pressure washer, water jet or compressed air.

Greased parts, such as the seat post, the handlebars or the stem, may no longer be safely and reliably clamped.

- ▶ Never apply grease or oil to parts which are clamped.

Harsh cleaning agents such as acetone, methylene and trichloroethylene and solvents such as thinners, alcohol and corrosion protection can attack pedelec components and damage them permanently.

- ▶ Use approved care and cleaning products only.

7.1 Before each ride

Complying with these cleaning instructions is the only way to reduce wear on components, increase the operating hours and guarantee safety.

7.1.1 Checking the guards

The chain or belt guards, mudguards or the motor cover may break and fall off when the pedelec is transported or parked outside.

- ▶ Check that all guards are in place.
- ▶ Take pedelec out of service if a guard is damaged or missing. Contact specialist dealer.

7.1.2 Checking the frame

- ▶ Check frame for cracks, warping and damage to the paintwork.
- ▶ If there are any cracks, warping or damage to the paintwork, remove the pedelec from service. Contact specialist dealer.

7.1.3 Checking the fork

- ▶ Check fork for cracks, warping, tarnished components, leaked oil and damage to the paintwork. Also look at hidden parts on the underside.
- ⇒ If there are any cracks, warping, tarnished components, leaked oil or damage to the paintwork, remove the pedelec from service. Contact specialist dealer.

7.1.4 Checking the rear frame damper

- ▶ Check rear frame damper for cracks, warping, tarnished components, leaked oil and damage to the paintwork. Also look at hidden parts on the underside.
- ⇒ If there are any cracks, warping, tarnished components, leaked oil or damage to the paintwork, remove the pedelec from service. Contact specialist dealer.

7.1.5 Checking the pannier rack

- 1 Hold onto pedelec by its frame. Hold onto pannier rack with the other hand.
- 2 Move the pannier rack backwards and forwards to check that all screw connections are firmly in place.
 - ⇒ Tighten loose screws.
 - ⇒ Attach loose baskets permanently with a basket bracket or cable ties.

7.1.6 Checking the mudguards

- 1 Hold onto pedelec by its frame. Hold onto mudguard rack with the other hand.
- 2 Move the mudguard backwards and forwards to check that all screw connections are firmly in place.
 - ⇒ Tighten loose screws.

7.1.7 Check wheel concentricity

- ▶ Lift the front and rear wheels one after the other and spin each wheel when lifted.
- ⇒ If the wheel is loose or crooked when it turns, take pedelec out of service. Contact specialist dealer.

7.1.8 Checking the quick releases

- ▶ Check quick releases to ensure that all quick releases are firmly in their fully closed end position.
- ⇒ If a quick release is not firmly in its closed end position, open quick release and place in its end position.
- ⇒ If the quick release cannot be firmly placed in its end position, take pedelec out of service. Contact specialist dealer.

7.1.9 Checking the suspension seat post

- ▶ Deflect and let the suspension seat post rebound.
- ⇒ If you hear unusual noises when the suspension seat post deflects and rebounds, or it yields without any resistance, take pedelec out of service. Contact specialist dealer.

7.1.10 Checking the bell

- 1 Press the bell button downwards.
 - 2 Let button spring back.
- ⇒ If you do not hear a clear, distinct ring of the bell, replace bell. Contact specialist dealer.

7.1.11 Checking the handles

- ▶ Check the handles are firmly in place.
- ⇒ Screw loose handles firmly into place.

7.1.12 Checking the USB cover

- ⇒ If featured, check the position of the *cover on the USB port* on a regular basis and adjust if necessary.

7.1.13 Checking the riding light

- 1 Switch light on.
 - 2 Check that the headlight and rear light come on.
- ⇒ If the headlight and rear lights do not come on, take pedelec out of service. Contact specialist dealer.

7.1.14 Checking the brake

- 1 Pull both handbrakes when stationary.
 - 2 Push the pedals.
- ⇒ If no resistance is generated in the handbrake's usual position, take pedelec out of service. Contact specialist dealer.
 - ⇒ If the brake is losing fluid, take pedelec out of service. Contact specialist dealer.

7.2 After each ride

Complying with these cleaning instructions is the only way to reduce wear on components, increase the operating hours and guarantee safety.

The following items should be ready for use to clean the pedelec after each ride:









Tool		Cleaning agent	
 Cloth	 Bucket	 Water	 Dish-washing liquid
 Brush	 Fork oil	 Silicone or Teflon oil	 Acid-free lubricating grease

Table 120: Required tools and cleaning agents after each ride

7.2.1 Cleaning the riding light and reflectors



- 1 Clean headlight, rear light and reflectors with a damp cloth.

7.2.2 Cleaning the suspension fork



- 1 Remove dirt and deposits from the stanchions and deflector seals with a damp cloth. Check stanchions for dents, scratches, staining or leaking oil.
- 2 Lubricate the dust seals and stanchions with a few drops of silicone spray.
- 3 Maintain the suspension fork after cleaning.

7.2.3 Maintaining the suspension fork



- Treat dust seals with fork oil.

7.2.4 Cleaning the pedals



- Clean pedals with a brush and soapy water.

7.2.5 Cleaning the brake



- Clean dirt on the rim and brake components with a slightly dampened cloth.

7.2.6 Cleaning the suspension seat post



- Clean dirt on the articulated joints with a slightly dampened cloth immediately after a ride.

7.2.7 Cleaning the rear frame damper



- Clean dirt on the articulated joints with a slightly dampened cloth immediately after a ride.

7.3 Basic cleaning

Complying with these basic cleaning instructions is the only way to reduce wear on components, increase the operating hours and guarantee safety.

The following are required for basic cleaning:

Tool		Cleaning agent	
 Gloves	 Toothbrush	 Water	 Lubricant
 Cloth	 Paintbrush	 Dish-washing liquid	 Brake cleaner
 Sponge	 Watering can	 Degreaser	 Leather cleaner
 Brushes	 Bucket		

Table 121: Required tools and cleaning agents for basic cleaning

- ✓ Remove battery and on-board computer before thorough cleaning.

7.3.1 Cleaning the on-board computer and control panel



Notice

If water enters the on-board computer, it will be permanently damaged.

- ▶ Never immerse the on-board computer in water.
 - ▶ Never use a cleaning agent.
-
- ▶ Carefully clean the on-board computer and control panel with a soft, damp cloth.

7.3.2 Cleaning the battery



CAUTION

Risk of fire and explosion due to penetration by water

The battery is only protected from simple spray water. Penetration by water can cause a short circuit. The battery may self-ignite and explode.

- ▶ Keep contacts dry and clean.
- ▶ Never immerse the battery in water.

Notice

- ▶ Never use a cleaning agent.

- 1 Clean the battery electrical connections with a dry cloth or paintbrush only.
- 2 Wipe off the decorative sides with a damp cloth.

7.3.3 Cleaning the motor



Notice

If water enters the motor, it will be permanently damaged.

- ▶ Never open the motor.
 - ▶ Never immerse the motor in water.
 - ▶ Never use cleaning agents.
-
- ▶ Carefully clean the motor on the outside with a soft, damp cloth.

7.3.4 Cleaning the frame, fork, pannier rack, guards and kickstand



- 1 Soak the components with dish-washing detergent if the dirt is thick and ingrained.
- 2 After leaving it to soak for a short time, remove the dirt and mud with a sponge, brush and toothbrushes.
- 3 Rinse off the components with water from a watering can.
- 4 Wipe away oil stains with a degreaser.

7.3.5 Cleaning the stem



- 1 Clean stem with a cloth and soapy water.
- 2 Rinse off component with water from a watering can.

7.3.6 Cleaning the handlebars

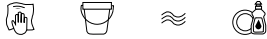

- 1 Clean handlebars, including handles and all gears or twist grip shifter, with a cloth and soapy water.
- 2 Rinse off component with water from a watering can.

7.3.7 Cleaning the handles



- 1 Clean handles with sponge, water and soapy water.
- 2 Rinse off component with water from a watering can.
- 3 Care for rubber handles after cleaning (see Section [7.4.8.1](#)).

7.3.7.1 Cleaning leather handles



Leather is a natural product and has similar properties to human skin. Regular cleaning and care help to prevent leather dehydrating, fading or becoming brittle or stained.

- 1 Remove dirt with a soft, damp cloth.
- 2 Remove stubborn stains with a leather cleaner.
- 3 Care for leather handles after cleaning (see Section [7.4.8.2](#)).

7.3.8 Cleaning the seat post



- 1 Clean seat post with a cloth and soapy water.
- 2 Rinse off component with water from a watering can.
- 3 Wipe away any grease or assembly paste residue with a cloth and degreaser.

7.3.9 Cleaning the saddle



- 1 Clean the saddle with lukewarm water and a cloth dampened with soapy water.
- 2 Rinse off component with water from a watering can.

7.3.9.1 Cleaning the leather saddle

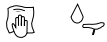

Leather is a natural product and has similar properties to human skin. Regular cleaning and care help to prevent leather dehydrating, fading or becoming brittle or stained.

- 1 Remove dirt with a soft, damp cloth.
- 2 Remove stubborn stains with a leather cleaner.
- 3 Care for leather saddle after cleaning (see Section [7.4.11](#)).

7.3.10 Cleaning the tyres

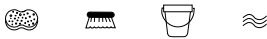

- 1 Clean tyres with a sponge, a brush and soap cleaner.
- 2 Rinse off component with water from a watering can.
- 3 Remove any embedded chips and small stones.

7.3.11 Cleaning the spokes and spoke nipples

- 1 Clean spokes from the inside to the outside with a sponge, brush and soapy water.
- 2 Clean rim with a sponge.
- 3 Rinse off component with water from a watering can.
- 4 Care for spoke nipples after cleaning (see Section [7.4.13](#)).

7.3.12 Cleaning the hub

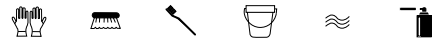

- 1 Put on protective gloves.
- 2 Remove dirt from hub with a sponge and soapy water.
- 3 Rinse off component with water from a watering can.
- 4 Wipe off oily dirt with a degreaser and a cloth.

7.3.13 Cleaning the switching elements



- 1 Clean gear shift and shift cables with water, a brush and dish-washing detergent.
- 2 Rinse off component with water from a watering can.

7.3.14 Cleaning the SRAM AXS rear derailleur



Notice

The battery will be permanently damaged if water enters the rear derailleur battery or the battery mount.

- ▶ If fitted, remove the rear derailleur battery from the SRAM rear derailleur and insert the battery separator into the rear derailleur before cleaning.
 - ▶ Never immerse the rear derailleur in water.
 - ▶ Never use acidic or degreasing agents on the electrical components.
 - ▶ Never use chemical cleaning agents or solvents as they can destroy the plastic components.
-
- ▶ Clean all derailleur components with a damp cloth.

7.3.14.1 Cleaning the shifter



- Carefully clean shifter with a damp, soft cloth.

7.3.15 Cleaning the cassette, chain wheels and front derailleur



- 1 Put on protective gloves.
- 2 Spray cassette, chain wheels and front derailleur with degreasing agent.
- 3 Clean coarse dirt with a brush after soaking for a short time.
- 4 Wash down all parts with dish-washing detergent and a toothbrush.
- 5 Rinse off component with water from a watering can.

7.3.16 Cleaning the brake

7.3.16.1 Cleaning the handbrake



- Carefully clean the handbrake with a damp, soft cloth.

7.3.17 Cleaning the brake disc



Notice

- Protect brake disc against lubricants and grease from hands.

- 1 Put on protective gloves.
- 2 Spray brake disc with brake disc cleaning spray.
- 3 Wipe with a cloth.

7.3.18 Cleaning the belt



Notice

- Never use aggressive (acid-based) cleaners, rust removers or degreasers when cleaning the belt.

- 1 Dampen a cloth with soapy water. Place the cloth on the belt.
- 2 Hold and apply slight pressure while slowly turning the rear wheel so that the belt passes through the cloth.

7.3.19 Cleaning the chain



Notice

- ▶ Never use aggressive (acid-based) cleaners, rust removers or degreasers when cleaning the chain.
- ▶ Never use gun oil or rust remover spray.
- ▶ Never use chain cleaning devices or chain cleaning baths.
- ▶ Have chain with all-round guard cleaned and cared for during major inspection.

- ✓ Place newspaper or paper towels underneath to collect dirt.
- 1 Slightly dampen a brush with dish-washing liquid. Brush both sides of the chain.
- 2 Dampen a cloth with soapy water. Place the cloth on the chain.
- 3 Hold and apply slight pressure while slowly turning the rear wheel, so the chain passes through the cloth.
- 4 Wipe off oily, dirty chains thoroughly with a cloth and degreaser.
- 5 Care for the chain after cleaning (see Section [7.4.16](#)).

7.3.19.1 Cleaning the chain, including all-round chain guard



Notice

The chain guard must be removed before cleaning. Contact specialist dealer.

- ▶ Clean water hole on the chain guard lower surface.
- ▶ Care for the chain after cleaning (see Section [7.4.16.1](#)).

7.4 Maintenance

Complying with these servicing instructions is the only way to reduce wear on components, increase the operating hours and guarantee safety.

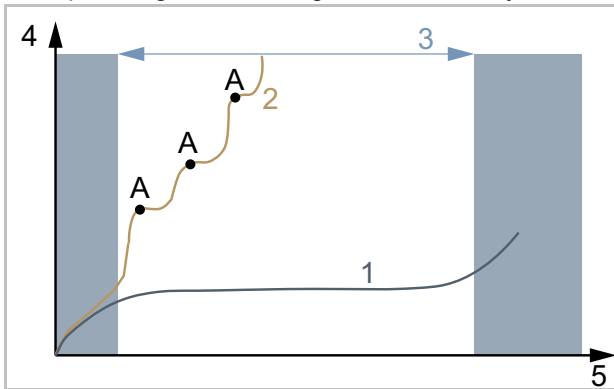

Figure 162: Diagram showing wear, operating hours (5) vs. material abrasion (4)

The service life (3) of an optimally serviced drive chain (1) is almost three times as long with lubrication (A) compared to a drive chain (2) lubricated on an irregular basis.

These tools and cleaning agents are required for servicing:











Tool		Cleaning agent	
			
Cloth	Toothbrush	Frame wax spray	Silicone or Teflon oil
			
		Acid-free lubricating grease	Fork oil
			
		Teflon spray	Spray oil
			
		Chain oil	Leather care product
			
		Battery terminal grease	

Table 122: Required tools and cleaning agents for servicing

7.4.1 Maintain frame



Notice

- ▶ Hard wax polish and protection wax are particularly resistant on gloss paintwork. These car accessory retail products are unsuitable for matt paint finishes.
- ▶ Try wax spray out on a small spot before application.

- 1 Dry frame with a cloth.
- 2 Spray frame with spray wax and leave to dry.
- 3 Wipe away any wax residue with a cloth.

7.4.2 Maintain fork



Notice

- ▶ Hard wax polish and protection wax are particularly resistant on gloss paintwork. These car accessory retail products are unsuitable for matt paint finishes.
- ▶ Try wax spray out on a small spot before application.

- 1 Dry fork with a cloth.
- 2 Spray frame care oil on frame and leave to dry.
- 3 Wipe away any wax residue with a cloth.

7.4.3 Maintain pannier rack



- 1 Dry pannier rack with a cloth.
- 2 Spray pannier rack with spray wax and leave to dry.
- 3 Wipe pannier rack with a cloth.
- 4 Protect chafing points on panniers with adhesive film. Replace worn adhesive film.
- 5 Maintain coil springs with silicone spray or wax spray from time to time.

7.4.4 Maintain mudguard



- Depending on the requirements for the material in the mudguard, apply hard wax polish, metal polish or a plastic care product as per the product instructions.

7.4.5 Servicing the kickstand



- 1 Dry kickstand with a cloth.
- 2 Spray kickstand rack with spray wax and leave to dry.
- 3 Wipe down kickstand with a cloth.
- 4 Lubricate the kickstand joints with spray oil.

7.4.6 Maintaining the stem



- 1 Spray painted and polished metal surfaces with wax spray and leave to dry.
- 2 Wipe away any wax residue with a cloth.
- 3 Apply silicone or Teflon oil to the stem shaft tube and the quick release lever pivot point with a cloth.
- 4 If you have a Speedlifter Twist, also apply oil to the unlocking bolt groove in the Speedlifter body.
- 5 Apply a little acid-free lubricant grease between the stem quick release lever and the sliding piece to reduce the quick release lever operating force.
- 6 If you have a stem with a cone clamp, apply a new protective layer of assembly paste onto the stem and fork steerer contact point once a year.

7.4.7 Maintaining the handlebars



- 1 Spray painted and polished metal surfaces with wax spray and leave to dry.
- 2 Wipe away any wax residue with a cloth.

7.4.8 Maintaining the handles

7.4.8.1 Maintaining rubber handles

- 1 Apply talcum powder to sticky rubber handles.

Notice

- ▶ Never apply talcum powder to leather or foam handles.

7.4.8.2 Maintaining the leather handles



Standard leather care products keep leather smooth and resistant, brighten its appearance and improve or replace stain protection.

- 1 Try leather care product out on a less visible spot before use.
- 2 Care for leather handles with a leather care product.

7.4.9 Maintaining the seat post

- 1 Carefully preserve screw connections with wax spray. In doing so, ensure that no wax is applied to the metal contact surfaces.
- 2 Replace the assembly paste protective layer on the metal contact surfaces on the seat post and seat tube every year.

7.4.9.1 Maintaining the suspension seat post



- 1 Lubricate articulated joints with spray oil.
- 2 Deflect and let the suspension seat post rebound five times. Remove any surplus lubricant with a clean cloth.

7.4.9.2 Maintaining the carbon seat post



Notice

Rain and puddle water can cause contact corrosion if carbon seat posts are used in an aluminium frame without protective assembly paste. It may then take a great deal of force to remove the seat post. The carbon seat post may break as a result.

- 1 Take out the carbon seat post.
- 2 Remove old assembly paste with a cloth.
- 3 Apply new assembly paste with a cloth.
- 4 Re-insert the carbon seat post.

7.4.10 Maintaining the rims



- ▶ Care for chrome rims, stainless steel rims and polished aluminium with chrome or metal polish. Never maintain the brake surface with polish.

7.4.11 Maintaining the leather saddle



Standard leather care products keep leather smooth and resistant, brighten its appearance and improve or replace stain protection.

- 1 Try leather care product out on a less visible spot before use.
- 2 Care for leather saddle from below with a leather care product. Only maintain the top of leather saddles with a leather care product if they are badly worn and dried-out.
- 3 Avoid wearing light-coloured trousers after care due to staining.

7.4.12 Maintaining the hub



- 1 Apply wax spray especially around the spoke holes. In doing so, ensure that no wax is applied to brake parts.
- 2 Treat rubber seals with a cloth with one or two drops of silicone spray. Never use oil if you have disc brakes.

7.4.13 Maintaining the spoke nipples



- 1 Apply wax spray onto the spoke nipples from the rim side.
- 2 Treat heavily corroded spoke nipples with a drop of penetrating or special care oil.

7.4.14 Maintaining the gear shift

7.4.14.1 Maintaining the rear derailleur articulated shafts and jockey wheel



- ▶ Treat front and rear derailleur articulated shafts and jockey wheels with Teflon spray.

7.4.14.2 Maintaining the shifter



Notice

- ▶ Never treat shifters with degreaser or penetrating oil spray.
- ▶ Lubricate articulated joints and mechanical parts which are accessible from outside with a few drops of spray oil or precision mechanics oil.

7.4.15 Maintaining the pedals



- 1 Treat pedals with spray oil. In doing so, ensure that no lubricant is applied to the pedal surfaces.
- 2 Lubricate seals and mechanical parts sparingly with a few drops of oil.
- 3 Remove any surplus lubricant with a clean cloth.
- 4 Spray metal foot rests with silicone spray.

7.4.16 Maintaining the chain



- ✓ Place newspaper or paper towels underneath to collect chain oil.
- 1 Lift rear wheel.
- 2 Turn the crank briskly in an anti-clockwise direction.
- 3 Use slight finger pressure to the chain oil bottle to apply a wafer-thin thread of oil to the chain links. The faster the crank is turned, the thinner the threads of oil will be.

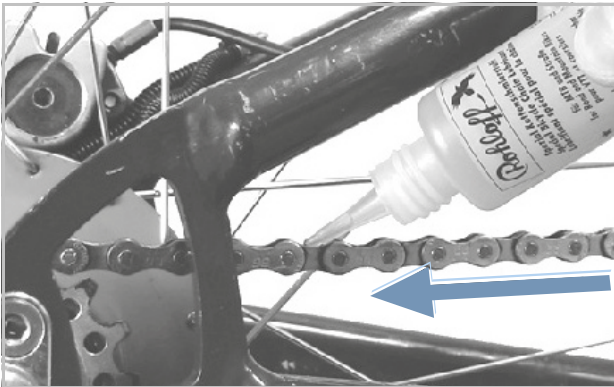

Figure 163: Lubricating the chain

- 4 Remove excessive chain oil with a cloth. If you apply too much oil, it will make the chain all the dirtier at a later point in time.
- 5 Leave chain oil to penetrate into the chain links for a few hours or overnight.

7.4.16.1 Maintaining the chain and all-round chain guard



- ✓ Place newspaper or paper towels underneath to collect chain oil.
- 1 Lift rear wheel.
- 2 Turn the crank briskly in an anti-clockwise direction.
- 3 Use slight finger pressure to the chain oil bottle to apply a wafer-thin thread of oil onto the chain links through the oil hole on the upper surface of the chain guard. The faster the crank is turned, the thinner the threads of oil will be.
- 4 Remove excessive chain oil with a cloth. If you apply too much oil, it will make the chain all the dirtier at a later point in time.
- 5 Leave chain oil to penetrate into the chain links for a few hours or overnight.

7.4.17 Maintaining the battery



- ▶ Grease plug terminals on the battery with terminal grease or contact spray from time to time.

7.4.18 Maintaining the brake

7.4.18.1 Maintaining the handbrake



Notice

- ▶ Never treat brake handbrake with degreaser or penetrating oil spray.
- ▶ Lubricate articulated joints and mechanical parts which are accessible from outside with a few drops of spray oil or precision mechanics oil.

7.4.19 Lubricating the Eightpins seat post tube

- ▶ Use a 2.5 ml syringe to carefully fill Eightpins Fluid V3 very slowly into the lubricating nipple on the outer tube.



Figure 164: Lubricating the Eightpins seat post

Notice

- ▶ Fill a maximum of 2.5 ml since otherwise the reservoir inside will overflow and the oil will spill into the frame.

7.5 Inspection

The following tools are required for an inspection:







	Gloves
	Ring spanners 8 mm, 9 mm, 10 mm, 13 mm, 14 mm and 15 mm
	Torque spanner Working range 5... 40 Nm
	by.schulz handlebars: TORX® bits: T50, T55, and T60
	Hex key 2 mm, 2.5 mm, 3 mm, 4 mm, 5 mm, 6 mm and 8 mm
	Phillips screwdriver
	Slotted-head screwdriver

Table 123: Tools required for inspection

7.5.1 Checking the wheel

- 1 Hold pedelec.
- 2 Hold onto the front or rear wheel and try to move the wheel sideways. In doing so, check to see if the wheel nuts or quick releases move.
 - ⇒ If the wheel moves or the wheel nut or quick release moves sideways, take pedelec out of service. Contact specialist dealer.
- 3 Lift pedelec slightly. Turn front or rear wheel. In doing so, check whether the wheel deflects sideways or outwards.
 - ⇒ If the wheel deflects sideways or outwards, take pedelec out of service. Contact specialist dealer.

7.5.1.1 Checking tyre pressure

Notice

If the tyre pressure is too low in the tyre, the tyre does not achieve its load bearing capacity. The tyre is not stable and may come off the rim.

If the tyre pressure is too high, the tyre may burst.

Tyres are wear parts and wear away due to fatigue, storage, environmental influences or mechanical impacts. Only optimum tyre pressure will guarantee greater safety, lower rolling resistance, effective protection against punctures and a longer service life.

Air loss

Even the most airtight tube will lose pressure on a continuous basis since the air pressures in a pedelec tyre are significantly higher and the wall thicknesses significantly finer than in a car tyre. Pressure loss of 1 bar per month can be regarded as normal. During this process, the pressure loss is significantly faster at high pressures and significantly slower at low pressures.

Checking tyre pressure

The permitted pressure range is indicated on the side of the tyre.



Figure 165: Tyre pressure specification in bar (1) and psi (2)

- ▶ Verify tyre pressure against the value noted in the pedelec pass every 10 days as a minimum.

Dunlop valve**Only applies to pedelecs with this equipment**

The tyre pressure cannot be measured on the simple Dunlop valve. You thus measure the tyre pressure in the filling hose while slowly pumping the bicycle air pump.

- ✓ It is recommendable to use a bicycle air pump with a pressure gauge.
- 1 Unscrew and remove the valve cap.
- 2 Undo the rim nuts.
- 3 Connect the bicycle air pump.
- 4 Pump up the tyre slowly and pay attention to the tyre pressure in the process.
- 5 Correct the tyre pressure to meet the specified value in the Pedelec pass.
- 6 If the tyre pressure is too high, unfasten the union nut, let air out and re-tighten the union nut.
- 7 Remove the bicycle air pump.
- 8 Screw the valve cap tight.
- 9 Screw the rim nut gently against the rim with the tips of your fingers.
- ⇒ Correct tyre pressure if necessary (see section 6.5.8.2).

Schrader valve**Only applies to pedelecs with this equipment**

- ✓ It is recommended to use an air pump at a filling station or a modern bicycle air with a pressure gauge. Older and simple bicycle air pumps are unsuitable for filling tyres via a Schrader valve.
- 1 Unscrew and remove the valve cap.
- 2 Undo the rim nuts.
- 3 Connect the bicycle air pump.
- 4 Pump up the tyre slowly and pay attention to the tyre pressure in the process.
- ⇒ The tyre pressure has been adjusted as per the specifications.
- 5 Remove the bicycle air pump.
- 6 Screw the valve cap tight.
- 7 Screw the rim nut gently against the rim with the tips of your fingers.
- ⇒ Correct tyre pressure if necessary (see section 6.5.8.2).

Presta valve**Only applies to pedelecs with this equipment**

- ✓ It is recommendable to use a bicycle air pump with a pressure gauge. You must observe the bicycle air pump operating instructions.
- 1 Unscrew and remove the valve cap.
- 2 Open the knurled nut around four turns.
- 3 Carefully attach the bicycle air pump so that you do not bend the valve insert.
- 4 Pump up the tyre slowly and pay attention to the tyre pressure in the process.
- 5 Correct the tyre pressure as per the specifications on the tyre.
- 6 Remove the bicycle air pump.
- 7 Tighten the knurled nut with your fingers.
- 8 Screw the valve cap tight.
- 9 Screw the knurled nut gently against the rim with the tips of your fingers.
- ⇒ Correct tyre pressure if necessary (see section 6.5.8.2).

7.5.1.2 Checking the tyres

The tread is far less important for bicycle tyres than it is for car tyres, for example. Consequently, tyres can still be used with a worn tread with the exception of tyres on mountain bikes.

- 1 Check the tread for wear. The tyre is worn if the anti-puncture protection or the carcass cords are visible.

Since resistance to punctures also depends on the thickness of the tread, it may make sense to change the tyre at an earlier stage.

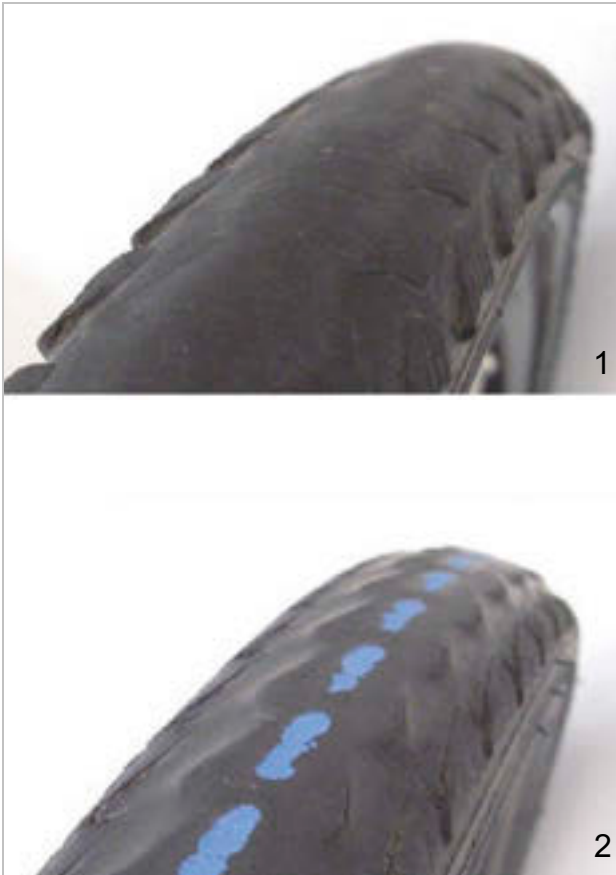

Figure 166: Tyres without a tread which can be replaced (1) and tyres with puncture protection showing through (2) must be replaced

- 2 Check the side walls for wear. If there are any cracks or tears, the tyre must be replaced.



Figure 167: Examples of fatigue cracks (1) and ageing cracks (2)

- 3 Replacing a wheel requires considerable mechanical expertise. If a tyre is worn, it needs to be replaced at a specialist dealer's.

7.5.1.3 Checking the rims



Crash caused by a worn rim

A worn rim can break and block the wheel. This may cause a crash with serious injuries.

- ▶ Check rim wear on a regular basis.
- ▶ Take pedelec out of service if the rim has any cracks or warping. Contact specialist dealer.

Rims are wear parts and wear away due to fatigue, mechanical impacts, environmental influences or due to braking if rim brakes are used.

- ▶ Check the rim well for wear.
- ⇒ The rims of a rim brake with invisible wear indicator are worn as soon as the wear indicator becomes visible in the area of the rim joint.
- ⇒ The rims with visible wear indicator are worn as soon as the black, all-round groove on the pad friction surface is no longer visible.
- ▶ We recommend that you also replace the *rims* at the same time as every second brake lining replacement.

7.5.1.4 Checking the nipple holes

Nipples cause fatigue and stress on the edge of the nipple hole.

- ▶ Check whether there are cracks on the edge of the nipple hole.

If there are cracks on the edge of the nipple hole, contact your specialist dealer.

7.5.1.5 Checking the nipple well

The nipple holes can weaken the tyre bed.

- ▶ Check to see if cracks are emerging from the nipple holes.
- ⇒ If there are cracks radiating from the nipple hole, contact your specialist dealer.

7.5.1.6 Checking the rim hooks

Mechanical impacts can warp the rim hooks. There is no longer a guarantee that a tyre can be fitted safely if this is the case.

- ▶ Check for twisted rim hooks.
- ⇒ Replace rims with twisted rim hooks. Never repair the rim with pliers and bend the hook back.

7.5.1.7 Checking the spokes

- ▶ Press spokes slightly together with your thumb and index finger. Check to ensure that the tension is the same for all spokes.
- ⇒ Contact your specialist dealer if the spokes are loose or are tensioned differently.

7.5.2 Checking the brake system



Crash caused by brake failure

Worn brake discs and brake linings and a lack of hydraulic fluid in the brake cable reduce the braking power. This may cause a crash with serious injuries.

- ▶ Check brake disc, brake linings and the hydraulic brake system regularly. Contact specialist dealer.

The inspection interval for the brake depends on how often it is used and the weather conditions. If the pedelec is used under extreme conditions such as rain, dirt or high mileage, inspection must be performed more frequently.

7.5.2.1 Checking the handbrake

- 1 Check that all screws in the handbrake are firmly in place (see Section 8.5.10).
- 2 Tighten loose screws.
- 3 Check that handbrake is torsionally rigid on the handlebars (see Section 8.5.10).
- 4 Tighten loose screws.
- 5 Check that there is a gap of at least 1 cm between the handbrake and the handle when the handbrake is fully applied.
- 6 Adjust the grip distance if the gap is too narrow (see Section 6.4.9.5).
- 7 Check the braking effect by pedalling while pulling the handbrake.
 - ▶ If the braking power is too weak, adjust the brake pressure point.
 - ▶ Contact your specialist dealer if the pressure point cannot be reached.

7.5.2.2 Checking the hydraulic brake system

- 1 Pull on the handbrake and check whether any brake fluid leaks out of the lines, connections or on the brake linings.
- 2 If any brake fluid leaks from anywhere, take pedelec out of service. Contact specialist dealer.
- 3 Pull brake handbrake and hold several times.
- 4 If you are unable to clearly detect the pressure point and it changes, the brake needs to be bled. Contact specialist dealer.

7.5.2.3 Checking the Bowden cables

- 1 Pull on handbrake several times. Check whether the Bowden cables get stuck or they make scraping noises.
- 2 Check the physical condition of the Bowden cables for visible damage and check to see if wire strands are broken.
- 3 Have defective Bowden cables replaced. Contact specialist dealer.

7.5.2.4 Checking the disc brake

Only applies to pedelecs with this equipment

Checking the brake linings

- ▶ Check that the brake linings are no less than 1.8 mm wide at any point and there are no less than 2.5 mm between the brake lining and supporting plate.



Figure 168: Checking the brake lining when fitted with the help of the transport safety wear gauge

- 1 Check brake linings for damage and thick dirt.
 - ⇒ Have damaged or very dirty brake linings replaced. Contact specialist dealer.
- 2 Pull handbrake and hold.
- 3 In doing so, check whether the transport safety wear gauge can fit between the brake lining supporting plates.
 - ⇒ If the transport safety wear gauge fits between the supporting plates, the brake linings have not reached their wear limit.
 - ⇒ Contact your specialist dealer if they are worn.

Checking the brake discs

- ✓ Put on gloves as the brake disc is very sharp.
- 1 Take hold of brake disc and wiggle it gently to check whether the brake disc is positioned against the wheel free of backlash.
 - 2 Check that the brake linings move steadily and symmetrically back towards the brake disc when you pull and release handbrake.
 - ⇒ If the brake disc can be moved or the brake linings move erratically, contact your specialist dealer.
 - 3 Check that the brake disc is no less than 1.8 mm thick at any point.
 - ⇒ If the brake disc is under the wear limit and is less than 1.8 mm thick, the brake disc must be replaced. Contact specialist dealer.

7.5.3 Checking the belt

7.5.3.1 Checking the belt for wear

► Check belt for indications of wear:

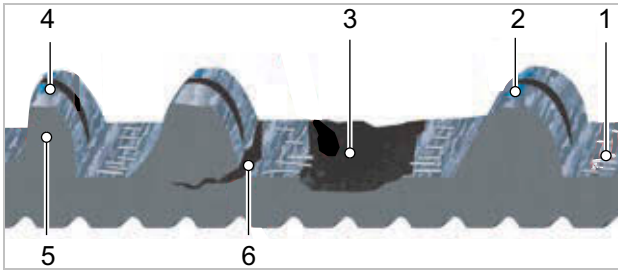

Figure 169: Indications of wear on a belt

- 1 Carbon tensile fibres are exposed
- 2 Worn webbing with visible polymer
- 3 Missing belt tooth
- 4 Imbalance
- 5 Shark tooth
- 6 Cracks

⇒ If there is one or more indications of wear, contact your specialist dealer. The belt needs to be replaced.

7.5.3.2 Checking the belt sprockets for wear

► Check belt sprocket.

⇒ The tooth profile is rounded and the teeth are thick. The belt sprocket does not need to be replaced.

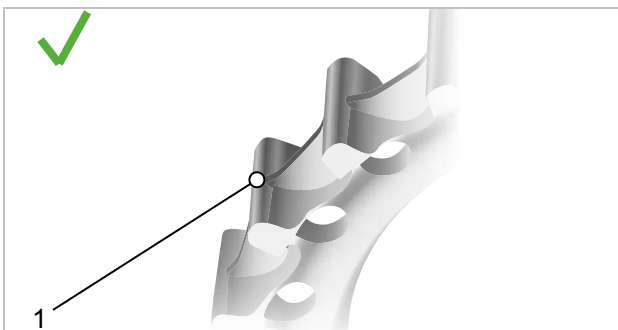

Figure 170: Optimum tooth profile

⇒ The tooth profile is pointed and teeth have worn thinner. Contact specialist dealer. The belt sprocket does need to be replaced.

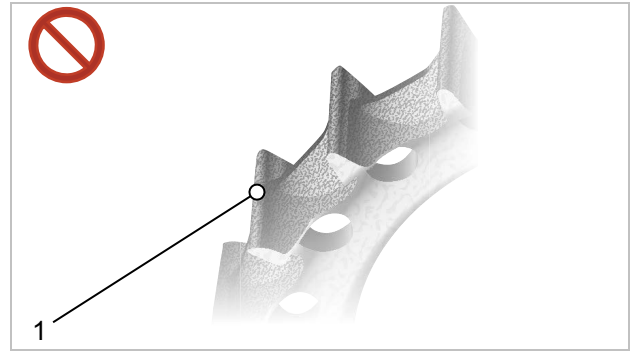

Figure 171: Worn tooth profile

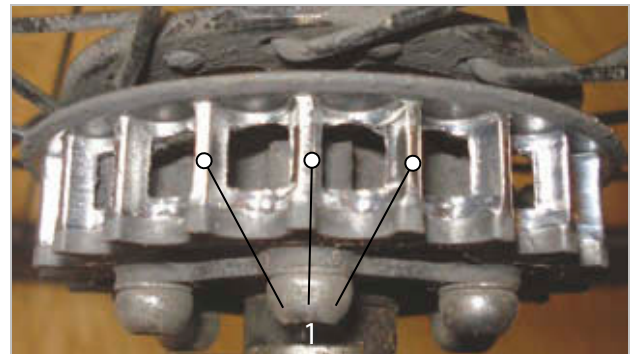

Figure 172: Photo showing example of worn tooth profile

7.5.3.3 Checking the belt tension

If the belt tension is too low, this can cause the system to skip over a tooth or slip, i.e. the teeth on the belt slip over the teeth on the rear wheel belt sprocket. Excessive tension can cause damage to the bearings, sluggishness in the system and increased wear on the electric drive system.

The adjustment of the belt tension varies depending on the pedelec. Common tensioning systems include angled or vertical drop-outs, horizontally sliding dropouts and eccentric bottom bracket axle.

There are three common methods of measuring belt tension:

- Gates Carbon Drive mobile app for iPhone® and Android®,
- Gates KrikIt tension meter and
- Eco tension tester.

With any of these methods, the tension along the belt may vary slightly, so you should repeat the process several times. Turn the pedal a quarter after each measurement. Measure again.

The tools measure the tension only. They do not provide specifications for the required voltage. The table below contains specifications for the correct tensioning range for Gates Carbon Drive belts.

	Steady pedalling	Sports usage
MTBs* and single-speed bicycles	45– 60 Hz (35– 45 lbs)	60– 75 Hz (45– 53 lbs)
Hub gear/pinion gear	35– 50 Hz (28– 40 lbs)	

Table 124: Specifications for tensioning

* The CDN and SideTrack systems are not permitted for mountain bikes, e-bikes with mid-drive motor or gears, bikes without a gear shift or for trekking or touring bikes.

These tension specifications are designed as initial guidance and may have to be corrected upwards or downwards depending on the body size, gear ratio and the force applied to the pedals.

Gates Carbon Drive mobile app



The Gates Carbon Drive mobile app measures the belt tension based on the belt's natural frequencies (Hz). To do so, the app uses the phone's mic to record the sound of the belt and determines the main frequency.

- ✓ Download Gates Carbon Drive mobile app free of charge from the App Store or Google Play on your mobile phone.
- ✓ Measure in a quiet environment.
- ✓ Ensure that the phone microphone is switched on.

- 1 Open app.
 - 2 Click on the voltage symbol.
 - 3 Click on **MEASURE**.
 - 4 Point phone microphone towards the belt.
 - 5 Pluck the belt so that the belt vibrates like a guitar string.
 - 6 It is recommended to take several measurements for comparison. Turn the crank a quarter. Repeat frequency measurement.
 - 7 Check the belt frequency displayed against the specifications for tensions in Table [w Tabelle 124, Seite 177].
- ⇒ If the value is higher than the specification, reduce belt tension.
- ⇒ If the value is within the specified range, the belt tension has been correctly adjusted.
- ⇒ If the value is lower than the specification, increase belt tension.

Gates KrikIt tension meter

Not included in price

- ✓ Check that the measurement indicator is at the very bottom.
- 1 Extend index finger into the finger loop. Place on the check gauge.

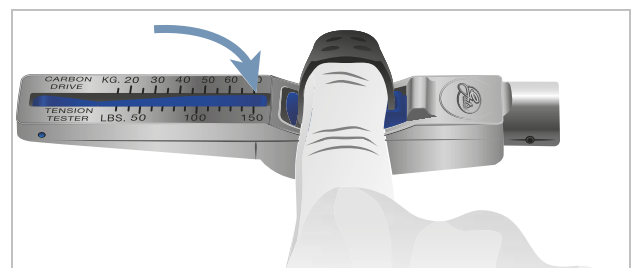

Figure 173: Index finger in the check gauge

- 2 Position check gauge on the upper surface of the belt. Position the check gauge in the middle of the belt length.

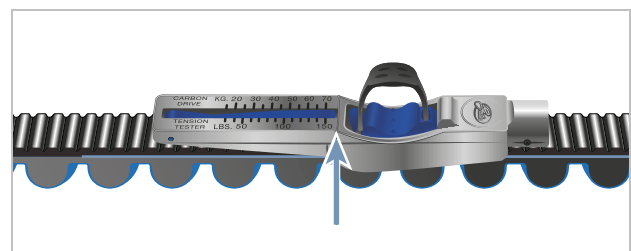

Figure 174: Check gauge on belt

- 3 Press the check gauge down with just one finger until it clicks into place.

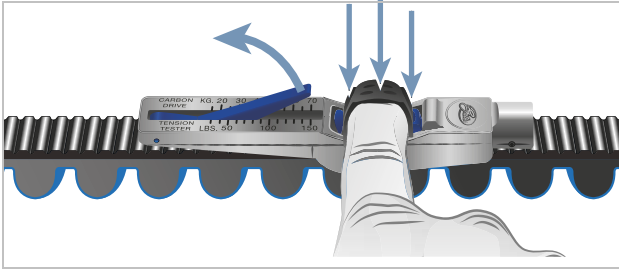

Figure 175: Pressing the check gauge down with one finger

- 4 Take reading where line A meets line B.

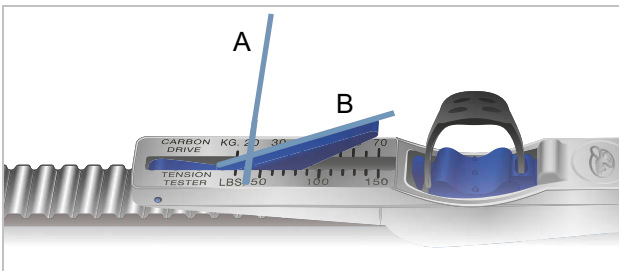

Figure 176: Example of a reading: 20 kg

- 5 Turn the pedal a quarter. Repeat measurement at least three times.
- 6 Convert value read from kg to pounds. The value is given in inches per pound.
Example: 20 kg = 44 inch = 44 lbs
- 7 Compare value with Table 44 Tension specification.
 - ⇒ If the value is higher than the specification, reduce belt tension.
 - ⇒ If the value is within the specified range, the belt tension has been correctly adjusted.
 - ⇒ If the value is lower than the specification, increase belt tension.

ECO tension tester

Not included in price

- 1 Attach the measuring stick on the belt.

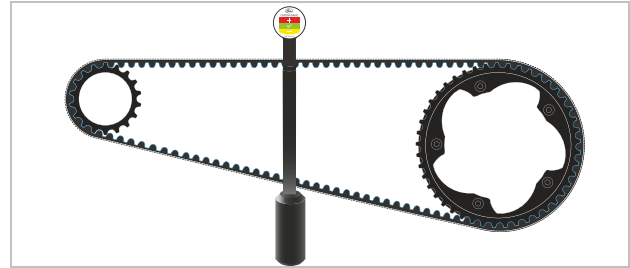

Figure 177: Attached measuring stick

- 2 Place the ruler on both belt sprockets.

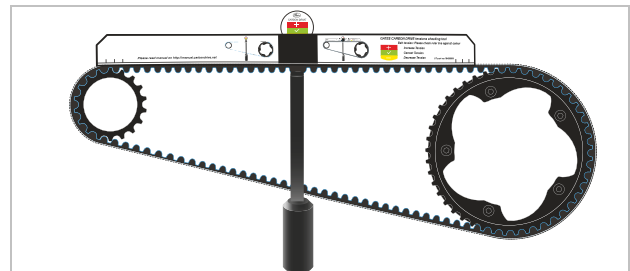

Figure 178: Ruler in place

- ⇒ Read tension on the tension indicator.

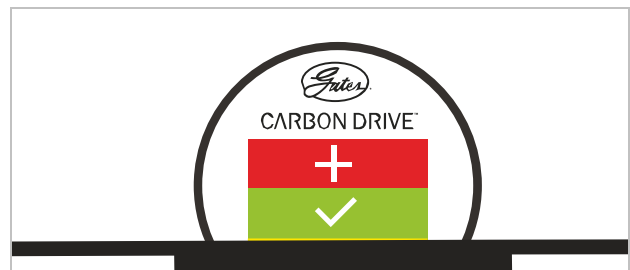

Figure 179: Example: On yellow along lower edge, so reduce belt tension slightly

- Red = increase belt tension
- Green = belt tension is set correctly
- Yellow = reduce belt tension

7.5.4 Checking the riding light

- 1 Check the cable connections on the headlight and rear light for damage and corrosion and ensure they are firmly in position.
 - ⇒ If the headlight or rear lights do not come on, take pedelec out of service. Contact specialist dealer.
- ⇒ If cable connections are damaged or corroded, or are not firmly in positioned. take pedelec out of service. Contact specialist dealer.
- 2 Switch light on.
- 3 Check that the headlight and rear light come on.
 - 4 Place pedelec 5 m from the wall.
 - 5 Stand the pedelec up straight. Hold the handlebars straight with both hands. Do not use the kickstand.

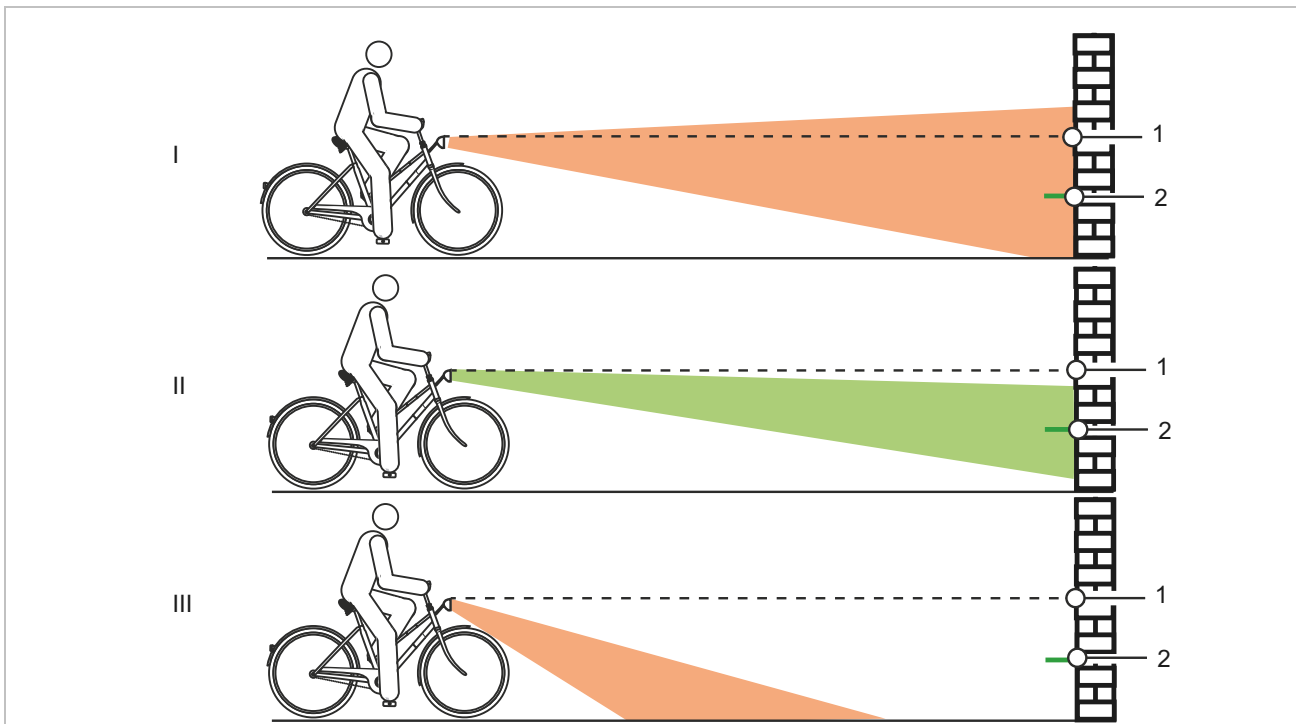

Figure 180: Light positioned too high (1), correctly (2) and too low (3)

- 6 Check the position of the light beam.
 - ⇒ If the light is positioned too high or too low, adjust riding light (see Section 6.4.16.1).

7.5.5 Checking the stem

- ▶ The stem and quick release system must be inspected at regular intervals. The specialist dealer should adjust them if they require adjustment.
- ▶ If the hexagon socket head screw is also loosened, the bearing clearance also needs to be adjusted. Medium-strength thread locker, such as Loctite blue, then needs to be applied to the loosened screws and the screws tightened as per specifications.
- ▶ Check metal contact surfaces on cone, stem clamping screw and fork steerer for corrosion.
- ⇒ Take pedelec out of service if there is any wear or signs of corrosion. Contact specialist dealer.

7.5.6 Checking the handlebars

- 1 Take hold of handlebars with both hands on the handles.
 - 2 Move handlebars up and down and press to tilt.
- ⇒ If the handlebars can move, contact your specialist dealer.
- 3 Place front wheel in position where it can't move sideways (e.g. in a bike stand).
 - 4 Hold handlebars firmly with both hands.
 - 5 Check if the handlebars are able to twist against the front wheel.
- ⇒ If the handlebars can move, contact your specialist dealer.

7.5.7 Checking the saddle

- 1 Hold saddle firmly.
 - 2 Check whether the saddle twists, tilts or can be pushed in one direction or other.
- ⇒ If the saddle twists, tilts or can be pushed in one direction or other, adjust the saddle (see Section 6.5.4).
 - ⇒ Contact your specialist dealer if the saddle cannot be fixed into position.

7.5.8 Checking the seat post

- 1 Take seat post out of the frame.
- 2 Check seat post for cracks and corrosion.
- 3 Reinsert seat post.

7.5.9 Checking the pedal

- 1 Hold pedal and try to move it sideways toward the inside or outside. In doing so, observe whether the crank arm or bearing move sideways.
- ⇒ If the pedal, crank arm or crank bearing moves sideways, fasten screw on the pedal crank rear.
- 2 Hold pedal and try to move it upwards and downwards vertically. In doing so, observe whether the pedal, crank arm or crank bearing moves vertically.
- ⇒ If the pedal, crank arm or crank bearing moves vertically, fasten screw.

7.5.10 Checking the gear shift

- 1 Check that all gear shift components are free of damage.
- 2 Contact your specialist dealer if components are damaged.
- 3 Place the pedelec on stand.
- 4 Turn the pedal crank clockwise.
- 5 Switch through all speeds.
- 6 Check that pedelec can switch through all speeds without making unusual noises.
- 7 Adjust the gear shift if gears cannot be changed correctly.

7.5.10.1 Checking the electric gear shift

- 1 Check the cable connections for damage and corrosion and ensure they are firmly in position.
- ⇒ If cable connections are loose, damaged or corroded, contact your specialist dealer.

7.5.10.2 Checking the mechanical gear shift

- 1 Change gear a number of times. Check whether the Bowden cables get stuck or they make scraping noises.
 - 2 Check the physical condition of the Bowden cables for visible damage and check to see if wire strands are broken.
- ⇒ Have defective Bowden cables replaced. Contact specialist dealer.

7.5.10.3 Checking derailleur gears

The chain is tensioned by the rear derailleur in pedelecs with derailleur gears.

- 1 Place the pedelec on stand.
 - 2 Check to see if the chain is sagging.
 - 3 Gently press the rear derailleur forwards to check whether it moves and whether it goes back into position by itself.
- ⇒ If the chain is sagging or the rear derailleur does not go back into position by itself, contact your specialist dealer.

- 4 Check that there is clearance between the chain tensioner and spokes.
- ⇒ If there is no clearance or the chain scrapes against the spokes or tyres, contact your specialist dealer.
- 5 Check that there is clearance between the chain or rear derailleur and spokes.
- ⇒ If there is no clearance or the chain scrapes against the spokes, contact your specialist dealer.

7.5.10.4 Checking the hub gear

In the case of pedelecs with a hub gear or back-pedal brake, the chain or the belt is tensioned by an eccentric bearing or movable fork end in the bottom bracket axle. Special tools and specialist knowledge are required to tension the chain. Contact specialist dealer.

- ✓ Remove the chain guard on pedelecs with a circumferential chain guard.

- 1 Place the pedelec on stand.
- 2 Check the chain or belt tension in three or four positions, turning the crank a full revolution.

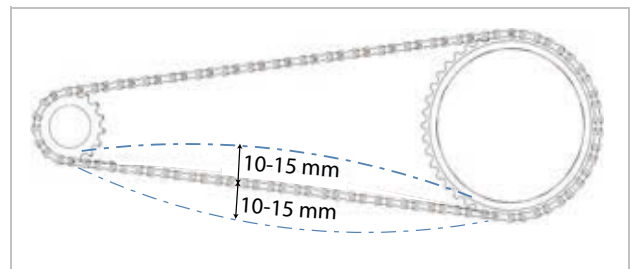

Figure 181: Checking the chain tension (example): 5 mm upwards, 10 mm downwards = 15 mm deviation

- 3 If the chain or the belt can be pushed more than 2 cm, the chain will need to be re-tensioned. Contact specialist dealer.
- ⇒ If the chain or belt can only be pushed up and down less than 1 cm, you will need to the chain or belt slightly. Contact specialist dealer.
- ⇒ The ideal chain and belt tension has been achieved if the chain can be pushed between a maximum of 10 and 15 mm in the middle between the sprocket and the toothed wheel. The crank must also turn without resistance.

7.5.10.5 Adjusting the ROHLOFF hub

Only applies to pedelecs with this equipment

- 1 Check whether shift cable tension is set in such a way that there is a perceptible play of around 5 mm when the shift handle is turned.
 - 2 Adjust the shift cable tension by turning the **tension adjuster**.
- ⇒ Unscrew the **tension adjuster** to increase the shift cable tension.
- ⇒ Tighten the **tension adjuster** to decrease the shift cable tension.



Figure 182: The tension adjuster on ROHLOFF hub versions with internal switch control is located on the tension counter support



Figure 183: The tension adjuster on ROHLOFF hub versions with external switch control is located on the cable box positioned on the left-hand side

- 3 If the marking and numbers on the shift handle do no longer coincide after the gear shift is adjusted, tighten one of the tension adjusters and screw out the other tension adjuster to the same extent.

7.5.10.6 Adjusting the cable-operated gear shift, dual-cable

Only applies to pedelecs with this equipment

- ▶ For a smooth gear shift, adjust the **adjusting sleeves** underneath the chain stay on the frame.
- ▶ The shift cable has around 1 mm play when it is pulled out gently.

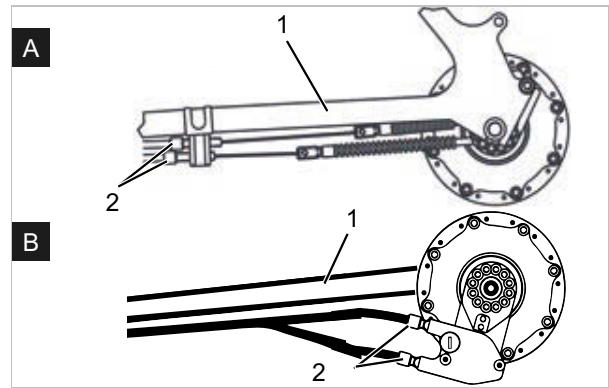

Figure 184: Adjusting sleeves (2) on two alternative versions (A and B) of a dual-cable, Bowden-cable-operated gear shift on the chain stay (1)

7.5.10.7 Adjusting the dual-cable, Bowden-cable-operated twist grip shifter

Only applies to pedelecs with this equipment

- ▶ For a smooth gear shift, adjust the **adjusting sleeves** on the shifter housing.
- ⇒ There is noticeable play of 2 to 5 mm (1/2 gear) when you turn the twist grip shifter.

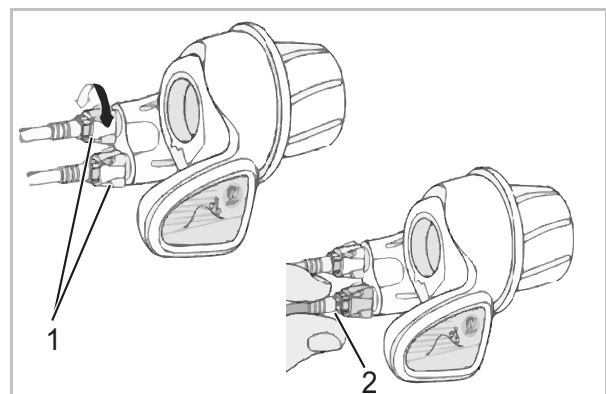

Figure 185: Twist grip shifter with adjusting sleeves (1) with play (2)

7.5.10.8 Checking kickstand stability

- 1 Place the pedelec on a slight elevation of 5 cm.
 - 2 Extend kickstand.
 - 3 Jolt pedelec to check stability.
- ⇒ If pedelec topples over, tighten screws or change height of the kickstand.

8 Inspection and maintenance

8.1 Initial inspection

After 200 km or 4 weeks after purchase

Vibrations produced while riding can cause screws and springs that were tightened during pedelec manufacture to settle or come loose.

- ▶ Arrange an appointment for the initial inspection directly when purchasing the pedelec.
- ▶ Have the initial inspection entered and stamped in the maintenance book.



- ▶ Carrying out the initial inspection, see Section 8.4.

8.2 Major inspection

Every six months

You must have your specialist dealer perform a major inspection every six months as a minimum. This is the only way to ensure that the pedelec remains safe and fully functional.

The tasks require technical expertise, special tools and special lubricants. The pedelec may become damaged if the stipulated major inspection and procedures are not carried out. This is why only specialist dealers may carry out the major inspection.

- ▶ Contact your specialist dealer and arrange an appointment.
- ▶ Enter and stamp major inspection tasks in the maintenance book.



- ▶ Perform major inspection.

8.3 Component-specific maintenance

High-quality components require extra maintenance. The tasks require technical expertise, special tools and special lubricants. The pedelec may become damaged if the stipulated maintenance intervals and procedures are not carried out. This is why only specialist dealers may carry out maintenance.

Correct maintenance on the fork not only guarantees a long service life, but also ensures optimal performance.

Each maintenance interval shows the maximum cycling hours for the required type of maintenance that the component manufacturer recommends.

- ▶ Optimise performance with shorter maintenance intervals, depending on use, terrain and environmental conditions.



- ▶ Enter any components with extra maintenance requirements with their corresponding maintenance intervals into the maintenance book when the pedelec is purchased.
- ▶ Inform the buyer of the additional maintenance schedule.
- ▶ Enter and stamp maintenance tasks in the maintenance book.

Inspection and maintenance intervals for suspension fork		
SR SUNTOUR suspension fork		
<input type="checkbox"/>	Maintenance 1	Every 50 hours
<input type="checkbox"/>	Maintenance 2	Every 100 hours
FOX suspension fork		
<input type="checkbox"/>	Maintenance	Every 125 hours or once a year
RockShox suspension fork		
<input type="checkbox"/>	Maintenance of stanchions for: Paragon™, XC™ 28, XC 30, 30™, Judy®, Recon™, Sektor™, 35™, Bluto™, REBA®, SID®, RS-1™, Revelation™, PIKE®, Lyrik™, Yari™, BoXXer	Every 50 hours
<input type="checkbox"/>	Maintenance of spring and damper unit for: Paragon, XC 28, XC 30,30 (2015 and earlier), Recon (2015 and earlier), Sektor (2015 and earlier), Bluto (2016 and earlier), Revelation (2017 and earlier), REBA (2016 and earlier), SID (2016 and earlier), RS-1 (2017 and earlier), BoXXer (2018 and earlier)	Every 100 hours
<input type="checkbox"/>	Maintenance of spring and damper unit for: 30 (2016+), Judy (2018+), Recon (2016+), Sektor (2016+), 35 (2020+), Revelation (2018+), Bluto (2017+), REBA (2017+), SID (2017+), RS-1 (2018+), PIKE (2014+), Lyrik (2016+), Yari (2016+), BoXXer (2019+)	Every 200 hours

Inspection and maintenance intervals for seat post		
by,schulz suspension seat post		
<input type="checkbox"/>	Maintenance	After the first 250 km; every 1500 km after that
Eightpins suspension seat post		
<input type="checkbox"/>	Clean wiper	20 hours
<input type="checkbox"/>	Clean slide bushing	40 hours
<input type="checkbox"/>	Replace slide bushing, wiper and felt strip	100 hours
<input type="checkbox"/>	Seal service for gas pressure spring	200 hours
FOX suspension seat post		
<input type="checkbox"/>	Maintenance	Every 125 hours or once a year
KINDSHOCK suspension seat post		
<input type="checkbox"/>	Maintenance	Every 6 months
RockShox dropper post		
<input type="checkbox"/>	Venting of remote control lever and/or maintenance of lower seat post unit for: Reverb™ A1/A2/B1, Reverb Stealth A1/A2/B1/C1...	Every 50 hours
<input type="checkbox"/>	Detach lower seat post, clean brass pins, check and replace if necessary and apply new grease for Reverb AXS™ A1...	Every 50 hours
<input type="checkbox"/>	Venting of remote control lever and/or maintenance of lower seat post unit for: Reverb B1, Reverb Stealth B1/C1..., Reverb AXS™ A1...	Every 200 hours
<input type="checkbox"/>	Complete maintenance of seat post for: Reverb A1/A2, Reverb Stealth A1/A2	Every 200 hours
<input type="checkbox"/>	Complete maintenance of seat post for: Reverb B1, Reverb Stealth B1	Every 400 hours
<input type="checkbox"/>	Complete maintenance of seat post for: Reverb AXS™ A1..., Reverb Stealth C1...	Every 600 hours
SR SUNTOUR suspension seat post		
<input type="checkbox"/>	Maintenance	Every 100 hours or once a year
All other suspension seat posts		
<input type="checkbox"/>	Maintenance	Every 100 hours

Inspection and maintenance intervals for rear frame damper		
RockShox rear frame damper		
<input type="checkbox"/>	Service air chamber assembly	Every 50 hours
<input type="checkbox"/>	Service damper and spring	Every 200 hours
FOX rear frame damper		
<input type="checkbox"/>	Maintenance	Every 125 hours or once a year
SR SUNTOUR rear frame damper		
<input type="checkbox"/>	Complete shock absorber service including damper reassembly and air seal replacement	Every 100 hours
Inspection and maintenance intervals for motor		
pinion C1.12, C1.9XR, C1.6		
<input type="checkbox"/>	<p>Maintenance 1 Check shift cables, outer sleeves, chains/belts, chainring and sprockets or belt sprockets for wear; replace if necessary. Check shift cables to ensure they are tensioned and move easily. Adjust or replace if necessary.</p> <p>Open shift box. Clean cable pulley, slide surfaces and gear box interior, epicyclic wheels and similar thoroughly and grease generously. Check and tighten all screw connections except gear box screws to ensure they are firmly in place and fasten with correct tightening torque.</p>	Every 500 km
<input type="checkbox"/>	Maintenance 2 Oil change	Every 10,000 km or once a year
pinion E1.12, E1.9		
<input type="checkbox"/>	Oil change	Every 10,000 km

Inspection and maintenance intervals for hub		
SHIMANO 11-speed hub		
<input type="checkbox"/>	Internal oil change and maintenance	1,000 km after start of use, then every 2 years or 2,000 km
All other SHIMANO gear hubs		
<input type="checkbox"/>	Lubricate internal components	Once a year or every 2,000 km
ROHLOFF Speedhub 500/14		
<input type="checkbox"/>	Clean cable box and grease cable drum interior	Every 500 km
<input type="checkbox"/>	Oil change	Every 5,000 km or at least once a year
Pinion		
<input type="checkbox"/>	<p>Maintenance 1 Check shift cables, outer sleeves, chains/belts and sprockets or belt sprockets for wear; replace if necessary. Check shift cables to ensure they are tensioned and move easily. Adjust or replace if necessary.</p> <p>Open shift box. Clean cable pulley, slide surfaces and gear box interior, epicyclic wheels and similar thoroughly and grease generously. Check and tighten all screw connections except gear box screws to ensure they are firmly in place and fasten with correct tightening torque.</p>	Every 500 km
<input type="checkbox"/>	Maintenance 2 Oil change	Every 10,000 km

 **WARNING**
Injury due to damaged brakes

Special tools and specialist knowledge are required to repair the brakes. Incorrect or unauthorised assembly can damage the brakes. This may lead to an accident with serious injuries.

- ▶ Only specialist dealers may carry out repairs on brakes.
- ▶ Only carry out work or changes, such as dismantling, sanding or painting, which are permitted and described in the brake operating instructions.

Injury to the eyes

Problems may arise if the settings are not made properly and you may sustain serious injuries as a result.

- ▶ Always wear safety glasses during Inspection and maintenance work.

 **CAUTION**
Crash and falling caused by unintentional activation

There is a risk of injury if the electric drive system is activated unintentionally.

- ▶ Remove the battery before inspection or maintenance.

Crash caused by material fatigue

If the service life of a component has expired, the component may suddenly fail. This may cause a crash with injuries.

- ▶ Have the specialist dealer carry out basic cleaning of the pedelec every six months, preferably at the same time as the required servicing work.

 **CAUTION**
Hazard for the environment due to toxic substances

The brake system contains toxic and environmentally harmful oils and lubricants. Such fluids will contaminate if they enter the sewers or groundwater.

- ▶ Dispose of lubricants and oils left over after repairs in an environmentally responsible way in accordance with statutory regulations.

Notice

The motor is maintenance-free and only qualified specialist personnel may open it.

- ▶ Never open the motor.

8.4 Carrying out initial inspection

Incorrectly fastened screws may come loose due to impact. The stem may no longer be firmly fixed in its position as a result. This will cause a crash with injuries.

- ▶ Check the handlebars and the stem quick release system are firmly in position after the first two hours of riding.

Vibrations produced while riding can cause screws and springs that were tightened during manufacture of the pedelec to settle or come loose.

- 1 Check quick release system is fixed in position.
- 2 Check all tightening torques of screws and screw connections.



8.5 Perform major inspection

Complying with these inspection and maintenance instructions is the only way to reduce wear on components, increase the operating hours and guarantee safety.

Diagnosis and documentation of current status

Components	Fre- quency	Description			Criteria		Measures if rejected
		Inspection	Tests	Maintenance	Accept- ance	Rejection	
Chassis							
Frame	Once a month	Dirt	...	Section 7.3.4	O.K.	Dirt	Cleaning
	6 months	Maintenance	...	Section 7.4.1	O.K.	Untreated	Wax
	6 months	Check for damage – fracture, scratches	Section 8.6.1	...	O.K.	Damage detected	Take pedelec out of service, new frame as specified in parts list
Carbon frame (optional)	Once a month	Dirt	Section 7.3.4	...	O.K.	Dirt	Cleaning
	6 months	Maintenance	...	Section 7.4.1	O.K.	No wax	Wax
	6 months	Damage to paintwork	Section 8.6.1.1	...	O.K.	Damage to paintwork	Apply paint
	6 months	Damage from impact	Section 8.6.1.1	...	O.K.	Damage from impact	Take pedelec out of service, new frame as specified in parts list
ROCKSHOX Rear frame damper (optional)	6 months	Check for damage, corrosion, fracture	See ROCKSHOX component maintenance instructions	Maintenance as specified by manufacturer Air chamber assembly group, damper and spring	O.K.	Damage detected	New rear frame damper as specified in parts list
FOX Rear frame damper (optional)	6 months	Check for damage, corrosion, fracture	...	Send to FOX	O.K.	Damage detected	New rear frame damper as specified in parts list
SR SUNTOUR Rear frame damper (optional)	6 months	Check for damage, corrosion, fracture	See SR SUNTOUR component maintenance instructions	Maintenance as specified by manufacturer Complete shock absorber service including damper reassembly and air seal replacement	O.K.	Damage detected	New rear frame damper as specified in parts list
Steering system							
Handlebars	Once a month	Cleaning	...	Section 7.3.6	O.K.	Dirt	Cleaning
	6 months	Wax	...	Section 7.4.7	O.K.	Untreated	Wax
	6 months	Check mount fastening	Section 7.5.6	...	O.K.	Loose, rust	Tighten screws; new handlebars as specified in parts list if necessary



Components	Fre- quency	Description			Criteria		Measures if rejected
		Inspection	Tests	Maintenance	Accept- ance	Rejection	
Stem	Once a month	Cleaning	...	Section 7.3.5	O.K.	Dirt	Cleaning
	6 months	Wax	...	Section 7.4.6	O.K.	Untreated	Wax
	6 months	Check mount fas- tening	Section 7.5.5 and Section 8.6.4	...	O.K.	Loose, rust	Retighten screws; new stem as specified in parts list if neces- sary
Handles	Once a month	Cleaning	...	Section 7.3.7	O.K.	Dirt	Cleaning
	Once a month	Care	Section 7.4.8	...	O.K.	Untreated	Talcum powder
	before each ride	Wear; check if fas- tened securely	Section 7.1.11	...	O.K.	Missing, wob- bles	Retighten screws, new handles and cov- erings as specified in parts list
Steering head- set	6 months	Clean and check for damage	...	Clean, lubricate and adjust	O.K.	Unclean	Clean and lubricate
Fork (rigid)	6 months	Check for damage, corrosion, fracture	...	Dismount, check, lubricate, refit	O.K.	Damage detected	New fork as specified in the parts list
Carbon fork (optional)	6 months	Check for damage, corrosion, fracture	...	Maintenance as specified by manufacturer Lubrication, oil change as specified by manufacturer	O.K.	Damage detected	New fork as specified in the parts list
SR SUNTOUR suspension fork (optional)	6 months	Check for damage, corrosion, fracture	...	Maintenance as specified by manufacturer Lubrication, oil change as specified by manufacturer	O.K.	Damage detected	New fork as specified in the parts list
FOX suspen- sion fork (optional)	6 months	Check for damage, corrosion, fracture	...	Send to FOX	O.K.	Damage detected	New rear frame damper as specified in parts list
RockShox sus- pension fork (optional)	6 months	Check for damage, corrosion, fracture	...	Maintenance as specified by manufacturer Lubrication, oil change as specified by manufacturer	O.K.	Damage detected	New fork as specified in the parts list
Spinner sus- pension fork (optional)	6 months	Check for damage, corrosion, fracture	...	Maintenance as specified by manufacturer Lubrication, oil change as specified by manufacturer	O.K.	Damage detected	New fork as specified in the parts list



Components	Fre-quency	Description			Criteria		Measures if rejected
		Inspection	Tests	Maintenance	Accept-ance	Rejection	
Wheel							
Wheel	Before each ride	Concentricity	Section 7.1.7	...	O.K.	Not straight	Re-mount wheel
	6 months	Assembly	Section 7.5.1	...	O.K.	Loose	Adjust quick release
Tyres	Once a month	Cleaning	Section 7.3.10	...	O.K.	Dirt	Cleaning
	Once a week	Tyre pressure	Section 7.5.1.1	...	O.K.	Tyre pressure too low/too high	Adjust tyre pressure
	10 days	Wear	Section 7.3.10	...	O.K.	Worn profile	New tyre as specified in the parts list
Rims	6 months	Wax	...	Section 7.4.10	O.K.	Untreated	Wax
	6 months	Wear	Section 7.5.1.3	...	O.K.	Defective rim	New rim as specified in the parts list
	Once a month	Wear on brake surface	Section 7.5.2.4	...	O.K.	Worn brake surface	New rim as specified in the parts list
Spokes	Once a month	Cleaning	...	Section 7.3.11	O.K.	Dirt	Cleaning
	3 months	Check tension	Section 7.5.1.3	...	O.K.	Loose, tension varies	Re-tension spokes or new spokes as specified in parts list
	6 months	Check rim hooks	Section 7.5.1.3	...	O.K.	Twisted rim hooks	New rim as specified in the parts list
Spoke nipples	Once a month	Cleaning	...	Section 7.3.11	O.K.	Dirt	Cleaning
	Once a month	Wax	...	Section 7.4.13	O.K.	Untreated	Wax
Nipple holes	6 months	Check for cracks	Section 7.5.1.4	...	O.K.	Cracks	New rim as specified in the parts list
Nipple well	Once a year	Check for cracks	Section 7.5.1.5	...	O.K.	Cracks	New rim as specified in the parts list
Hub	Once a month	Cleaning	...	Section 7.3.12	O.K.	Dirt	Cleaning
	Once a month	Care	...	Section 7.4.12	O.K.	Untreated	Treat
Hub with cone bearing (optional)	Once a month	Cleaning	...	Section 7.3.12	O.K.	Dirt	Cleaning
	Once a month	Care	...	Section 7.4.12	O.K.	Untreated	Treat
	6 months	Check mount fastening	O.K.	Loose, rust	Retighten screws; new handlebars as specified in parts list if necessary
	Once a year	Adjust	...		O.K.	Not adjusted	New position



Components	Fre- quency	Description			Criteria		Measures if rejected
		Inspection	Tests	Maintenance	Accept- ance	Rejection	
Hub gear (optional)	Once a month	Cleaning	...	Section 7.3.12	O.K.	Dirt	Cleaning
	Once a month	Care	...	Section 7.4.12	O.K.	Untreated	Treat
	6 months	Check mount fas- tening	O.K.	Loose, rust	Retighten screws; new handlebars as specified in parts list if necessary
	6 months	Functional check	Section 7.5.10.4	...		incorrect switching	Readjust hub
Saddle and seat post							
Saddle	Once a month	Cleaning		Section 7.3.9	O.K.	Dirt	Cleaning
	6 months	Check mount fas- tening	Section 7.5.7	...	O.K.	Loose	Retighten screws
Leather saddle (optional)	Once a month	Cleaning	...	Section 7.3.9.1	O.K.	Dirt	Cleaning
	6 months	Care	...	Section 7.4.11	O.K.	Untreated	Leather wax
	6 months	Check mount fas- tening	Section 7.5.7	...	O.K.	Loose	Retighten screws
Seat post	Once a month	Cleaning	...	Section 7.3.8	O.K.	Dirt	Cleaning
	6 months	Care	...		O.K.	Untreated	Leather wax
	6 months	Complete clean, check fastening and paint protection film	...	Section 8.6.8	O.K.	Loose	Tighten screws, new paint protection film
Carbon seat post (optional)	Once a month	Cleaning	...	Section 7.3.8	O.K.	Dirt	Cleaning
	6 months	Care	...	Section 7.4.9.2	O.K.	Untreated	Assembly paste
	6 months	Complete clean, check fastening and paint protection film	...	Section 8.6.8.1	O.K.	Loose	Tighten screws, apply new paint protection film; new seat post as specified in parts list if damaged
Suspension seat post (optional)	Once a month	Cleaning	O.K.	Dirt	Cleaning
	6 months	Care	...	Section 7.4.9.1	O.K.	Untreated	Oils
	100 hours or 6 months	Complete clean, check fastening and paint protection film	Section 8.6.8	...	O.K.	Loose	Tighten screws, new paint protection film
by.schulz sus- pension seat post (optional)	After the first 250 km; every 1500 km after that	Complete clean, check fastening and paint protection film, lubricate	Section 8.6.8.2	...	O.K.	Loose	Tighten screws, apply new paint protection film; new seat post as specified in parts list if damaged
SR SUNTOUR suspension seat post	Every 100 hours or once a year	Complete clean, check fastening and paint protection film, lubricate	Section 8.6.8.3	...	O.K.	Loose	Tighten screws, apply new paint protection film; new seat post as specified in parts list if damaged



Components	Fre- quency	Description			Criteria		Measures if rejected
		Inspection	Tests	Maintenance	Accept- ance	Rejection	
EIGHTPINS NGS2 Suspension seat post	20 hours	Refill oil	...	Section 7.4.19	O.K.	No oil	Refill oil
	20 hours	Clean wiper			O.K.	Dirt	Cleaning
	40 hours	Clean slide bushing			O.K.	Dirt	Cleaning
	100 hours	Replace slide bushing, wiper and felt strip			O.K.	No replacement	Replace
	200 hours	Seal service for gas pressure spring			O.K.	No service	Carry out the service
EIGHTPINS H01 Suspension seat post	20 hours	Refill oil	...	Section 7.4.19	O.K.	No oil	Refill oil
	20 hours	Clean wiper			O.K.	Dirt	Cleaning
	40 hours	Clean slide bushing			O.K.	Dirt	Cleaning
	100 hours	Replace slide bushing, wiper and felt strip			O.K.	No replacement	Replace
	200 hours	Seal service for gas pressure spring			O.K.	No service	Carry out the service
RockShox dropper post	50 hours	Venting	...	See manufacturer	O.K.		
	50 hours	Cleaning	...	See manufacturer	O.K.		
	200 hours	Venting	...	See manufacturer	O.K.		
	200 hours	Complete maintenance	...	See manufacturer	O.K.		
	400 hours	Complete maintenance	...	See manufacturer	O.K.		
	600 hours	Complete maintenance	...	See manufacturer	O.K.		
FOX suspension seat post	Every 125 hours or once a year	Complete maintenance	See manufacturer	At the manufacturer FOX	
Safety guards							
Belt or chain guards	6 months	Attachment	Check mount fastening	...	O.K.	Loose	Retighten screws
Guard	6 months	Attachment	Check mount fastening	...	O.K.	Loose	Retighten screws
Motor cover	6 months	Attachment	Check mount fastening	...	O.K.	Loose	Retighten screws
Brake system							
Handbrake	6 months	Attachment	Check mount fastening	...	O.K.	Loose	Retighten screws
Brake fluid	6 months	Check fluid level	Depending on time of year	...	O.K.	Too little	Top up brake fluid; take Pedelec out of service if damaged; new brake hoses
Brake linings	6 months	Brake linings, brake discs and rims	Check for damage	...	O.K.	Damage detected	New brake linings, brake discs and rims



Components	Fre- quency	Description			Criteria		Measures if rejected
		Inspection	Tests	Maintenance	Accept- ance	Rejection	
Back-pedal brake braking armature	6 months	Attachment	Check mount fastening	...	O.K.	Loose	Retighten screws
Brake system	6 months	Attachment	Check mount fastening	...	O.K.	Loose	Retighten screws
Lighting system							
Light cabling	6 months	Connections, cor- rect wiring	Check	...	O.K.	Cable defec- tive, no light	New cabling
Rear light	6 months	Side light	Functional check	...	O.K.	No constant light	New rear light as specified in parts list; replace if necessary
Front light	6 months	Side light, daytime riding light	Functional check	...	O.K.	No constant light	New front light as specified in parts list; replace if necessary
Reflectors	6 months	All complete, state, fastening	Check	...	O.K.	Damaged or not all com- plete	New reflectors
Drive/gear shift							
Chain/cassette/ sprocket/chain- ring	6 months	Check for damage	Check for dam- age	...	O.K.	Damage	Refasten if necessary or replace as speci- fied in parts list
Chain guard/ spoke guard	6 months	Check for damage	Check for dam- age	...	O.K.	Damage	Replace as specified in parts list
Bottom bracket axle/crank	6 months	Check mount fas- tening	Check mount fastening	...	O.K.	Loose	Retighten screws
Pedals	6 months	Check mount fas- tening	Check mount fastening	...	O.K.	Loose	Retighten screws
Shifter	6 months	Check mount fas- tening	Check mount fastening	...	O.K.	Loose	Retighten screws
Shift cables	6 months	Check for damage	Check for dam- age	...	O.K.	Loose and defective	Adjust shift cables; new shift cables if necessary
Front derailleur	6 months	Check for damage	Check for dam- age	...	O.K.	Gear shift diffi- cult or not pos- sible	Adjust
Rear derailleur	6 months	Check for damage	Check for dam- age	...	O.K.	Gear shift diffi- cult or not pos- sible	Adjust
Electric drive system							
On-board com- puter	6 months	Check for damage	Check for dam- age	...	O.K.	No screen, defective screen display	Restart, test battery, new software or new on-board computer, decommissioning,
Control panel	6 months	Check control panel for damage	Check for dam- age	...	O.K.	No response	Restart; contact con- trol panel manufac- turer, new control panel
Tachometer	6 months	Calibration	Speed meas- urement	...	O.K.	Pedelec travel- ling 10% too fast/slow	Take pedelec out of service until the source of the error is found
Cabling	6 months	Visual inspection	Visual inspec- tion	...	O.K.	Failure in sys- tem, damage, kinked cables	New cabling



Components	Frequency	Description			Criteria		Measures if rejected
		Inspection	Tests	Maintenance	Acceptance	Rejection	
Rechargeable battery	6 months	First examination	See Section on Assembly	...	O.K.	Error message	Contact battery manufacturer; take out of service, new battery
Battery mount	6 months	Firmly in position, lock, contacts	Check mount fastening	...	O.K.	Loose; lock doesn't close, no contacts	New battery mount
Motor	6 months	Visual inspection and mount	Check mount fastening	...	O.K.	Damage, loose	Refasten motor, contact motor manufacturer, new motor; take out of service
Software	6 months	Check version	Check software version	...	In latest version	Not latest version	Import update
Miscellaneous							
Pannier rack	Before each ride	Stability	Section 7.1.5	...	O.K.	Loose	Firm
	Once a month	Dirt	...	Section 7.3.4	O.K.	Dirt	Cleaning
	6 months	Maintenance	...	Section 7.4.3	O.K.	Untreated	Wax
	6 months	Check fastening and paint protection film	Section 8.5.2	...	O.K.	Loose	Tighten screws, new paint protection film
Kickstands	Once a month	Dirt	...	Section 7.3.4	O.K.	Dirt	Cleaning
	6 months	Maintenance	...	Section 7.4.5	O.K.	Untreated	Wax
	6 months	Attachment	Section 7.5.10.8	...	O.K.	Loose	Retighten screws
	6 months	Stability	Section 7.5.10.8	...	O.K.	Tips over	Change kickstand height
Bell	Before each ride	Sound	Functional check, Section 7.1.10.	...	O.K.	No ring, too quiet, missing	New bell as specified in the parts list
Attachments (optional)	6 months	Attachment	Check mount fastening	...	O.K.	Loose	Retighten screws

Technical inspection, checking safety, test ride

Components	Description		Criteria		Measures if rejected
	Assembly/inspection	Tests	Acceptance	Rejection	
Brake system	6 months	Functional check	O.K.	No full braking; braking distance too long	Locate defective part in brake system and correct
Gear shift under operating load	6 months	Functional check	O.K.	Problems when shifting gear	Readjust gear shift
Suspension components (fork, shock absorber, seat post)	6 months	Functional check	O.K.	Suspension too deep or no longer exists	Locate defective component and correct
Electric drive system	6 months	Functional check	O.K.	Loose connection, problems when riding, accelerate	Locate faulty component in electric drive and remedy
Lighting system	6 months	Functional check	O.K.	No continuous light, not bright enough	Locate defective part in lighting system and correct
Test ride	6 months	Functional check	No strange noises	Strange noises	Locate source of noise and correct



8.5.1 Inspect frame

- 1 Check frame for cracks, warping and damage to the paintwork.
- ⇒ If there are any cracks, warping or damage to the paintwork, remove the pedelec from service. New frame as specified in the parts list.

8.5.1.1 Inspecting the carbon frame

You need to distinguish between scratches on the paintwork and impacts if the carbon frame paintwork is damaged.

- ▶ Ask customer what caused the damage.
- ▶ Examine damage with a magnifying glass to see if fibres are permanently damaged or delamination has taken place.

8.5.2 Inspecting the pannier rack

Scratches, cracks and breaks may appear on the pannier rack caused by the panniers and cargo boxes.

- 1 Examine pannier rack for scratches, cracks and breaks.
- ⇒ Replace damaged pannier racks.
- ⇒ If the paint protection film is missing or has worn away, affix a new paint protection film.

8.5.3 Inspecting and maintaining the rear frame damper

Only applies to pedelecs with this equipment



WARNING

Injury due to explosion

The air chamber is pressurised. If the air system is serviced in a rear frame damper, it can explode and cause serious injury.

- ▶ Wear safety goggles, protective gloves and safety clothing when assembling or carrying out maintenance on the bicycle.
- ▶ Release the air for the air chambers. Detach all air insert fitments.
- ▶ Never service or dismantle a rear frame damper if it has not completely rebounded.

Intoxication from suspension oil

Suspension oil is poisonous to the touch, irritates respiratory tracts and causes cancer, sterility and mutation in germ cells.

- ▶ Always wear safety goggles and nitrile gloves when carrying suspension oil.
- ▶ Never perform inspection or maintenance when you are pregnant.
- ▶ Use an oil catchment tray under the section where the rear frame damper is being serviced.

Intoxication from lubrication oil

The lubrication oil for Eightpins seat posts is toxic if touched or inhaled.

- ▶ Always wear safety goggles and nitrile gloves when working with lubrication oil.
- ▶ Lubricate seat post in the open air or in a well-ventilated room only.
- ▶ Avoid skin coming into contact with lubrication oil. Wear nitrile gloves when lubricating, cleaning and maintaining the vehicle.
- ▶ Use an oil catchment tray under the section where the seat post is serviced.

CAUTION
Hazard for the environment due to toxic substances

The rear frame damper contains toxic and environmentally harmful oils and lubricants. Such fluids will contaminate if they enter the sewers or groundwater.

- ▶ Dispose of lubricants and oils left over after repairs in an environmentally responsible way in accordance with statutory regulations.

- 1 Dismantle the rear frame damper.
 - 2 Clean and inspect its interior and exterior.
 - 3 Recondition air springs.
 - 4 Replace airtight seals on air springs.
 - 5 Change oil.
- ⇒ Replace dust wipers.

8.5.4 Inspecting the gear hub

8.5.4.1 Adjusting the hub with cone bearing

In the case of hubs with a cone bearing, the bearing shell fixed in the hub cone body rotates with its larger ball bearing surfaces around the inner bearing cone resting against the fork end. The outer bearing shell rotating around the stationary bearing cone is subject to considerably more evenly distributed loads thanks to its larger ball running surface.

- 1 Attach a small, red colour marking on the lock nut.
 - 2 Turn the wheel axle 40° to 90° every 1,000 to 2,000 km.
- ⇒ The bearing cone is subject to evenly distributed loads.

8.5.5 Inspecting the stem

Incorrectly fastened screws may come loose due to impact. The stem may no longer be firmly fixed in its position as a result. This will cause a crash with injuries.

- ▶ Check the handlebars and the stem's quick release are firmly in position.

8.5.6 Inspect and grease steering headset

- 1 Remove fork.
- 2 Clean steering headset. If it is very dirty, flush the bearing with cleaning agents such as WD-40 or Karamba.
- 3 Check steering headset for damage.
 - ⇒ If the steering headset is damaged, replace steering headset as specified in the parts list.
- 4 Grease steering headset and bearing seat with highly viscous, water-repellent grease (e.g. Dura Ace special grease by SHIMANO).
- 5 Re-fit fork with steering headset as per fork instructions.



8.5.7 Inspecting the axle with quick release

CAUTION

Crash caused by unfastened quick release

A faulty or incorrectly installed quick release may become caught in the brake disc and block the wheel. This will cause a crash.

- ▶ Install the front wheel quick release lever on the opposite side to the brake disc.

Crash caused by faulty or incorrectly installed quick release

The brake disc becomes very hot during operation. Parts of the quick release may become damaged as a result. The quick release comes loose. This will cause a crash with injuries.

- ▶ The front wheel quick release lever and the brake disc must be situated on opposite sides.

Crash caused by incorrectly set clamping force

Excessively high clamping force will damage the quick release and cause it to lose its function.

Insufficient clamping force will cause a detrimental transmission of force. The suspension fork or the frame may break. This will cause a crash with serious injuries.

- ▶ Never fasten a quick release using a tool (e.g. hammer or pliers).
- ▶ Only use the clamping lever with the specified set clamping force.

- 1 Undo quick release.
- 2 Fasten quick release.
- 3 Check the position and clamping force of the quick release lever.

- ⇒ The quick release lever is flush with the lower housing.
- ⇒ You should be able to see slight impression on the palm of your hand when you close the quick release lever.



Figure 186: Adjusting the quick release clamping force

- 4 Use a 4 mm hexagon socket spanner to adjust the clamping lever clamping force if required.
- 5 Check the quick release lever position and clamping force again.

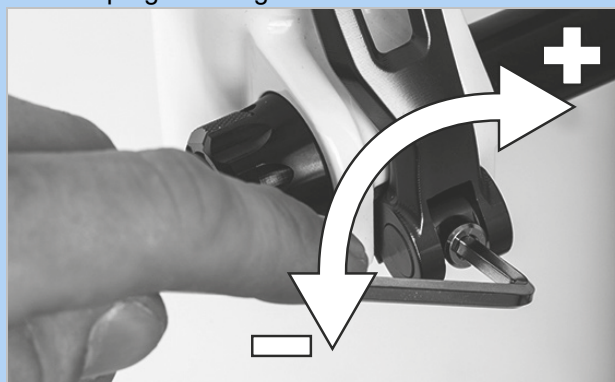

Figure 187: Adjusting the quick release clamping force



8.5.8 Inspecting the fork

WARNING

Injury due to explosion

The air chamber is pressurised. When the air system in a faulty suspension fork is maintained, it may explode and cause serious injury.

- ▶ Wear safety goggles, protective gloves and safety clothing when assembling or carrying out maintenance on the bicycle.
- ▶ Release the air for the air chambers. Detach all air insert fitments.
- ▶ Never service or dismantle a suspension fork if it has not completely rebounded.

CAUTION

Hazard for the environment due to toxic substances

The suspension fork contains toxic and environmentally harmful oils and lubricants. Such fluids will contaminate if they enter the sewers or groundwater.

- ▶ Dispose of lubricants and oils left over after repairs in an environmentally responsible way in accordance with statutory regulations.

- 1 Remove fork.
- 2 Check fork for cracks, warping and damage to the paintwork.
 - ⇒ If there are any cracks, warping or damage to the paintwork, remove the pedelec from service. New fork as specified in the parts list.
- 3 Clean inside and exterior.
- 4 Grease fork.
- 5 Install fork.

8.5.8.1 Inspecting the carbon suspension fork

Only applies to pedelecs with this equipment

- 1 Remove fork.
- 2 Check fork for cracks, warping and damage to the paintwork.
- 3 You need to distinguish between scratches on the paintwork and impacts if the carbon suspension fork paintwork is damaged.
 - ▶ Ask customer what caused the damage.
 - ▶ Examine damage with a magnifying glass to see if fibres are permanently damaged or delamination has taken place.

8.5.8.2 Inspecting the suspension fork

Only applies to pedelecs with this equipment

- 1 Remove fork.
- 2 Check fork for cracks, warping and damage to the paintwork.
 - ⇒ If there are any cracks, warping or damage to the paintwork, remove the pedelec from service. New fork as specified in the parts list.
- 3 Dismantle suspension fork.
- 4 Lubricate dust seals and slide bushings.
- 5 Check torques.
- 6 Clean inside and exterior.
- 7 Grease fork.
- 8 Install fork.
- 9 Adjust suspension fork (see Section 6.3.14).



8.5.9 Inspecting the seat post



WARNING

Intoxication from lubrication oil

The lubrication oil for Eightpins seat posts is toxic if touched or inhaled.

- ▶ Always wear safety goggles and nitrile gloves when working with lubrication oil.
- ▶ Lubricate seat post in the open air or in a well-ventilated room only.
- ▶ Avoid skin coming into contact with lubrication oil. Wear nitrile gloves when lubricating, cleaning and maintaining the vehicle.
- ▶ Use an oil catchment tray under the section where the seat post is serviced.

- 1 Remove seat post from the frame.
- 2 Clean seat post on the inside and outside.
- 3 Examine seat post rack for scratches, cracks and fractures.
 - ⇒ Replace damaged seat post as specified in the parts list.
- 4 Fit seat post as per height specifications in the pedevec pass.

8.5.9.1 Inspecting the carbon seat post

Only applies to pedevecs with this equipment

You need to distinguish between impacts and scratches on the paintwork if the carbon seat post paintwork is damaged.

- ▶ Ask customer what caused the damage.
- ▶ Examine damage with a magnifying glass to see if fibres are permanently damaged or delamination has taken place.

8.5.9.2 Inspecting and greasing BY.SCHULZ suspension seat post

Only applies to pedevecs with this equipment

- 1 Remove seat post from the frame.
- 2 Remove safety and protective cover.
- 3 Clean seat post on the inside and outside.
- 4 Examine seat post rack for scratches, cracks and fractures.
 - ⇒ Replace damaged seat post as specified in the parts list.
- 5 Lubricate screws in the parallel suspension.
- 6 Reinsert seat post as per height specifications in the pedevec pass. Check screws for correct tightening torques.

<input type="checkbox"/>	Torques G1 M8 seat clamp screw M5 fixing grub screws	20 ... 24 Nm 3 Nm
--------------------------	---	----------------------

<input type="checkbox"/>	Torque G2 M6 seat clamp screw M5 fixing grub screws	12 ... 14 Nm 3 Nm
--------------------------	--	----------------------

- 7 Put on safety and protective cover.



8.5.9.3 Inspecting and greasing RS SUNTOUR suspension seat post

Only applies to pedelecs with this equipment

- 1 Remove seat post from the frame.
- 2 Remove safety and protective cover.
- 3 Examine seat post rack for scratches, cracks and fractures.
 - ⇒ Replace damaged seat post as specified in the parts list.
 - ⇒ If the paint protection film protecting a child seat is missing or has worn away, affix a new paint protection film.
- 4 Undo preload adjuster and take out steel suspension.
- 5 Clean seat post on inside and outside.
- 6 Grease seat post on inside with SR SUNTOUR grease no. 9170-001.
- 7 Lubricate pressure roller with bicycle chain oil.
 - ▶ Lubricate articulated joints in parallel suspension with bike chain oil.



Figure 188: SR SUNTOUR suspension seat post lubrication points

- 8 Reinsert seat post as per height specifications in the pedelec pass.
- 9 Check screws for correct tightening torques.

<input type="checkbox"/>	SR SUNTOUR suspension seat post torques Seat clamp screw M5 fixing grub screws	15–18 Nm 3 Nm
--------------------------	---	------------------

- 10 Put on safety and protective cover.

8.5.10 Torque

Model	Torque	Tool
Axle		
Conventional axle nut	35 ... 40 Nm*	15 mm spanner
SR SUNTOUR screw-on axle 12AH2 Axle Securing screw	8 ... 10 Nm 5 ... 6 Nm	6 mm hex bit 5 mm hex bit
SR SUNTOUR screw-on axle 15AH2 Axle Securing screw	8 ... 10 Nm 5 ... 6 Nm	6 mm hex bit 5 mm hex bit
Intend. Edge Axle Securing screw	3 ... 5 Nm 10 Nm	M6
Rechargeable battery		
BOSCH PowerPack 400/500/600/800 4 × attachment screws for casing base locking mechanism 2 × attachment screws for cover 2 × attachment screws for cover 2 × attachment screws for bracket on cable side 1 × attachment screw for bracket on cable side 2 × attachment screws for bracket on lock side 1 × attachment screws for bracket on lock side	5 Nm 2 Nm 2 Nm 1.3 Nm 5 Nm 5 Nm 1 Nm	Torx® T25, M5 × 20 M3.5 × 12 M3.5 × 12 (pointed) Torx® T15 Torx® T25, M5 × 20 Torx® T25 Torx® T15, M3.5 × 12
Display		
FIT Comfort/Compact bracket Attachment screw	0.5 Nm	Hex key, 2.5 mm
FIT Comfort/Compact Mounting bracket	0.8 Nm	Torx® T20
On-board computer		
FIT Remote Basic Mounting bracket	0.8 Nm	Torx® T20
FIT Remote Display Mounting bracket	0.8 Nm	Torx® T20
BOSCH Intuvia 100 bracket  Attachment screw 1, M3 × 22 Attachment screw 2, M3 × 14	1 Nm 1 Nm	3 mm hex bit 3 mm hex bit
BOSCH System Controller Attachment screw	0.5 Nm	Torx® T10

BOSCH Mini Remote Attachment screw	0.4 Nm (not 0.6 Nm, as written on mini-remote)	3 mm hex bit
SHIMANO SC-E5003 Attachment screw	0.8 Nm	3 mm hex bit
Brake linings		
SHIMANO Circlip	2 ... 4 Nm	Hex key, 3 mm Slotted-head screwdriver
TEKTRO for hydraulic disc brake system Attachment screws	3 ... 5 Nm	Hex key, 3 mm
Brake cable		
SHIMANO Connecting screw, handbrake	5 ... 7 Nm	Screw wrench, 8 mm
SHIMANO Connecting screw, brake calliper, version for banjo type connection	5 ... 7 Nm 8 ... 10 Nm	Hex key, 3 mm Hex key, 4 mm
SHIMANO Connecting screw for brake calliper, straight version	5 ... 7 Nm	Hex key, 3 mm
SHIMANO for racing bicycles Connecting screw for cable sleeve	5 ... 7 Nm	Screw wrench, 8 mm
TEKTRO for hydraulic disc brake system Bleed valve on brake calliper	4 ... 6 Nm	#
TEKTRO for hydraulic disc brake system Lock screw for the fluid reservoir on the handbrake	2 ... 4 Nm	Torx® T15
Brake calliper		
SHIMANO Adapter attachment screw and brake calliper attachment screw, version with IS brake mount	6 ... 8 Nm	...
SHIMANO Brake calliper attachment screw, post-mount version	6 ... 8 Nm	...
TEKTRO for hydraulic disc brake system Adapter attachment screws	6 ... 8 Nm	#
TEKTRO for hydraulic disc brake system Brake calliper attachment screw	6 ... 8 Nm	Hex key, 5 mm
Brake disc		
SHIMANO for centre lock type Quick release attachment screw	40 ... 50 Nm	TL-LR15 TL-FC36/TL-LR11 Adjustable spanner
SHIMANO for centre lock type Attachment screw, nut version	40 ... 50 Nm	TL-LR10 Screw wrench

SHIMANO for 5-hole version Attachment screws	2 ... 4 Nm	Star bit [no. 25]
SHIMANO for 6-hole version Attachment screws	2 ... 4 Nm	Star bit [no. 25]
TEKTRO for hydraulic disc brake system Attachment screws	4 ... 6 Nm	Torx® T25
Cantilever brake		
SHIMANO Brake calliper attachment screw	5 ... 7 Nm	Hex key, 5 mm
SHIMANO Attachment screw for brake shoe	8 ... 9 Nm	Hex key, 5 mm Screw wrench, 10 mm
SHIMANO Bowden cable attachment screw	6 ... 8 Nm	Hex key, 5 mm
Dual pivot rim brake		
SHIMANO Attachment screw	8 ... 10 Nm	Hex key, 5 mm
SHIMANO, models with nut Attachment screw	8 ... 10 Nm	Screw wrench, 10 mm
SHIMANO Attachment screw for brake shoe	5 ... 7 Nm	Hex key, 4 mm
SHIMANO, left side Attachment screw for brake cable	6 ... 8 Nm	Hex key, 5 mm
SHIMANO, right side Attachment screw for brake cable	1 ... 1.5 Nm	Hex key, 2 mm
Seat post remote control		
Eightpins Attachment screw Bowden cable fastener	2.5 Nm 5 Nm	4 mm hex bit 3 mm hex bit
Freewheel		
SHIMANO	35 Nm	Multiple freewheel tool TL-FW3
Suspension fork		
Intend Edge Double bridge screw	12 Nm	
SR SUNTOUR Suspension side, top, plastic	5 Nm	
SR SUNTOUR Suspension side, top, aluminium	20 Nm	
SR SUNTOUR Suspension side, bottom	10 Nm	Hex bit (torque)
SR SUNTOUR Suspension side, bottom	8 Nm	Aluminium nut (torque)
SR SUNTOUR Suspension side, bottom, (Adjust deflection)	7 Nm	
SR SUNTOUR Damping side, top, plastic	5 Nm	

SR SUNTOUR Damping side, top, aluminium	20 Nm	
SR SUNTOUR Damping side, bottom, without adjuster	10 Nm	
SR SUNTOUR Damping side, bottom, with adjuster	7 Nm	
SR SUNTOUR Fork head clamps	7 Nm	
SRAM RockShox, 35 Cover cap	28 Nm	socket nut, 24 mm
SRAM RockShox, Lyrik, ZEB Compression damper cover cap	28 Nm	RockShox cover cap/cassette tool (or standard cassette tool)
SRAM RockShox, Lyrik, ZEB DebonAir+ suspension cover cap	28 Nm	RockShox cover cap/cassette tool (or standard cassette tool)
SRAM RockShox, Lyrik, ZEB Dual Position air suspension cover cap	28 Nm	socket nut, 24 mm
SRAM RockShox, 35 Attachment screw – compression adjustment ring and remote operation ring	1.4 Nm	2.5 mm hex bit
SRAM RockShox, Lyrik, ZEB Attachment screw – compression adjuster Charger RC (Select)	1.35 Nm	2.5 mm hex bit
SRAM RockShox, Lyrik, ZEB Attachment screw – compression adjustment ring Charger RC (Select)	0.75 ... 1.1 Nm	2.5 mm hex bit
SRAM RockShox, 35 Attachment screw – deflection adjustment ring (Dual Position Coil)	1.35 Nm	2.5 mm hex bit
SRAM RockShox, Lyrik, ZEB ButterCup housing guide rod end plate - end plate to guide rod - air suspension and damper	3.3 Nm	Torx® T25
SRAM RockShox, Lyrik, ZEB ButterCup housing (top) to ButterCup housing (bottom) – air suspension and damper	3.3 Nm	23 mm spanner head
SRAM RockShox Bottomless Tokens	4 Nm	8 mm socket nut and 24 mm hex bit
SRAM RockShox, Lyrik, ZEB Sealing head (rebound) for damper cartridge barrel cover cap – Charger RC (Select), Rush RC (Base)	2 Nm	10 mm socket nut
SRAM RockShox, Lyrik, ZEB Pressure relief valve (PRV) and stopper	9 Nm	19 mm spanner head

SRAM RockShox Locking screw – remote control stop ring	Hand-tight or 0.1 ... 0.3 Nm	2 mm hex bit
SRAM RockShox, Lyrik, ZEB Clamping screw – rebound adjuster ring	0.84 Nm	2.5 mm hex bit
SRAM RockShox, Lyrik, ZEB Air suspension guide rod insert (Select+, Select, Base – only DebonAir+)	3.3 Nm	5 mm hex bit
SRAM RockShox, Lyrik, ZEB Cam adjuster clamping screw – compression damper adjuster (HSC) × 2	0.56 Nm	2.5 mm hex bit
SRAM RockShox Lower screws	6.8 Nm	5 mm hex bit
Handbrake		
SHIMANO Attachment screw	6 ... 8 Nm	Hex key, 4 mm Hex key, 5 mm
SHIMANO Attachment screw BL-M987/ BL-M9000/BL-M9020	4 ... 6 Nm	Hex key, 4 mm
SHIMANO, lever for disc brake Bleed nipple	4 ... 6 Nm	Socket wrench, 7 mm
SHIMANO, lever for disc brake Bleed screw	0.3 ... 0.5 Nm	...
TEKTRO for hydraulic disc brake system Attachment screws	5 ... 7 Nm	Hex key, 4 mm
Chainring		
FIT, Brose FIT Crank start spider locking	28 Nm	ISIS bottom bracket axle tool
FIT, Panasonic FIT Crank star screws	13 Nm	Hex key, 5 mm
FIT, Panasonic FIT Crank start spider locking	40 Nm	ISIS bottom bracket axle tool
FIT, Panasonic FIT Crank star screws	13 Nm	Hex key, 5 mm
SHIMANO, for MTB/trekking Largest chainring Medium chainring Smallest chainring	14 ... 16 Nm 16 ... 17 Nm	...
SHIMANO, single version Attachment screw for crank/chainring	12 ... 14 Nm	5 mm hex key/star bit [No. 30]
SHIMANO, dual version Largest chainring Smallest chainring	12 ... 14 Nm 16 ... 17 Nm	5 mm hex key/star bit [No. 30] 5 mm hex key/star bit [No. 30]
SHIMANO, triple design Largest chainring Medium chainring Smallest chainring	12 ... 14 Nm 16 ... 17 Nm	5 mm hex key/star bit [No. 30] 5 mm hex key/star bit [No. 30]

SHIMANO, FC-M8000, single version Attachment screw for crank/ chainring	12 ... 14 Nm	Star bit [no. 30]
SHIMANO, FC-M8000, dual version Largest chainring Smallest chainring	12 ... 14 Nm 16 ... 17 Nm	Star bit [no. 30] Star bit [no. 30]
SHIMANO, FC-M8000, triple version Largest chainring Medium chainring Smallest chainring	10 ... 12 Nm 16 ... 17 Nm	Star bit [no. 30] Star bit [no. 30]
Chain guard		
Brose chain guard bash guard Attachment screws	6 Nm	Hex key, 3 mm
Chain guard for BOSCH Motor BDU37xx Attachment screws	max. 10 Nm	M6 × 10; head: max. 5 mm; length: max. 8.5-mm
Crank bearing/crank set		
Conventional cartridge crank bearing	35 ... 45 Nm	...
SHIMANO, HOLLOWTECH li/two-part crank set Linker for adapter and inner sleeve	35 ... 50 Nm	TL-FC24/TL-FC25/TL-FC32/TL-FC36
SHIMANO, HOLLOWTECH li/two-part crank set Cap	0.7 ... 1.5 Nm	TL-FC16 / TL-FC18
SHIMANO, HOLLOWTECH li/two-part crank set Screw for left-hand crank arm	12 ... 14 Nm	Hex key, 5 mm
SHIMANO, OCTALINK model Linker for adapter and main body	50 ... 70 Nm	TL-UN74-S/ TL-UN66
SHIMANO, OCTALINK model Crank set	35 ... 50 Nm	Hex key, 8 mm Hex key, 10 mm
SHIMANO, SQUARE model Linker for adapter and body	50 ... 70 Nm	TL-UN74-S
SHIMANO, SQUARE model Crank set	35 ... 50 Nm	Hex key, 8 mm
Handlebars		
Clamping screw, conventional	5 ... 7 Nm*	#
CONTROL TECH Handlebar clamp with one or two screws	14 ... 16 Nm	#
SHIMANO Handlebar clamp with one or two screws	20 ... 29 Nm	#
Motor		
FIT, Brose S-Mag FIT Motor attachment screws (horizontal/vertical)	23/25 Nm	Socket wrench, AF 13 mm Hex key, AF 6 mm
FIT, Panasonic FIT Motor attachment screws	20 ... 24 Nm	Hex key, 6 mm

BOSCH motor BDU37xx 6 x attachment screws for motor	20 ± 2 Nm	Torx Plus® P40, M8 × 16
		
Motor cover		
BOSCH motor cover BDU37xx		
Attachment screws for lower motor cover	Initial fitting: 3 ± 0.5 Nm Retrofit: 2 ± 0.5 Nm	Torx® TX 20
Attachment screws for motor cover	Initial fitting: 3 ± 0.5 Nm Retrofit: 2 ± 0.5 Nm	Torx® TX 20, 4 × 8 mm
Brose FIT motor cover	1 Nm	Hex key, 3 mm
Hub		
ROHLOFF, 14/500 Bayonet lock/cable drum screws	1.5 Nm	2 mm hex bit
ROHLOFF, 14/500 Oil drain screw	0.5 Nm	3 mm hex bit
ROHLOFF, 14/500 Attachment screw for chain tensioner and torque support collar	...	5 mm hex bit
ROHLOFF, 14/500 To rotate the gear shift shaft	...	Open-end spanner 8 mm
ROHLOFF, 14/500 All other screws	3 Nm	Torx® TX 20
ROHLOFF, 14/500 CC versions	7 Nm	
ROHLOFF, 14/500 Axle nut TS	30 ... 35 Nm	
ROHLOFF, 14/500 Frame collar clamp attachment screw	6 Nm	4 mm hex bit
ROHLOFF, 14/500 Axle plate attachment screw	7 Nm	5 mm hex bit
ROHLOFF, 14/500 Chainring screws	7 Nm	5 mm hex bit
ROHLOFF, 14/500 Attachment screw for disc brake mount	8 Nm	M6
ROHLOFF, 14/500 Disc brake attachment screw	10 Nm	5 mm hex bit
ROHLOFF, 14/500 Axle plate screws	3 Nm	Torx® TX 20
ROHLOFF, 14/500 Torque support collar clamp screw	2.5 Nm	
ROHLOFF, 14/500 Frame collar clamp	6 Nm	SW10 screw wrench; hold screw in place with 4 mm hex bit

ROHLOFF, 14/500 Chain tensioner attachment screw	8 Nm	5 mm hex bit
ROHLOFF, 14/500 Chain guide attachment screw	3 Nm	Torx® TX 20
ROHLOFF, 14/500 Rear spacer sleeve attachment screw	3 Nm	Torx® TX 20
ROHLOFF, 14/500 Attachment screw for shift handle on handlebars	1 Nm	2.5 mm hex bit
ROHLOFF, 14/500 End stop	3 Nm	Torx® TX 20
ROHLOFF, 14/500 Cable guide	6 Nm	4 mm hex bit
SHIMANO quick release version FH-M3050, FH-M4050, FH-MT200-B, FH-MT400, FH-MT400-B, FH-MT500, FH-MT500-B, FH-MT510, FH-MT510-B, FH-RM33, FH-RM35, FH-TX505 FH-TY505, FH-UR600 HB-M3050, HB-M4050, HB-MT200, HB-MT400, HB-MT400-B, HB-RM33, HB-TX505 SLX FH-M7000, FH-M7010, FH-M7010-B HB-M7000, HB-M7010, HB-M7010-B DEORE FH-M618, FH-M618-B, FH-M6000, FH-M6010, FH-M6010-B, HB-M618, HB-M618-B, HB-M6000, HB-M6010, HB-M6010-B Brake disc attachment screw	40 Nm	Adjustable spanner and special tool TL-LR15 (SHIMANO)
SHIMANO E-THRU quick release axle Retaining ring for brake disc	40 Nm	Special tool TL-FC36 (SHIMANO)
SHIMANO, FH-M3050, FH-M4050, FH-M7000, FH-M6000, FH-RM33, FH-RM35, FH-UR600 Attachment screw, freewheel body	35 ... 50 Nm	10 mm hex bit
SHIMANO, FH-MT200, FH-TX505, FH-TY505 Attachment screw, freewheel body	147 ... 200 Nm	12 mm hex bit
SHIMANO, FH-M7010, FH-M7010-B, FH-M6010, FH-M6010-B, FH-M618, FH-M618-B, FH-MT400, FH-MT400-B, FH-MT500, FH-MT500-B, FH-MT510, FH-MT510-B Lock nut	15 ... 20 Nm	Hub spanner, 17 mm

SHIMANO , HB-M7000, HB-M6000 HB-M4050 Lock nut	10 ... 15 Nm	Hub spanner, 13 mm and 17 mm
SHIMANO , HB-M7010, HB-M7010-B HB-M6010, HB-M6010-B, HB-M618, HB-M618-B, HB-MT400, HB-MT400-B Lock nut	21 ... 26 Nm	Hub spanner, 22 mm
SHIMANO hub dynamo E2 model	20 - 25 Nm	Screw wrench
SHIMANO hub dynamo J2 model	20 Nm	Screw wrench
SHIMANO hub dynamo J2-A model	20 Nm	Screw wrench
Pedal		
Pedal, conventional	33 ... 35 Nm	Screw wrench, 15 mm
SHIMANO Attachment screw	35 ... 55 Nm	Screw wrench, 15 mm
Seat post		
by.schulz, G1 M8 seat clamp screw M5 fixing grub screws	20 ... 24 Nm 3 Nm	2.5 mm hex bit
by.schulz, G2 M6 seat clamp screw M5 fixing grub screws	12 ... 14 Nm 3 Nm	2.5 mm hex bit
EIGHTPINS NGS2 Seat post axle Slipper clutch Valve cover Post pin axle Rear clamping screw (saddle) M5 attachment screw for outer sleeve	8 Nm 18 Nm 0.5 Nm 8 Nm 8 Nm 0.5 Nm	6 mm hex bit 3 mm hex bit 5 mm hex bit 5 mm hex bit 3 mm hex bit 3 mm hex bit
EIGHTPINS H01 Seat post axle Slipper clutch Valve cover Post pin axle Rear clamping screw (saddle) M5 attachment screw for outer sleeve	8 Nm 18 Nm 0.5 Nm 8 Nm 8 Nm 0.5 Nm	6 mm hex bit 3 mm hex bit 5 mm hex bit 5 mm hex bit 3 mm hex bit 3 mm hex bit
LIMOTEC LimoDP Clamping screw for seat post Clamping screw for saddle	6 ... 7 Nm 7 ... 9 Nm	
SR SUNTOUR suspension seat post Saddle clamp screw M5 fixing grub screws	15 ... 18 Nm 3 Nm	5.0 mm hex bit 2.5 mm hex bit
Shifter		
SHIMANO DEORE SL-M4100 Attachment screw	3 Nm	4 mm hex bit
SHIMANO DEORE SL-M5100 Attachment screw	3 Nm	4 mm hex bit
SHIMANO DEORE SL-M6100 Attachment screw	3 Nm	4 mm hex bit

SHIMANO DEORE XT SL-M8100 Attachment screw	3 Nm	4 mm hex bit
SHIMANO DEORE XT SL-M8130 Attachment screw	3 Nm	4 mm hex bit
SHIMANO, SLX SL-M7100 Attachment screw	3 Nm	4 mm hex bit
SHIMANO XTR SL-M9100 Attachment screw	3 Nm	4 mm hex bit
SRAM AXS Controller Collar attachment screw	2 Nm	Torx® T25
Rear derailleur		
SHIMANO for MTB/trekking Attachment screw, standard type	8 ... 10 Nm	Hex key, 5 mm
SHIMANO for MTB/trekking Attachment screw with bracket	3 ... 4 Nm	Hex key, 5 mm
SHIMANO for BMX bicycles Attachment screw	3 ... 4 Nm	Adjustable spanner
SHIMANO for MTB/trekking Attachment screw for inner cable	6 ... 7 Nm	Hex key, 4 mm/ Hex key, 5 mm/ Adjustable spanner
SHIMANO for MTB/trekking Attachment screw for the guide pulley	2.5 ... 5 Nm	Hex key, 3 mm
SHIMANO for MTB/trekking Attachment screw for the tensioning roller	2.5 ... 5 Nm	Hex key, 3 mm
SHIMANO for racing bicycles Attachment screw, standard type	8 ... 10 Nm	Hex key, 5 mm
SHIMANO for racing bicycles Attachment screw with bracket	3 ... 4 Nm	Screw wrench
SHIMANO for racing bicycles Attachment screw for inner cable	6 ... 7 Nm	Hex key, 4 mm/ Hex key, 5 mm
SHIMANO for racing bicycles Attachment screw for pulley	2.5 ... 5 Nm	Hex key, 3 mm
Headlight		
FUXON headlight Attachment screw	>5 Nm	...
SUPERNOVA, M99 Pure/Pure+, V521s Attachment screw	2 Nm	M6 attachment screw, self-locking nut, washer
SUPERNOVA, M99 Pure/Pure+, V521s Stem screw	6 Nm	
Front derailleur		
SHIMANO for MTB/trekking Attachment screw, clip type, E-type and direct fitting	5 ... 7 Nm	Hex key, 5 mm

SHIMANO for MTB/trekking Inner bearing adapter	35 ... 50 Nm	...
SHIMANO for MTB/trekking Top swing screw, clip type and e-type	5 ... 7 Nm	Hex key, 5 mm/ Screw wrench, 9 mm
SHIMANO for MTB/trekking Down swing screw, clip type, direct fitting	5 ... 7 Nm	Hex key, 5 mm
SHIMANO for racing bicycles Attachment screw	5 ... 7 Nm	Hex key, 5 mm/ Screw wrench, 9 mm
SHIMANO for racing bicycles Bowden cable attachment screw	6 ... 7 Nm	Hex key, 5 mm
Underride guard		
FIT, Brose Attachment screws	6 Nm	Socket wrench, 8 mm Hex key, 4 mm Hex key, 3 mm
V-Brake brake		
SHIMANO Attachment screw for connecting cable	6 ... 8 Nm	Hex key, 5 mm
SHIMANO Brake shoe nut	6 ... 8 Nm	Hex key, 5 mm
SHIMANO Bowden cable attachment screw	6 ... 8 Nm	Hex key, 5 mm
Stem		
FSA, carbon quill stem	9 Nm	15 mm spanner

9 Troubleshooting, fault clearance and repair

9.1 Preventing pain

The pedelec is both a means of transport and a piece of sports equipment that promotes health.

After the first few rides, you may experience sore muscles the next day. However, permanent pain should never occur during or after a ride.

The most common complaints are:

- Sitting discomfort
- Pain in hips
- Backache
- Pain in shoulders and nape of neck
- Numb or aching hands
- Pain in upper thigh
- Pain in the knee
- Pain in the foot

If you suffer from one or more of the complaints above, take the following action steps:

- 1** Check the correct adjustment of all components. In most cases, however, pain after pedelec rides is due to a lack of training and components set incorrectly or components that are not adjusted to the rider's physique.
- 2** Consult a doctor as soon as possible and talk openly about the complaints. Pain may be a sign of medical problems that need to be treated.



- 3** If the doctor does not diagnose a medical condition, visit a gym, sports trainer or physiotherapist. Personalised stretching or musculature strengthening exercises must be supervised to ensure they are performed correctly.

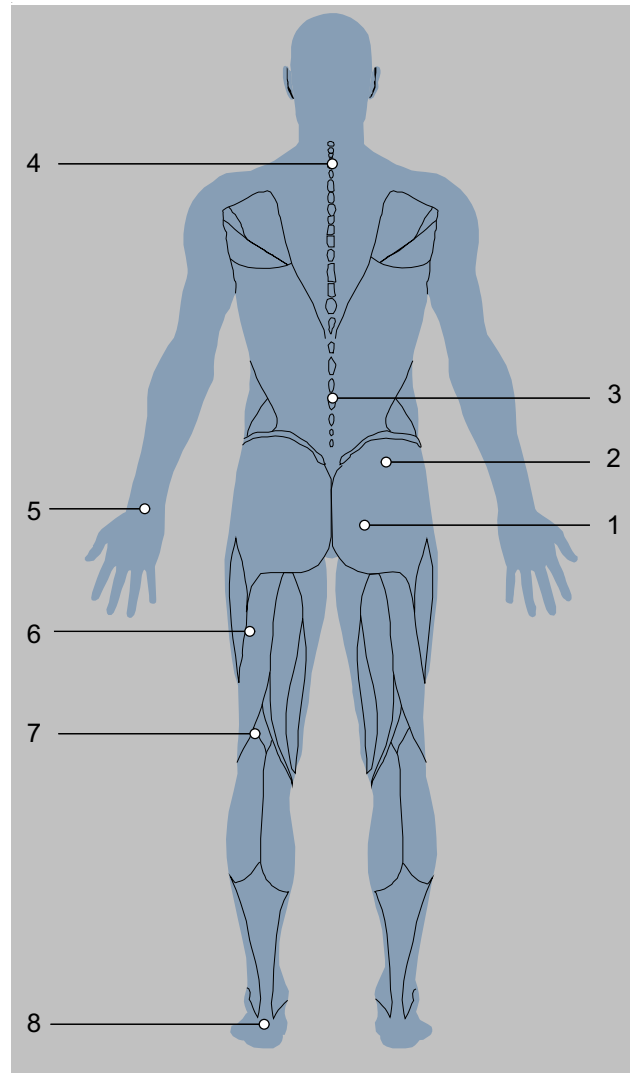

Figure 189: Known pain due to lack of training and/or incorrect component adjustment

9.1.1 Sitting discomfort

Around 50% of all pedelec riders experience sitting discomfort:

- Pressure pain in the sitting bones
- Pain in the lower back
- Pressure pain and numbness in perineal region

Solution

- Adopt an optimal riding position (see Section 6.5.2).
- Adjust the saddle height and tilt (see Section 6.5.4).
- Wear cycling shorts and use chamois cream (see Section 6.12).
- Use an ergonomically adjusted saddle (see Section 6.5.4).

- Ride standing up now and again.



9.1.2 Pain in hips

Lower back pain is often not caused by the back muscles, but by the iliopsoas muscle instead. This muscle is part of the inner hip musculature and flexes the hip. It is attached to the thigh bone and reaches up to the spine. Pain can occur in the back if this muscle is strained too much or shortened.

Solution

- Strengthening exercises for the iliopsoas muscle
- Stretching exercises for hip flexors and extensors.



9.1.3 Backache

Riding a pedelec strengthens the back musculature. The greater the saddle-to-bar drop is, the greater the strain on the back musculature is. At the beginning, a posture where you lean too far forward can lead to pain in the back, arms and wrists. The abdominal muscles are the counterpart to the back muscles and stabilise the pelvis and the back. Back pain is thus often caused by weak abdominal muscles.

Solution

- Contact specialist dealer. You need to adopt a more upright sitting position (see Section 6.5.3).

- Stretching exercises for the back and abdominal muscle ligaments and moderate bicycle training will lengthen the tendons and build new back and abdominal muscles.



The desired position can be adopted after a period of training.

9.1.4 Pain in shoulders and nape of neck

The weight of the upper body places a strain on the shoulders due to the bent-forward posture. The more stretched the position is, the more strain there is on the shoulders.

The specific posture adopted is often the source of pain. Pedelec riders often extend their arms. Impacts such as those occurring on bumpy roads are thus transmitted to the shoulders without suspension. This causes severe pain.

Another source of pain is a hunchback. Due to the posture adopted, the neck needs to be extended backwards excessively so that the rider can look forwards. This causes strain in the neck and shoulder muscles.

9.1.5 Numb or aching hands

Your hands are one of the three points of contact when you ride a pedelec. The hands transmit the weight of the upper body to the handlebars. In the upright Holland position, there is almost no weight applied whereas body weight is at its highest in the sports position. The force is applied to a small area on the handle, meaning the pressure load on the hands is very high. Hands are highly sensitive and can bear a maximum of 20% of body weight during prolonged exposure to load.

9.1.6 Pain in upper thigh

Pain in the upper thigh is usually due to muscular problems. A muscular imbalance between the extensors, flexors and adductors can cause this pain.

Solution



- A more upright riding position will immediately reduce pain.
- Always bend elbows slightly.
- ⇒ The elbow joint will not block. The arms cushion impacts.
- Adjust the handlebars (see Section 6.5.5).
- Always adopt an optimal riding position (see Section 6.5.3).

Solution

- Position handles perfectly (see Section 6.5.5.1, 6.5.5.2 and 6.5.8).
- Move hands and arms while riding (see Section 6.15).
- Use padded cycling gloves (see Section 2.15).
- Optimise handles (see Section 6.5.7).

Solution

- Increasing assistance on the pedelec will bring immediate relief.



- Targeted exercises to correct imbalance and shortening of the thigh muscles.
- Stretching exercises for the thigh muscles.

9.1.7 Knee pain

Pedelec riding is a sport that is easy on the knee joints and is recommended for beginners. Very powerful forces are transmitted from the thigh to the foot via the knee when pedalling. As a result, the tendons and cartilage in the knee are subjected to great stress.

Pain on the inside and outside of the knee is often caused by incorrect adjustment of the click system and the foot being out of position as a consequence. Pain in the lower part of the knee usually stems from an improper riding position.

Cold weather can also cause knee pain. Tendons are less elastic at low temperatures and thus rub against the knee more.

If the knee is out of position, the cartilage becomes very worn. Ligaments that are too short or muscular imbalances can increase this effect. Pain on the top of the kneecap often indicates a muscular imbalance. Pain under the kneecap is usually related to excessive pressure in the knee joint and consequential irritation to the patellar tendon.

9.1.8 Pain in the foot

Your feet are one of three points of contact when you ride a pedelec. Feet transmit force from the upper thigh to the pedal, thus driving the pedelec. In the process, your feet are subjected to between 100% and, during jumps, even up to 1,000% of your body weight.

Foot pain often arises when the saddle is too low or the foot is placed incorrectly on the pedal.

Unsuitable shoes can also be the cause of pain in the feet.

Solution

- Contact specialist dealer. Have the pedelec adjusted (see Section 6.5). Then measure the wheel.
- Avoid cold.



- Get imbalances under control through stretching exercises, strengthening the muscles and Blackroll training.

Solution

- Wear sturdy shoes which are not too tightly laced (see Section 2.5).
- Position feet correctly on the pedals (see Section 6.13).
- Adjust the saddle height to an optimum position (see Section 6.5.4).

9.2 FIT drive system

The components of the drive system are checked constantly and automatically. If an error is detected, an error message appears on the *display*. The drive may be shut off automatically, depending on the type of error.

9.2.1 The drive system or display do not start up

If the display and/or the drive system do not start up, proceed as follows:

- 1 Check whether the battery is switched on. If not, start the battery.
- ⇒ Contact your specialist dealer if the battery level indicator LEDs do not light up.
- 2 If the LEDs on the battery level indicator light up, but the drive system does not start up, remove the battery.
- 3 Insert the battery.
- 4 Start the drive system.
- 5 If the drive system does not start up, remove the battery.
- 6 Clean all the contacts with a soft cloth.

- 7 Insert the battery.
- 8 Start the drive system.
- 9 If the drive system does not start up, remove the battery.
- 10 Fully charge the battery.
- 11 Insert the battery.
- 12 Start the drive system.
- 13 If the drive system does not start, press the **On-Off button (control panel)** for at least 8 seconds.
- 14 If the drive system does not start after about 6 seconds, press the **On-Off button (control panel)** for at least 2 seconds.
- 15 Contact your specialist dealer if the drive system does not start.

9.2.2 Warning messages and LEDs

All warning messages and the meaning of the different LEDs are explained in Section 6.2.

9.2.3 Errors in the assistance system

Symptom	Cause	Remedy
Assistance is not available.	Is the speed too high?	1 Check on-screen indicators. The electronic gear assistance is only active up to a maximum speed of 25 km/h.
	Is the battery charged sufficiently?	2 Check battery is charged. 3 Recharge the battery if it is almost flat.
	The battery may become too hot during rides at high temperatures, up long inclines or when carrying a heavy load for a long time.	4 Switch off the drive system. 5 Wait a moment and then check again.
	The rechargeable battery, display or assistance switch may be connected incorrectly, or one or more of them may have a problem.	6 Contact your specialist dealer.
Assistance is not available.	Are the pedals being pushed?	7 The pedelec is not a motorbike. Push the pedals.
	Is the system switched on?	8 Press On-Off button (battery) to switch on the system.
	Is the assistance mode set to [OFF]?	9 Set the assistance mode to a different level of assistance than [OFF]. 10 Contact your specialist dealer if you still feel that no assistance is being supplied.

Table 125: Error solution for assistance system

Symptom	Cause	Remedy
The assisted journey distance is too short.	The battery does not perform as well in winter weather.	This does not indicate a problem.
	The journey distance can be shorter depending on the road conditions, the gear level and the entire light usage time.	11 Check battery is charged. 12 Recharge the battery if it is almost flat.
	Is the battery fully charged?	13 If the distance covered with a fully charged battery has become shorter, the battery may be affected. Replace the battery with a new one.
	The battery is a consumable. Repeated charging and long periods of use cause the battery to degrade (loss of power).	14 If the distance you can cover with one single charge is very short, replace the battery with a new one.
It is difficult to pedal.	Are the tyres pumped to an adequate pressure?	15 Pump up tyres.
	Is the assistance mode set to [OFF]?	16 Set level of assistance to [HIGH], [STD], [ECO] or [AUTO].
	The battery charge might be low.	17 Check battery is charged. 18 Recharge the battery if it is almost flat.
	Have you switched on the system with your foot on the pedal?	19 Switch on the system again without applying pressure to the pedals. 20 Contact your specialist dealer if assistance is still not supplied.

Table 125: Error solution for assistance system

9.2.4 Battery error

Symptom	Cause	Remedy
The battery discharges very quickly.	The battery may be at the end of its useful life.	► Replace old battery with new one.
The battery cannot be recharged.	Is the charger mains plug firmly connected to the socket?	21 Disconnect the charger mains plug. 22 Insert the mains plug. 23 Start charging.
	Is the charger plug firmly connected to battery?	24 If the battery still won't recharge, disconnect the charger plug. 25 Insert charger plug. 26 Start charging.
	Is the adapter firmly connected to the charger plug or the battery's charging port?	27 If you are still unable to recharge the battery, connect the adapter with the charger plug or the battery's charger connection. 28 Start charging.
	Is the connection terminal for the charger, charger adapter or battery dirty?	29 If you are still unable to recharge the battery, wipe the connection terminals with a dry cloth to clean them. 30 Start charging. 31 Contact your specialist dealer if the battery still won't recharge.
The battery does not start charging when the charger is connected.	The battery may be at the end of its useful life.	► Replace old battery with new one.

Table 126: Error solution for battery

Symptom	Cause	Remedy
The battery and charger become hot.	The battery or charger temperature may have exceeded the operating temperature range.	32 Interrupt charging process. 33 Wait a moment. 34 Start charging. 35 If the battery is too hot to touch, there might be a problem with the battery. Contact your specialist dealer.
The charger is hot.	If the charger is used continuously to charge batteries, it may become hot.	36 Wait a moment. 37 Start charging.
The LED on the charger does not light up.	The LED on the charger will go out when the battery is fully charged.	This is not a malfunction.
	Is the charger plug firmly connected to battery?	38 Check the connection for any contaminants. 39 Insert charger plug. 40 Contact your specialist dealer if there is no change.
	Is the battery fully charged?	41 Disconnect the charger mains plug if there is no change. 42 Insert the mains plug. 43 Start charging. 44 Contact your specialist dealer if the LED on the charger still doesn't light up.
The battery cannot be removed.		► Contact your specialist dealer.
The battery cannot be inserted.		► Contact your specialist dealer.
Fluid is leaking from the battery.		► Observe all the warnings in Section 2 Safety.
There is an unusual smell.		45 Remove the battery from the pedelec immediately. 46 Contact the fire service. 47 Observe all the warnings in Section 2 Safety.
Fumes are emitted from the battery.		48 Remove the battery from the pedelec immediately. 49 Contact the fire service. 50 Observe all the warnings in Section 2 Safety.

Table 126: Error solution for battery

9.2.5 PINION error message

9.2.5.1 Display

The drive system monitors itself continuously and indicates a known hazard with a warning symbol or displays a number as an error message if a known error is detected. The system may switch off automatically depending on the type of error. The pedelec can still be used as a normal bicycle even if the motor no longer provides assistance.

Status LED

There is a status LED in the top left-hand corner of the display screen.

Colour	Flash sequence	Status
GREEN	Lights up	1 Connect system to maintenance tool at the specialist dealer's.
RED	Lights up	1 Restart system. 2 If the remote continues to light up red, have the component replaced at the specialist dealer's.
RED	Flashes	1 Restart system. 2 If the remote continues to light up red, have the component replaced at the specialist dealer's.

Table 127: Status LED

Warnings

Hazardous situations are indicated with warning symbols on the display screen.







Symbol	Description	Method of resolution
	Temperatures are below 4 °C	<ul style="list-style-type: none"> ▶ Take care while riding. ▶ Provide winter protection.
	The system gives warning of an error	<ol style="list-style-type: none"> 1 Start system. 2 Contact your specialist dealer if the problem persists.
	Maintenance is due	<ul style="list-style-type: none"> ▶ Check whether buttons are jammed because dirt has accumulated between them, for example. ▶ Clean buttons if necessary.
	Motor overheating	<p>The available riding assistance power is limited.</p> <ul style="list-style-type: none"> ▶ Leave pedelec to cool down.
	Reduction in power	<p>The available riding assistance power is limited.</p> <ul style="list-style-type: none"> ▶ Contact your specialist dealer.
	Low tyre pressure	<p>Function is only available with the tyre pressure sensor.</p> <ul style="list-style-type: none"> ▶ Check tyre pressure and adjust if necessary.

Table 128: List of display screen warning symbols

Error messages



Figure 190: Example of an error message

- ▶ Press on the Menu button.
 - ⇒ The error is acknowledged.
 - ⇒ The display screen shows the DRIVE MAIN MENU.
- If the error cannot be acknowledged, use the corresponding solution from the following tables.

Code	Description	Method of resolution
0A-01, 0B-01	Remote Communication Error	<ol style="list-style-type: none"> 1 Restart system. 2 Contact your specialist dealer if the problem persists.
0A-02, 0B-02	Remote Communication Error	<ol style="list-style-type: none"> 1 Restart system. 2 Switch off system. 3 Remove display from mount, check contacts and clean if necessary. 4 Re-insert display and start system. 5 Contact your specialist dealer if the problem persists.
0A-03, 0A-04, 0B-03, 0B-04, 0B-05, 0B-06	Remote-Battery Communication Error	<ol style="list-style-type: none"> 1 Restart system. 2 Contact your specialist dealer if the problem persists.
0A-07, 0B-07	Remote-Speednode Communication Error	<ol style="list-style-type: none"> 1 Restart system. 2 Contact your specialist dealer if the problem persists.
0A-08, 0B-08	Remote-Gear Shift Communication Error	<ol style="list-style-type: none"> 1 Restart system. 2 Contact your specialist dealer if the problem persists.

Table 129: List of display screen error messages

Code	Description	Method of resolution
0A-0A, 0B-0A	Remote-Charger Communication Error	<ol style="list-style-type: none"> 1 Restart system. 2 Switch off system. 3 Disconnect charger from system and socket. 4 Wait until the status LED goes out. 5 Check plug contacts on pedelec and charger and clean if necessary. 6 Plug charger into the socket again. 7 Plug charger into the system again and start system. 8 Contact your specialist dealer if the problem persists.
0A-0B, 0B-0B	Remote-Lock Communication Error	<ol style="list-style-type: none"> 1 Restart system. 2 Contact your specialist dealer if the problem persists.
0C-00	Remote Identification Error	<ol style="list-style-type: none"> 1 Restart system. 2 Contact your specialist dealer if the problem persists.
0C-01	Remote-Motor Identification Error	<ol style="list-style-type: none"> 1 Restart system. 2 Contact your specialist dealer if the problem persists.
0C-02	Remote-Display Identification Error	<ol style="list-style-type: none"> 1 Restart system. 2 Contact your specialist dealer if the problem persists.
0C-03, 0C-04, 0C-05, 0C-06	Remote-Battery Identification Error	<ol style="list-style-type: none"> 1 Switch off system. 2 Remove battery from mount. 3 Check contacts and clean if necessary. 4 Re-insert battery. 5 Start system. 6 Contact your specialist dealer if the problem persists.
0C-07	Remote-Speednode Identification Error	<ol style="list-style-type: none"> 1 Restart system. 2 Contact your specialist dealer if the problem persists.
0C-08	Remote-Gear Shift Identification Error	<ol style="list-style-type: none"> 1 Restart system. 2 Contact your specialist dealer if the problem persists.

Table 129: List of display screen error messages

Code	Description	Method of resolution
0C-0A	Remote-Charger Identification Error	<ol style="list-style-type: none"> 1 Restart system. 2 Switch off system. 3 Disconnect charger from system and socket. 4 Wait until the status LED goes out. 5 Check plug contacts on pedecec and charger and clean if necessary. 6 Plug charger into the socket again. 7 Plug charger into the system again and start system. 8 Contact your specialist dealer if the problem persists.
0C-0B	Remote-Lock Identification Error	<ol style="list-style-type: none"> 1 Restart system. 2 Contact your specialist dealer if the problem persists.
0D-01	Motor Authentication Error	<ol style="list-style-type: none"> 1 Restart system. 2 Contact your specialist dealer if the problem persists.
0D-02	Display Authentication Error	<ol style="list-style-type: none"> 1 Restart system. 2 Switch off system. 3 Remove display from mount, check contacts and clean if necessary. 4 Re-insert display and start system. 5 Contact your specialist dealer if the problem persists.
0D-03 0D-04 0D-05 0D-06	Battery Authentication Error	<ol style="list-style-type: none"> 1 Switch off system. 2 Remove battery from mount. 3 Check contacts and clean if necessary. 4 Re-insert battery. 5 Start system. 6 Contact your specialist dealer if the problem persists.
0D-07	Speednode Authentication Error	<ol style="list-style-type: none"> 1 Restart system. 2 Contact your specialist dealer if the problem persists.

Table 129: List of display screen error messages

Code	Description	Method of resolution
0D-0A	Charger Authentication Error	<ol style="list-style-type: none"> 1 Restart system. 2 Switch off system. 3 Disconnect charger from system and socket. 4 Wait until the status LED goes out. 5 Check plug contacts on pedecec and charger and clean if necessary. 6 Plug charger into the socket again. 7 Plug charger into the system again and start system. 8 Contact your specialist dealer if the problem persists.
0D-0B	Lock Authentication Error	<ol style="list-style-type: none"> 1 Restart system. 2 Contact your specialist dealer if the problem persists.
0E-xx	Remote Authentication Error	<ol style="list-style-type: none"> 1 Restart system. 2 Contact your specialist dealer if the problem persists.
0F-00	Remote Update Error	<ol style="list-style-type: none"> 1 Restart system. 2 Contact your specialist dealer if the problem persists.
0F-01	Motor Update Error	<ol style="list-style-type: none"> 1 Restart system. 2 Contact your specialist dealer if the problem persists.
0F-02	Display Update Error	<ol style="list-style-type: none"> 1 Restart system. 2 Switch off system. 3 Remove display from mount, check contacts and clean if necessary. 4 Re-insert display and start system. 5 Contact your specialist dealer if the problem persists.
0F-03, 0F-04, 0F-05, 0F-06	Battery Update Error	<ol style="list-style-type: none"> 1 Switch off system. 2 Remove battery from mount. 3 Check contacts and clean if necessary. 4 Re-insert battery. 5 Start system. 6 Contact your specialist dealer if the problem persists.

Table 129: List of display screen error messages

Code	Description	Method of resolution
0F-07	Speednode Update Error	<ol style="list-style-type: none"> 1 Restart system. 2 Contact your specialist dealer if the problem persists.
0F-08	Gear Shift Update Error	<ol style="list-style-type: none"> 1 Restart system. 2 Contact your specialist dealer if the problem persists.
0F-0A	Charger Update Error	<ol style="list-style-type: none"> 1 Restart system. 2 Switch off system. 3 Disconnect charger from system and socket. 4 Wait until the status LED goes out. 5 Check plug contacts on pedelec and charger and clean if necessary. 6 Plug charger into the socket again. 7 Plug charger into the system again and start system. 8 Contact your specialist dealer if the problem persists.
0F-08	Lock Update Error	<ol style="list-style-type: none"> 1 Restart system. 2 Contact your specialist dealer if the problem persists.
10-xx	Remote Software Error	<ol style="list-style-type: none"> 1 Restart system. 2 Contact your specialist dealer if the problem persists.
11-xx	Remote-Battery Communication Error	<ol style="list-style-type: none"> 1 Restart system. 2 Contact your specialist dealer if the problem persists.
12-01	Remote-Motor Pairing Error	<ol style="list-style-type: none"> 1 Restart system. 2 Contact your specialist dealer if the problem persists.
12-02	Remote-Display Pairing Error	<ol style="list-style-type: none"> 1 Restart system. 2 Switch off system. 3 Remove display from mount, check contacts and clean if necessary. 4 Re-insert display and start system. 5 Contact your specialist dealer if the problem persists.

Table 129: List of display screen error messages

Code	Description	Method of resolution
12-03, 12-04, 12-05, 12-06	Remote-Battery Pairing-Error	<ol style="list-style-type: none"> 1 Switch off system. 2 Remove battery from mount. 3 Check contacts and clean if necessary. 4 Re-insert battery. 5 Start system. 6 Contact your specialist dealer if the problem persists.
12-07	Remote-Speednode Pairing Error	<ol style="list-style-type: none"> 1 Restart system. 2 Contact your specialist dealer if the problem persists.
12-08	Remote-Gear Shift Pairing Error	<ol style="list-style-type: none"> 1 Restart system. 2 Contact your specialist dealer if the problem persists.
12-0A	Remote-Charger Pairing Error	<ol style="list-style-type: none"> 1 Restart system. 2 Switch off system. 3 Disconnect charger from system and socket. 4 Wait until the status LED goes out. 5 Check plug contacts on pedelec and charger and clean if necessary. 6 Plug charger into the socket again. 7 Plug charger into the system again and start system. 8 Contact your specialist dealer if the problem persists.
12-0B	Remote-Lock Pairing Error	<ol style="list-style-type: none"> 1 Restart system. 2 Contact your specialist dealer if the problem persists.
13-xx	Remote internal error	<ol style="list-style-type: none"> 1 Start system. 2 Contact your specialist dealer if the problem persists.
14-xx	Remote Configuration Error	<ol style="list-style-type: none"> 1 Start system. 2 Contact your specialist dealer if the problem persists.
15-01	Remote-Motor Pairing Error	<ol style="list-style-type: none"> 1 Restart system. 2 Contact your specialist dealer if the problem persists.

Table 129: List of display screen error messages

Code	Description	Method of resolution
15-02	Remote-Display Pairing Error	<ol style="list-style-type: none"> 1 Restart system. 2 Switch off system. 3 Remove display from mount, check contacts and clean if necessary. 4 Re-insert display and start system. 5 Contact your specialist dealer if the problem persists.
15-03, 15-04, 15-05, 15-06	Remote-Battery Pairing Error	<ol style="list-style-type: none"> 1 Switch off system. 2 Remove battery from mount. 3 Check contacts and clean if necessary. 4 Re-insert battery. 5 Start system. 6 Contact your specialist dealer if the problem persists.
15-07	Remote-Speednode Pairing Error	<ol style="list-style-type: none"> 1 Restart system. 2 Contact your specialist dealer if the problem persists.
15-08	Remote-Gear Shift Pairing Error	<ol style="list-style-type: none"> 1 Restart system. 2 Contact your specialist dealer if the problem persists.
15-0A	Remote-Charger Pairing Error	<ol style="list-style-type: none"> 1 Restart system. 2 Switch off system. 3 Disconnect charger from system and socket. 4 Wait until the status LED goes out. 5 Check plug contacts on pedepec and charger and clean if necessary. 6 Plug charger into the socket again. 7 Plug charger into the system again and start system. 8 Contact your specialist dealer if the problem persists.
15-0B	Remote-Lock Pairing Error	<ol style="list-style-type: none"> 1 Restart system. 2 Contact your specialist dealer if the problem persists.

Table 129: List of display screen error messages

Code	Description	Method of resolution
16-01	Motor Theft Detection	<ol style="list-style-type: none"> 1 Restart system. 2 Contact your specialist dealer if the problem persists.
16-02	Display Theft Detection	<ol style="list-style-type: none"> 1 Restart system. 2 Switch off system. 3 Remove display from mount, check contacts and clean if necessary. 4 Re-insert display and start system. 5 Contact your specialist dealer if the problem persists.
16-03, 16-04, 16-05, 16-06	Battery Theft Detection	<ol style="list-style-type: none"> 1 Switch off system. 2 Remove battery from mount. 3 Check contacts and clean if necessary. 4 Re-insert battery. 5 Start system. 6 Contact your specialist dealer if the problem persists.
16-07	Speednode Theft Detection	<ol style="list-style-type: none"> 1 Restart system. 2 Contact your specialist dealer if the problem persists.
16-08	Gear Shift Theft Detection	<ol style="list-style-type: none"> 1 Restart system. 2 Contact your specialist dealer if the problem persists.
16-0A	Charger Theft Detection	<ol style="list-style-type: none"> 1 Restart system. 2 Switch off system. 3 Disconnect charger from system and socket. 4 Wait until the status LED goes out. 5 Check plug contacts on pedepec and charger and clean if necessary. 6 Plug charger into the socket again. 7 Plug charger into the system again and start system. 8 Contact your specialist dealer if the problem persists.

Table 129: List of display screen error messages

Code	Description	Method of resolution
16-0B	Lock Theft Detection	<ol style="list-style-type: none"> 1 Restart system. 2 Contact your specialist dealer if the problem persists.
17-01	Motor Defective Component	<ol style="list-style-type: none"> 1 Restart system. 2 Contact your specialist dealer if the problem persists.
17-02	Display Defective Component	<ol style="list-style-type: none"> 1 Restart system. 2 Switch off system. 3 Remove display from mount, check contacts and clean if necessary. 4 Re-insert display and start system. 5 Contact your specialist dealer if the problem persists.
17-03, 17-04, 17-05, 17-06	Battery Defective Component	<ol style="list-style-type: none"> 1 Switch off system. 2 Remove battery from mount. 3 Check contacts and clean if necessary. 4 Re-insert battery. 5 Start system. 6 Contact your specialist dealer if the problem persists.
17-07	Speednode Defective Component	<ol style="list-style-type: none"> 1 Restart system. 2 Contact your specialist dealer if the problem persists.
17-08	Gear Shift Defective Component	<ol style="list-style-type: none"> 1 Restart system. 2 Contact your specialist dealer if the problem persists.
17-0A	Charger Defective Component	<ol style="list-style-type: none"> 1 Restart system. 2 Switch off system. 3 Disconnect charger from system and socket. 4 Wait until the status LED goes out. 5 Check plug contacts on pedevec and charger and clean if necessary. 6 Plug charger into the socket again. 7 Plug charger into the system again and start system. 8 Contact your specialist dealer if the problem persists.

Table 129: List of display screen error messages

Code	Description	Method of resolution
17-0B	Lock Defective Component	<ol style="list-style-type: none"> 1 Restart system. 2 Contact your specialist dealer if the problem persists.
18-01	Motor Start Error	<ol style="list-style-type: none"> 1 Restart system. 2 Contact your specialist dealer if the problem persists.
18-02	Display Start Error	<ol style="list-style-type: none"> 1 Restart system. 2 Switch off system. 3 Remove display from mount, check contacts and clean if necessary. 4 Re-insert display and start system. 5 Contact your specialist dealer if the problem persists.
18-03, 18-04, 18-05, 18-06	Battery Start Error	<ol style="list-style-type: none"> 1 Switch off system. 2 Remove battery from mount. 3 Check contacts and clean if necessary. 4 Re-insert battery. 5 Start system. 6 Contact your specialist dealer if the problem persists.
18-07	Speednode Start Error	<ol style="list-style-type: none"> 1 Restart system. 2 Contact your specialist dealer if the problem persists.
18-08	Gear Shift Start Error	<ol style="list-style-type: none"> 1 Restart system. 2 Contact your specialist dealer if the problem persists.
18-0A	Charger Start Error	<ol style="list-style-type: none"> 1 Restart system. 2 Switch off system. 3 Disconnect charger from system and socket. 4 Wait until the status LED goes out. 5 Check plug contacts on pedevec and charger and clean if necessary. 6 Plug charger into the socket again. 7 Plug charger into the system again and start system. 8 Contact your specialist dealer if the problem persists.

Table 129: List of display screen error messages

Code	Description	Method of resolution
18-0B	Lock Start Error	<ol style="list-style-type: none"> 1 Restart system. 2 Contact your specialist dealer if the problem persists.
19-xx	Remote Safety Error	<ol style="list-style-type: none"> 1 Start system. 2 Contact your specialist dealer if the problem persists.
1A-01	Tampering Detected	<ol style="list-style-type: none"> 1 Check speed sensor magnet position and check for manipulation. 2 Start system. 3 Contact your specialist dealer if the problem persists.
1A-02	Tampering Detected Speed sensor missing	<ol style="list-style-type: none"> 1 Check that the magnet and speed sensor are correctly positioned 2 Start system. 3 Contact your specialist dealer if the problem persists.
1B-xx	System Voltage Error	<ol style="list-style-type: none"> 1 Check that the correct battery has been inserted (36V/48V). 2 Start system. 3 Contact your specialist dealer if the problem persists.
1C-xx	Bluetooth Module Error	<ol style="list-style-type: none"> 1 Start system. 2 Re-start FIT E-Bike Control (app); update if necessary. 3 Contact your specialist dealer if the problem persists.
1D-xx	EMS mode active	<ol style="list-style-type: none"> 1 Start system. 2 Contact your specialist dealer if the problem persists.
1E-xx	OEM mode active	<ol style="list-style-type: none"> 1 Start system. 2 Contact your specialist dealer if the problem persists.
1F-xx	TEST mode active	<ol style="list-style-type: none"> 1 Start system. 2 Contact your specialist dealer if the problem persists.
20-xx	Reserve mode active (info text)	<ol style="list-style-type: none"> 1 Charge the battery. 2 Contact your specialist dealer if the problem persists.

Table 129: List of display screen error messages

Code	Description	Method of resolution
21-xx	Lock Error	<ol style="list-style-type: none"> 1 Start system. 2 Contact your specialist dealer if the problem persists.
22-xx	Full load cycle active	Battery is charged 100% for calibration purposes despite Long Life mode.
29-xx	Display Communication Error	<ol style="list-style-type: none"> 1 Start system. 2 Contact your specialist dealer if the problem persists.
23-09	Tyre Pressure Sensor Error Battery low, rear	▶ Contact specialist dealer. Sensor must be replaced shortly.
23-0A	Tyre Pressure Sensor Error Battery low, rear	▶ Contact specialist dealer. Sensor must be replaced shortly.
23-0B	Tyre Pressure Sensor Error Battery low, rear	▶ Contact specialist dealer. Sensor must be replaced shortly.
23-0C	Tyre Pressure Sensor Error Battery low, rear	▶ Contact specialist dealer. Sensor must be replaced shortly.
23-xx	Tyre Pressure Sensor Error Battery low, rear	▶ Contact specialist dealer. Sensor must be replaced shortly.
24-01	Charger Multi-Battery Error	<ol style="list-style-type: none"> 1 Recharge each battery individually. 2 Contact your specialist dealer if the problem persists.
25-xx	1Wire communication error	<ol style="list-style-type: none"> 1 Start system. 2 Contact your specialist dealer if the problem persists.
26-xx	Battery lock (ABUS) Error	<ol style="list-style-type: none"> 1 Start system. 2 Contact your specialist dealer if the problem persists.
29-xx	Display Communication Error	<ol style="list-style-type: none"> 1 Start system. 2 Contact your specialist dealer if the problem persists.

Table 129: List of display screen error messages

Code	Description	Method of resolution
2A-xx	Display Software Error	<ol style="list-style-type: none"> 1 Restart system. 2 Switch off system. 3 Remove display from mount, check contacts and clean if necessary. 4 Re-insert display and start system. 5 Contact your specialist dealer if the problem persists.
2B-xx	Display Authentication Error	<ol style="list-style-type: none"> 1 Restart system. 2 Switch off system. 3 Remove display from mount, check contacts and clean if necessary. 4 Re-insert display and start system. 5 Contact your specialist dealer if the problem persists.
2C-xx	Display Peripheral Error	<ol style="list-style-type: none"> 1 Start system. 2 Contact your specialist dealer if the problem persists.
2D-xx	Display Identification Error	<ol style="list-style-type: none"> 1 Restart system. 2 Switch off system. 3 Remove display from mount, check contacts and clean if necessary. 4 Re-insert display and start system. 5 Contact your specialist dealer if the problem persists.
2E-01	Display overheated Display brightness is reduced	<ol style="list-style-type: none"> 1 Ride bike to cool down display 2 Protect display against sunlight
48-xx	Motor Communication Error	<ol style="list-style-type: none"> 1 Check plug contacts on the battery and pedelec; clean if necessary. 2 Start system. 3 Contact your specialist dealer if the problem persists.
49-07	Motor Unit Error Battery not ready	<ol style="list-style-type: none"> 1 Switch off system. 2 Remove battery from mount, check contacts and clean if necessary. 3 Re-insert battery. 4 Start system. 5 Contact your specialist dealer if the problem persists.

Table 129: List of display screen error messages

Code	Description	Method of resolution
49-09, 49-0A	Motor Unit Error	<ol style="list-style-type: none"> 1 Check if one or both trigger buttons are being held down. If so, release buttons. 2 Start system. 3 Contact your specialist dealer if the problem persists.
49-0B	Motor Unit Error Change in sprocket detected	<ol style="list-style-type: none"> 1 Restart system. 2 Contact your specialist dealer if the problem persists.
49-0C	Motor Unit Error Tampering Detected	<ol style="list-style-type: none"> 1 Restart system. 2 Contact your specialist dealer if the problem persists.
49-0D	Motor Unit Error	<ol style="list-style-type: none"> 1 Restart system. 2 Check lighting cables and lights for short circuit. Check lamp fitted is compatible with the pedelec and replace if necessary. 3 Contact your specialist dealer if the problem persists.
49-xx	Motor Unit Error	<ol style="list-style-type: none"> 1 Restart system. 2 Contact your specialist dealer if the problem persists.
4A-xx	Motor Overheat	<ol style="list-style-type: none"> 1 Switch off system. 2 Allow motor to cool and clean motor ventilation slots if necessary. 3 Switch on system. 4 Contact your specialist dealer if the problem persists.
4B-xx	Motor Speed Sensor Error	<ol style="list-style-type: none"> 1 Start system. 2 Contact your specialist dealer if the problem persists.
4B-02	Motor Speed Sensor Manipulation	<ol style="list-style-type: none"> 1 Start system. 2 Check that the magnet and speed sensor are correctly positioned. 3 Contact your specialist dealer if the problem persists.
4C-01	Motor Torque Sensor Error	<ol style="list-style-type: none"> 1 Start system. 2 Contact your specialist dealer if the problem persists.

Table 129: List of display screen error messages

Code	Description	Method of resolution
4D-03	Gear Shift Error Relieve pressure on pedals	<ol style="list-style-type: none"> 1 Relieve pressure on pedals so that the pedelec can switch to the required push assist gear. 2 Wait 3 seconds. 3 Re-start system without applying pressure on the pedals. 4 Contact your specialist dealer if the problem persists.
4D-08	Gear Shift Error Stop. Relieve pressure on pedals	<ol style="list-style-type: none"> 1 Bring pedals to halt. 2 Relieve pressure on pedals. 3 Wait 3 seconds. 4 Re-start system without applying pressure on the pedals. 5 Start calibration on display gear shift menu (follow instructions). 6 Contact your specialist dealer if the problem persists.
4D-11	Gear Shift Error Gear shift blocked for 1 minute	<ol style="list-style-type: none"> 1 Wait 1 minute. 2 Restart system. 3 Contact your specialist dealer if the problem persists.
4D-xx	Gear Shift Error	<ol style="list-style-type: none"> 1 Relieve pressure on pedals. 2 Wait 3 seconds. 3 Re-start system without applying pressure on the pedals. 4 Start calibration on display gear shift menu (follow instructions). 5 Contact your specialist dealer if the problem persists.
4E-xx	Motor Cadence Sensor Error	<ol style="list-style-type: none"> 1 Start system. 2 Contact your specialist dealer if the problem persists.
4F-xx	Motor Authentication Error	<ol style="list-style-type: none"> 1 Start system. 2 Contact your specialist dealer if the problem persists.

Table 129: List of display screen error messages

Code	Description	Method of resolution
51-01 51-02	Motor Voltage Error Battery Voltage Error	<ol style="list-style-type: none"> 1 Start system. 2 Check lighting and its cabling for damage. 3 Contact your specialist dealer if the problem persists.
52-xx	Motor Angled Sensor Error	<ol style="list-style-type: none"> 1 Start system. 2 Contact your specialist dealer if the problem persists.
53-xx	Motor Software Error	<ol style="list-style-type: none"> 1 Start system. 2 Contact your specialist dealer if the problem persists.
67-01, 67-03, 67-06, 67-12	Battery Voltage Error	<ol style="list-style-type: none"> 1 Start system. 2 Contact your specialist dealer if the problem persists.
67-02, 67-07, 67-08, 67-09, 67-13	Battery Voltage Error	<ol style="list-style-type: none"> 1 Connect battery to the charger. 2 Start system. 3 Contact your specialist dealer if the problem persists.
69-05, 69-0A, 69-0B, 69-11, 69-15	Battery Voltage Error	<ol style="list-style-type: none"> 1 Start system. 2 Contact your specialist dealer if the problem persists.
68-01, 68-05, 68-06 68-07, 68-09, 68-16, 68-17, 68-18, 68-19, 68-1A	Battery Current Discharge Error	<ol style="list-style-type: none"> 1 Switch off system. 2 Remove the battery. 3 Insert the battery. 4 Start system. 5 Contact your specialist dealer if the problem persists.
68-02, 68-03, 68-08, 68-0A	Battery Current Error Charge Error	<ol style="list-style-type: none"> 1 Disconnect battery charger. 2 Connect charger. 3 Start charging. 4 Contact your specialist dealer if the problem persists.
68-04, 68-11, 68-12	Battery Current Error Short Circuit	<ol style="list-style-type: none"> 1 Switch off system. 2 Remove the battery. 3 Insert the battery. 4 Start system. 5 Contact your specialist dealer if the problem persists.

Table 129: List of display screen error messages

Code	Description	Method of resolution
68-0B, 68-13	Battery Current Error Overcurrent Error	<ol style="list-style-type: none"> 1 Switch off system. 2 Remove the battery. 3 Insert the battery. 4 Start system. 5 Contact your specialist dealer if the problem persists.
68-14	Battery Current Error Start error	<ol style="list-style-type: none"> 1 Switch off system. 2 Remove the battery. 3 Insert the battery. 4 Start system. 5 Contact your specialist dealer if the problem persists.
68-15	Battery Current Error	<ol style="list-style-type: none"> 1 Switch off system. 2 Remove the battery. 3 Insert the battery. 4 Start system. 5 Contact your specialist dealer if the problem persists.
69-01, 69-08	Battery Temperature Error	<ol style="list-style-type: none"> 1 Disconnect charger from the battery 2 Leave battery to cool down (> 60 minutes). 3 Start charging. 4 Contact your specialist dealer if the problem persists.
69-02, 69-09	Battery Temperature Error	<ol style="list-style-type: none"> 1 Switch off system. 2 Leave battery to cool down (> 60 minutes). 3 Start system. 4 Contact your specialist dealer if the problem persists.
69-03, 69-0C	Battery Temperature Error	<ol style="list-style-type: none"> 1 Take battery into warm environment. 2 Leave battery to warm up in warm environment (> 30 minutes). 3 Start charging. 4 Contact your specialist dealer if the problem persists.
69-04, 69-0D	Battery Temperature Error	<ol style="list-style-type: none"> 1 System is being operated below the permitted temperature 2 Leave battery to warm up in warm environment (> 30 minutes). 3 Start system. 4 Contact your specialist dealer if the problem persists.

Table 129: List of display screen error messages

Code	Description	Method of resolution
69-05, 69-0A, 69-0F, 69-11, 69-12	Battery Temperature Error	<ol style="list-style-type: none"> 1 Switch off system. 2 Leave battery to cool down (> 60 minutes). 3 Start system. 4 Contact your specialist dealer if the problem persists.
69-06, 69-0B, 69-10	Battery Temperature Error	<ol style="list-style-type: none"> 1 System is being operated below the permitted temperature 2 Leave battery to warm up in warm environment (> 30 minutes). 3 Start system. 4 Contact your specialist dealer if the problem persists.
69-13	Battery Temperature Error	<ol style="list-style-type: none"> 1 Start system. 2 Contact your specialist dealer if the problem persists.
6A-xx	Battery Software Error	<ol style="list-style-type: none"> 1 Check that the correct battery has been inserted (36 V/48 V). 2 Check plug contacts on pedecec and charger and clean if necessary. 3 Start system. 4 Contact your specialist dealer if the problem persists.
6B-xx	Battery Hardware Error	<ol style="list-style-type: none"> 1 Start system. 2 Contact your specialist dealer if the problem persists.
6C-xx	Battery Communication Error	<ol style="list-style-type: none"> 1 Check whether the original battery has been inserted. 2 Check plug contacts on the battery and pedecec; clean if necessary. 3 Start system. 4 Contact your specialist dealer if the problem persists.
6D-xx	Battery Authentication Error	<ol style="list-style-type: none"> 1 Check whether the original battery has been inserted. 2 Check plug contacts on the battery and pedecec; clean if necessary. 3 Start system. 4 Contact your specialist dealer if the problem persists.

Table 129: List of display screen error messages

Code	Description	Method of resolution
6D-xx	Unknown Battery Error	<ol style="list-style-type: none"> 1 Check that the correct battery has been inserted (36 V/48 V). 2 Check plug contacts on pedecec and charger and clean if necessary. 3 Start system. 4 Contact your specialist dealer if the problem persists.
FF-xx	Battery Start Error	<ol style="list-style-type: none"> 1 Start system. 2 Contact your specialist dealer if the problem persists.
86-xx	Speednode Software Error	<ol style="list-style-type: none"> 1 Start system. 2 Contact your specialist dealer if the problem persists.
87-xx	Speednode Authentication Error	<ol style="list-style-type: none"> 1 Start system. 2 Contact your specialist dealer if the problem persists.
95-xx	Charger Software Error	<ol style="list-style-type: none"> 1 Check that the correct battery has been inserted (36 V/48 V). 2 Disconnect charger from system and socket. 3 Wait until the status LED goes out. 4 Plug charger into the socket. 5 Connect charger to the mains. 6 Contact your specialist dealer if the problem persists.
96-xx	Charger Voltage Error	<ol style="list-style-type: none"> 1 Check that the correct battery has been inserted (36 V/48 V). 2 Disconnect charger from system and socket. 3 Wait until the status LED goes out. 4 Plug charger into the socket. 5 Connect charger to the mains. 6 Contact your specialist dealer if the problem persists.

Table 129: List of display screen error messages

Code	Description	Method of resolution
97-xx	Charger Charging Current Error	<ol style="list-style-type: none"> 1 Check that the correct battery has been inserted (36 V/48 V). 2 Disconnect charger from system and socket. 3 Wait until the status LED goes out. 4 Plug charger into the socket. 5 Connect charger to the mains. 6 Contact your specialist dealer if the problem persists.
98-xx	Charger Temperature Error	<ol style="list-style-type: none"> 1 Disconnect charger from battery. 2 Leave charger to cool down (> 30 minutes). 3 Start charging. 4 Contact your specialist dealer if the problem persists.
8B-xx	Gear Shift Authentication Error	<ol style="list-style-type: none"> 1 Start system. 2 Contact your specialist dealer if the problem persists.
8C-06	Gear shift Hardware Error Calibration required	<ol style="list-style-type: none"> 1 Carry out gear shift calibration as per the instructions in the operating instructions. 2 Contact your specialist dealer if the problem persists.
8C-xx	Gear Shift Hardware Error	<ol style="list-style-type: none"> 1 Start system. 2 Contact your specialist dealer if the problem persists.
9A-xx	Lock Authentication Error	<ol style="list-style-type: none"> 1 Check that an original FIT lock is installed. 2 Start system. 3 Contact your specialist dealer if the problem persists.
9B-xx	Lock blocked	<ol style="list-style-type: none"> 1 Start system. 2 Contact your specialist dealer if the problem persists.
9C-xx	Lock Hardware Error	<ol style="list-style-type: none"> 1 Start system. 2 Check lock for damage. 3 Contact your specialist dealer if the problem persists.
9D-xx	Lock Movement Detected	<ol style="list-style-type: none"> 1 Re-send lock command. 2 Start system. 3 Check lock for damage. 4 Contact your specialist dealer if the problem persists.

Table 129: List of display screen error messages

9.2.5.2 UltraCore battery

In the event of a hazard, a protective circuit switches the battery off automatically.

If a battery fault is detected, the LEDs on the Charge Level indicator will flash.





Description	Method of resolution
<p>Code: </p> <p>Permanent error The battery has a permanent error.</p>	<ol style="list-style-type: none"> 1 Replace the battery. <p>The battery is classified as having an unknown defect in this condition and must not be transported by mail or air.</p> <ol style="list-style-type: none"> 2 Contact specialist dealer.
<p>Code: </p> <p>Charge error The battery has been overcharged and the charger may have a fault.</p>	<ol style="list-style-type: none"> 1 Contact specialist dealer.
<p>Code: </p> <p>Current and cell errors There may be a fault in the motor or charger, or the battery may have gone into deep discharge.</p>	<ol style="list-style-type: none"> 1 Contact specialist dealer.
<p>Code: </p> <p>Temperature error The battery is outside the permitted temperature range.</p>	<ol style="list-style-type: none"> 1 Allow battery to warm up slowly in warm environment or cool down in a cool environment. 2 Switch on system. 3 If flashing persists after the battery has not been used for a long time, it needs replacing. <p>The battery is classified as having an unknown defect in this condition and must not be transported by mail or air.</p> <ol style="list-style-type: none"> 4 Contact specialist dealer.

Table 130: List of battery error messages

Description	Method of resolution
<p>Code: </p> <p>Temperature error An authentication error may have occurred.</p>	<ol style="list-style-type: none"> 1 Check the battery connections for dirt and clean if necessary. 2 Contact your specialist dealer if the problem persists.

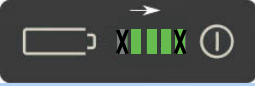
Table 130: List of battery error messages

9.2.5.3 Operating element

There is a status LED on the operating element in the navigation button.

Colour	Flash sequence	Status
GREEN	Lights up	<ol style="list-style-type: none"> 1 Connect system to maintenance tool at the specialist dealer's.
RED	Lights up	<ol style="list-style-type: none"> 1 Start system. 2 If the remote continues to light up red, have the component replaced at the specialist dealer's.
RED	Flashes	<ol style="list-style-type: none"> 1 Start system. 2 If the remote continues to light up red, have the component replaced at the specialist dealer's.

Table 131: Operating element status light

9.2.6 Correcting disc brake faults

Symptom	Cause	Remedy
Ringing and unusual sounds from disc brakes.	Riding on asphalt with off-road tyres.	▶ Contact specialist dealer. Fit a city or trekking tyre.
Low braking power from the disc brake.	Dirty or greasy brake disc.	▶ Clean brake disc thoroughly with white spirit or brake cleaner.
	Worn brake disc.	▶ Contact specialist dealer. New brake disc.
	Worn brake lining.	▶ Contact specialist dealer. New brake linings.
	Brake lining vitrification.	
Metallic noises from disc brake.	Worn brake linings.	▶ Contact specialist dealer. New brake linings and brake disc.
Spongy, soft or poor pressure point in disc brakes.	Brake calliper fitted incorrectly, brake disc loose, brake disc or brake lining worn or brake system leaking.	▶ Contact specialist dealer.
Noises when a disc brake is applied.	Dirt.	1 Clean brake disc and brake thoroughly. 2 If the problem is not solved, contact your specialist dealer.
	Worn or wrong brake linings.	▶ Contact specialist dealer. New brake linings and brake discs.
	Wheel, hub or axle fitted incorrectly.	▶ Contact specialist dealer. Check brake system and wheel assembly.
	Brake calliper and/or brake disc fitted incorrectly.	
	Incorrect torques.	
	Brake disc damaged by side impact.	
	Vitrified brake linings.	
	Brake system leaking.	
Incorrect brake mount height.		

Table 132: Disc brake error solution

9.2.7 Correcting faults in the SR SUNTOUR suspension fork

9.2.7.1 Rebound too fast

The suspension fork rebounds too quickly, producing a "pogo stick" effect, where the wheel lifts from the ground in an uncontrolled way. This impairs traction and control (blue line).

Fork head and handlebars are deflected upwards if the wheel bounces back from the ground. Body weight may be thrown up and back in an uncontrolled way (green line).



Figure 191: Suspension fork rebounding too quickly

Solution

► Turn **rebound adjuster (fork)** clockwise.

⇒ The rebound speed is decreased (slower return).



Figure 192: Example of SR SUNTOUR rebound adjuster (fork) (1)

9.2.7.2 Rebounding too slowly

The fork does not rebound quickly enough after absorbing a bump. The fork also remains deflected over subsequent bumps, which reduces deflection and increases the hardness of impacts. Available deflection, traction and control decrease (blue line).

The fork remains in a deflected state, causing the headset and handlebars to move to a lower position. Body weight is shifted forward after the impact (green line).

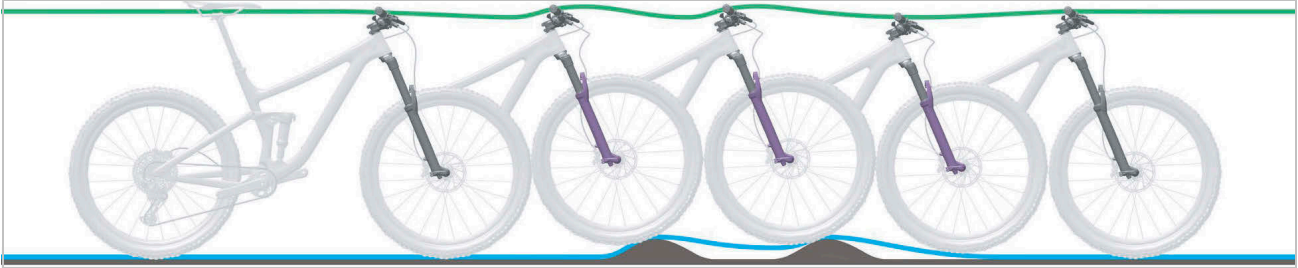

Figure 193: Suspension fork rebounding too slowly

Solution

► Turn **rebound adjuster (fork)** anti-clockwise.

⇒ The rebound speed is increased (faster return).



Figure 194: Example of SR SUNTOUR rebound adjuster (fork) (1)

9.2.7.3 Suspension too soft on inclines

The fork deflects at a low point in the terrain. The deflection is quickly used up, body weight shifts forward and the pedelec loses some momentum.

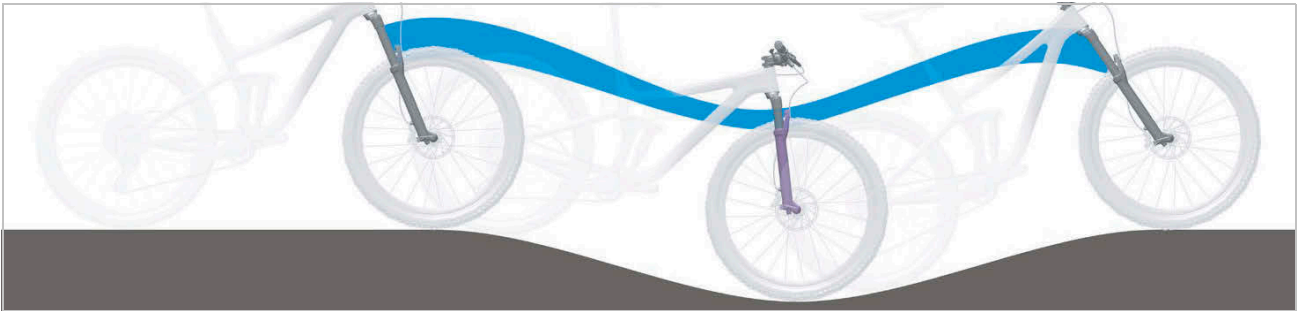

Figure 195: Excessively soft suspension in the suspension fork on hilly terrain

Solution

- ▶ Turn **compression lever** clockwise towards **LOCK**.

⇒ The damping and compression hardness are increased and the deflection stroke speed. Efficiency on hilly and flat terrain is improved.

R2C2-PCS R2C2 RC2 RC2-PCS	RC-PCS RC	RLRC-PCS RLRC	LORC-PCS LORC

Table 133: Low-speed lever (1) on the SR Suntour suspension fork on the fork crown

9.2.7.4 Excessively hard damping on bumps

When the bike hits a bump, the fork deflects too slowly and the wheel lifts up from the bump. Traction decreases when the wheel no longer touches the ground.

The headset and handlebars are deflected upwards significantly, which can impair control.

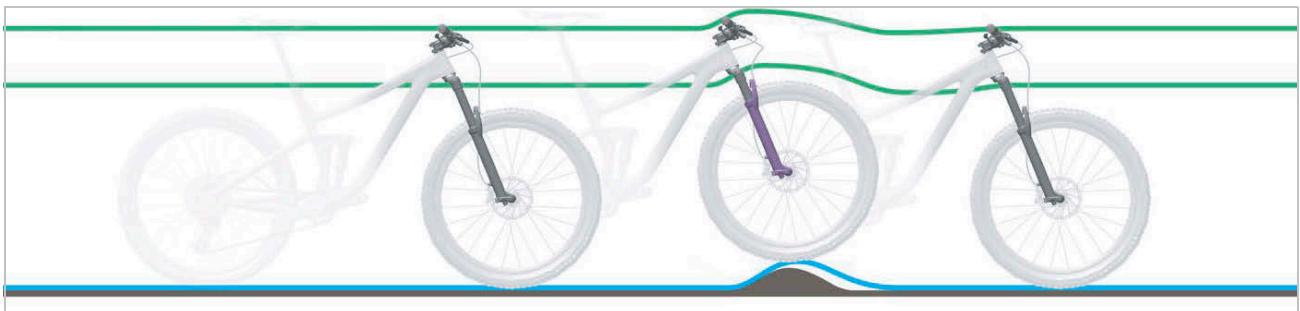

Figure 196: Excessively hard damping in the suspension fork on bumps

Solution

► Turn **compression lever** clockwise towards OPEN.

⇒ The damping and compression hardness reduces and the deflection stroke speed is reduced. Sensitivity to small bumps is increased.

R2C2-PCS R2C2 RC2 RC2-PCS	RC-PCS RC	RLRC-PCS RLRC	LORC-PCS LORC

Table 134: Low-speed lever (1) on the SR Suntour suspension fork on the fork crown

9.2.8 Correcting faults in the ROCKSHOX rear frame damper

9.2.8.1 Rebound too fast

The rear frame damper rebounds too quickly, producing a "pogo stick" effect or causing the bike to bounce after the wheel hits a bump and lands on the ground again. This impairs traction and control due to the uncontrolled speed at which the damper rebounds after deflecting (blue line).

Saddle and handlebars are deflected upwards when the wheel bounces back from the ground. The rider's body weight may be shifted upwards and forwards if the damper fully rebounds too quickly (green line).



Figure 197: Rear frame damper rebounding too quickly

Solution

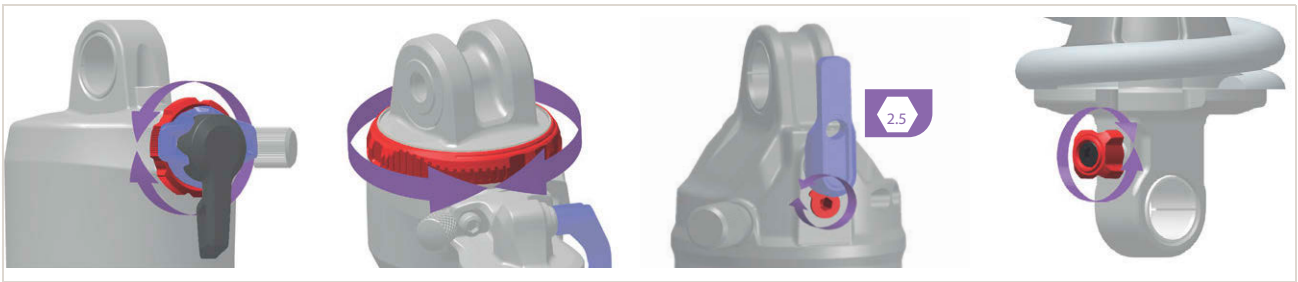

Figure 198: Position and shape of the rebound adjuster (rear frame damper) (red) depends on the model

- ▶ Turn **rebound adjuster (rear frame damper)** clockwise.
- ⇒ Rebound damping is increased. The rebound speed is reduced and traction and control is increased.

9.2.8.2 Rebounding too slowly

The rear frame damper does not rebound quickly enough after a bump has been compensated and is not in the required initial position when the wheel hits the next bump. The rear frame damper remains compressed during successive bumps, thus reducing deflection and ground contact and increasing hardness on the next impact. The rear wheel bounces off the second bump since the rear frame damper does not rebound quickly enough to make contact with the ground and return to the initial position again. The available deflection and traction are reduced (blue line).

The rear frame damper remains in a deflected state after contact with the first bump. When the rear wheel hits the second bump, the saddle follows the path of the rear wheel instead of remaining in a horizontal position. The available deflection and potential absorption of bumps are reduced, which causes instability and loss of control during successive bumps (green line).

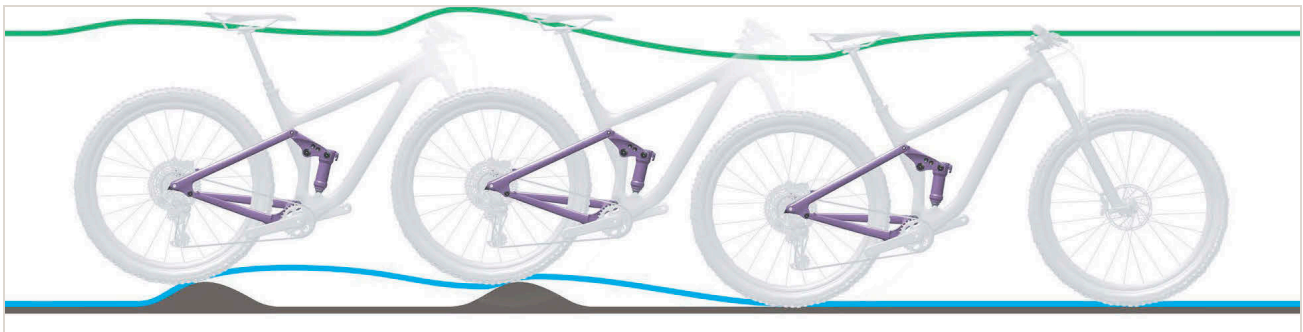

Figure 199: Rear frame damper rebounding too slowly

Solution

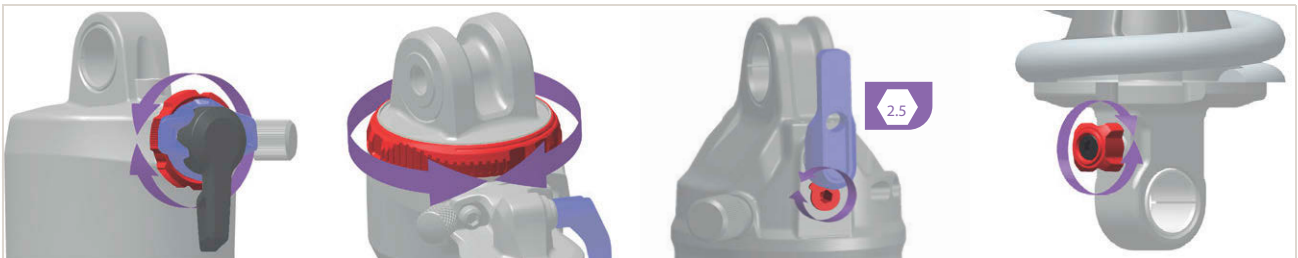

Figure 200: Position and shape of the rebound adjuster (red) depends on the model

- ▶ Turn **rebound adjuster** in an anti-clockwise direction.
- ⇒ Rebound damping is reduced. The rebound speed is increased. Performance while riding over bumps is improved.

9.2.8.3 Suspension too soft on inclines

The rear frame damper deflects deeply through the deflection range. Deflection is quickly used up,

to the pedelec rider's weight shifts forward and the pedelec loses some momentum.



Figure 201: Excessively soft suspension in the rear frame damper on hilly terrain

Solution

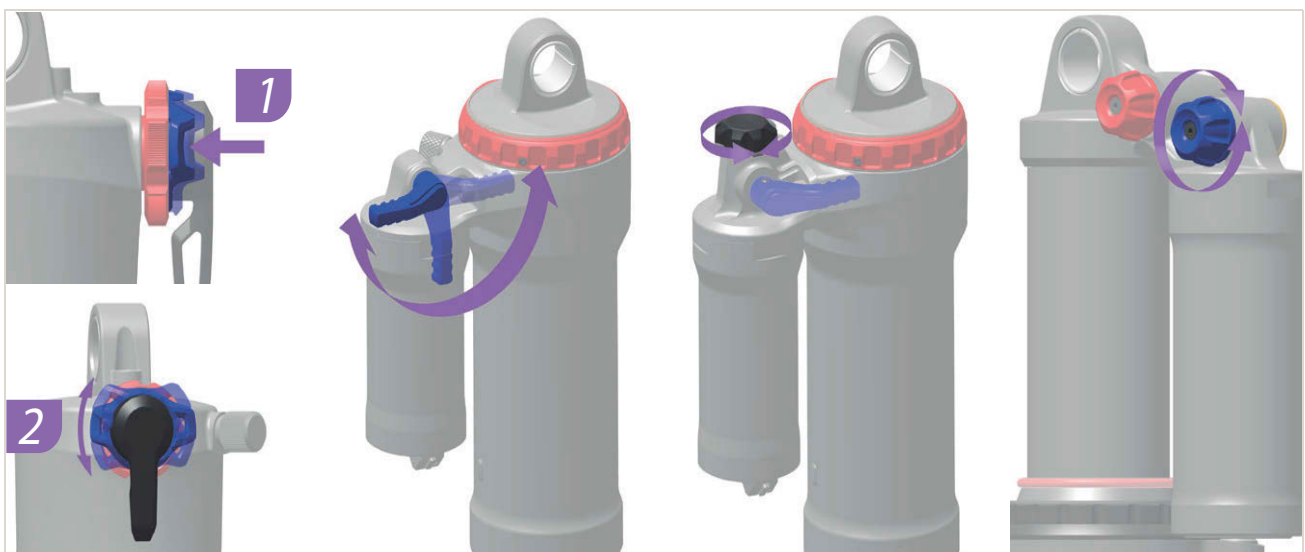

Figure 202: Position and shape of the compression adjuster (blue) depends on the model

- ▶ Turn the **compression adjuster** clockwise.
- ⇒ The damping and compression stroke hardness is increased while the deflection stroke speed is reduced.

9.2.8.4 Excessively hard damping on bumps

When the bike hits a bump, the damper deflects too slowly and the rear wheel lifts up from the bump. Traction is reduced (blue line).

Saddle and pedelec rider are deflected upwards and forwards, the rear wheel loses contact with the ground and control is reduced (green line).



Figure 203: Excessively hard damping in the rear frame damper on bumps

Solution

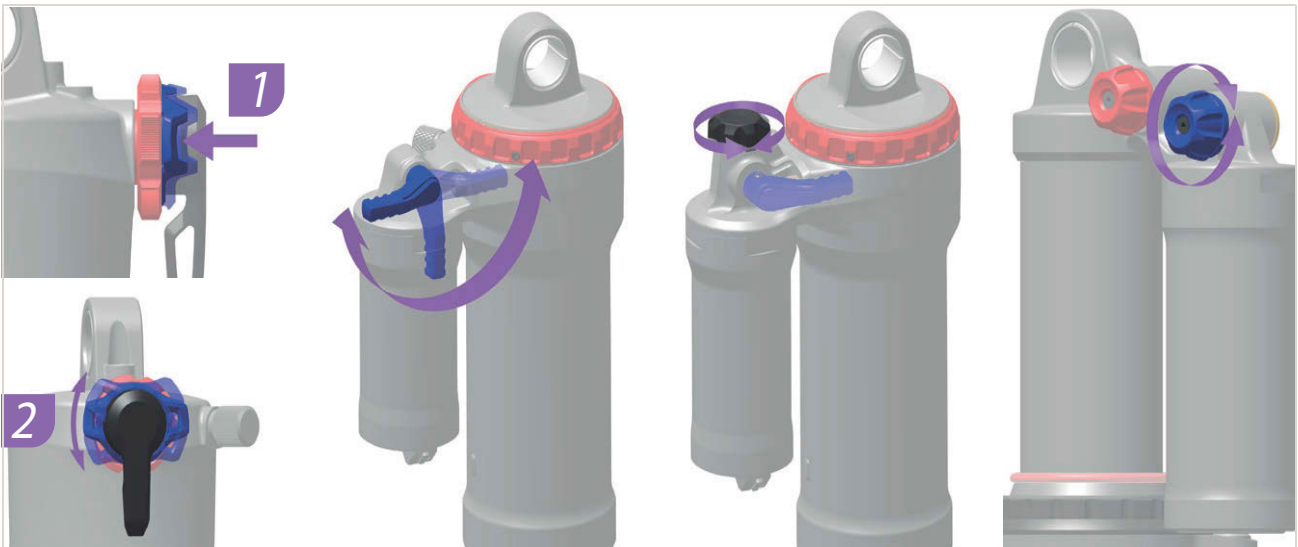

Figure 204: Position and shape of the compression adjuster (blue) depends on the model

- ▶ Turn the **compression adjuster** anti-clockwise.
- ⇒ The damping and compression stroke hardness is reduced and the deflection stroke speed is increased. Sensitivity to small bumps is increased.

9.2.9 Correcting freewheel faults

Symptom	Cause	Remedy
Freewheel blocked.	Cover forgotten after fitting.	▶ Contact specialist dealer. Check installation correct.
	After fitting, socket was compressed by over-tightening the quick-release axle.	▶ Contact specialist dealer. Measure the length of the socket. If the socket is shorter than 15.4 mm, replace socket.
Freewheel does not lock into place or slips.	After maintenance: Too much or wrong grease on the toothed discs.	▶ Contact specialist dealer. Remove hub. Clean and grease toothed disc.
	Toothed discs are worn.	▶ Contact specialist dealer. Replace toothed disc.
	One or both springs were forgotten after fitting.	▶ Contact specialist dealer. Check installation correct.
	One or both toothed discs are fitted the wrong way round after assembly.	▶ Contact specialist dealer. Check installation correct.
Hub has axial clearance.	Ball bearings are worn.	▶ Contact specialist dealer. Replace ball bearings.
	One or both toothed discs are fitted the wrong way round after assembly.	▶ Contact specialist dealer. Check installation correct.
Hub is stiff when turned.	Ball bearings are worn.	▶ Contact specialist dealer. Replace ball bearings.
	Ball bearings have been driven in too firmly after assembly	▶ Contact specialist dealer. Check installation correct.
	Installation sequence for ball bearings not observed.	▶ Contact specialist dealer. Check installation correct.
Hub makes noise.	Ball bearings are worn.	▶ Contact specialist dealer. Replace ball bearings.
Cassette caused notches on the freewheel body.	Steel cassette works its way into the aluminium bar on the freewheel body.	▶ Contact specialist dealer. Remove notches on the cassette surface with a file.
Freewheel body is stiff when turned.	Ball bearings in the freewheel body are worn.	▶ Contact specialist dealer. Replace freewheel body.
Freewheel is too loud or too quiet.	Perception of freewheel noise is subjective. While some pedelec riders prefer loud freewheel noise, others like a quite freewheel more.	▶ This is not a malfunction. The amount of grease between the toothed discs may have an effect on the freewheel noise. Less grease increases freewheel noise but also causes greater wear.

Table 135: Error solution for freewheel

9.2.10 Correcting lighting faults

Symptom	Cause	Remedy
The front light or rear light does not go on, even when the switch is pressed.	The default settings in the electric drive system have probably been configured incorrectly. The light is defective.	<ol style="list-style-type: none"> 1 Take pedelec out of service immediately. 2 Contact specialist dealer.

Table 136: Lighting fault solution

9.2.11 Correcting faults in tyres

Symptom	Cause	Remedy
Valve torn off.	Presta valve used with a sizeable valve hole. The hole's metal edge separates the valve stem from the tube.	► Contact specialist dealer. Fit another type of valve.

Table 137: Fault solution for tyres

9.2.12 Correcting control seat post faults

Symptom	Cause	Remedy
Seat post clicks or creaks.	Protective layer missing.	► Service seat post (see Section 7.4.9).
Seat post deflects and bobs periodically.	Incorrect preload.	► Adjust preload so that the suspension seat post does not compress under the rider's weight when at rest.
Seat post with remote control does not rise or lower.	Bowden cable is not tensioned correctly.	<p>► Adjust the Bowden cable with the setting screw (1) on the remote control.</p>  <p>Figure 205: Remote control with setting screw (1)</p> <ul style="list-style-type: none"> • Reduce sensitivity: turn the setting screw clockwise. • Increase sensitivity: turn setting screw anti-clockwise.

Table 138: Fault solution for the seat post

9.2.13 Correcting other faults and errors

Symptom	Cause	Remedy
Two beeps will sound if a switch is pressed but the switch cannot be operated.	Pressed switch mode has been deactivated.	▶ This is not a malfunction.
Three beeps are sounded.	A fault or warning has occurred.	▶ This occurs when a warning or an error is shown on the on-board computer. Follow the instructions for the code in Section 6.2 System Messages.
If an electronic gear shift is used, pedal assistance becomes less effective when the gear is changed.	This is because the computer sets the pedal assistance to the optimum level.	▶ This is not a malfunction.
A noise can be heard after switching.		▶ Contact specialist dealer.
It is normal to hear a noise coming from the rear wheel when cycling as normal.	The gear shift setting may not have been made properly.	▶ Contact specialist dealer.
If the pedelec is brought to a stop the pedelec, the gear transmission does not switch to the position pre-configured in the functional feature.	You may have applied too much pressure on the pedals.	▶ Press on the pedals only gently to make it easier to change the transmission.

Table 139: Other drive system errors

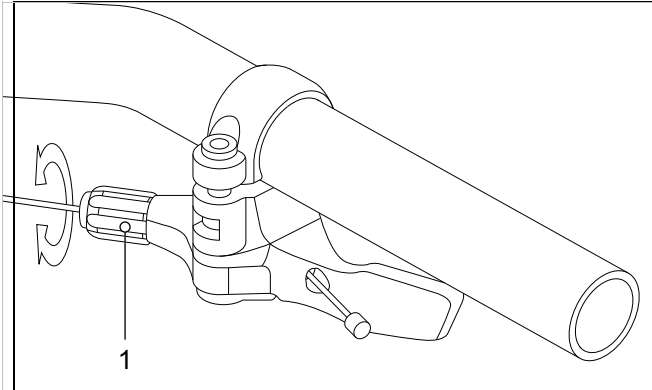

9.3 Repairs at the specialist dealer

Expert knowledge and special tools are required for many repairs. For this reason, repairs may only be carried out at a specialist dealer. These include:

- Replacing tyre, tube and spokes
- Replace brake linings, rims and brake discs
- Replace and tension the chain.

9.3.1 Original parts and lubricants

The individual pedelec parts have been carefully selected and matched to one other.

Only original parts and lubricants must be used for inspection and repair.

The constantly updated accessory approval and parts lists are in Section 11, Documents and Drawings.

- ▶ Follow the operating instructions for the new components.

9.3.2 Repairing the frame

9.3.2.1 Removing paint damage on frame

- 1 Gently sand paintwork damage with 600-grit sandpaper.
- 2 Smooth edges.
- 3 Apply one or two coats of repair paint.

9.3.2.2 Removing damage from impact on the carbon frame

There may be damage to the laminate beneath the paintwork in the case of impact. The frame may break even under light stress.

- 1 Take pedelec out of service.
- 2 Send frame to a fibre composite repair company or purchase new frame as specified in the parts list.

9.3.3 Repairing the suspension fork

9.3.3.1 Removing paint damage on the fork

- 1 Gently sand paintwork damage with 600-grit sandpaper.
- 2 Smooth edges.
- 3 Apply one or two coats of repair paint.

9.3.3.2 Removing damage from impact on the carbon frame

There may be damage to the laminate beneath the paintwork in the case of impact. The fork may break even under light stress.

- ▶ Take pedelec out of service. New fork as specified in the parts list.

⇒ The fork must be free from any defects.

- 4 Clean inside and exterior.
- 5 Grease fork.
- 6 Install fork.

9.3.3.3 Repairing the seat post

Repairing paint damage on the seat post.

- 1 Gently sand paintwork damage with 600-grit sandpaper.
- 2 Smooth edges.
- 3 Apply one or two coats of repair paint.

9.3.3.4 Repairing damage from impact on the carbon seat post

There may be damage to the laminate beneath the paintwork in the case of impact. The carbon seat post may break even under light stress.

- 1 Take pedelec out of service.
- 2 New carbon seat post as specified in parts list.



9.3.4 Replacing the riding light

- ▶ Only use components in the corresponding power class for replacement.

9.3.5 Adjusting the headlight

- ▶ The *headlight* must be positioned so that its light beam shines on the road 10 m in front of the pedelec (see Section 6.4).

9.3.6 Checking suspension fork-tyre clearance

The tyre clearance needs to be checked each time a suspension fork tyre is replaced.

- 1 Release pressure from the suspension fork.
- 2 Press suspension fork together fully.
- 3 Measure the gap between the top of the tyre and the fork crown's lower surface. The gap must not be less than 10 mm. If the tyre is too large, the tyre will touch the lower surface of the fork crown when the fork is fully pressed together.
- 4 Release pressure on the suspension fork and pump it up again if it is an air suspension fork.
- 5 Take into account the fact that the gap will be smaller if there is a guard. Check again to ensure that there is sufficient clearance for the tyre.

10 Recycling and disposal



This device is marked according to the European Directive 2012/19/EU on waste electrical and electronic equipment – WEEE and the European



Directive 2006/66/EC on accumulators. The directive provides the framework for the return and recycling of used devices

across the EU. Consumers are legally required to return all used batteries of any type. It is forbidden to dispose of batteries in domestic waste.

The battery manufacturer is legally obliged to take back used and old batteries free of charge according to Section 9 German Batteries Act. The pedelec frame, battery, motor, on-board computer and charger are recyclable materials. You must dispose of and recycle them separately from the domestic waste in compliance with applicable statutory regulations. Separate collection and

recycling saves reserves of raw materials and ensures that all the regulations for protection of health and the environment are adhered to when recycling the product and/or the battery.

- ▶ Never dismantle the pedelec, battery or charger for disposal.

The pedelec, on-board computer, the unopened and undamaged battery and the charger can be returned to any specialist dealer free of charge. Further disposal options may be available, depending on the region.

- ▶ Store the individual parts of the decommissioned pedelec in a dry place, free from frost, where they are protected from direct sunlight.

10.1 Guidelines on removal of waste

Waste type	Disposal
Non-hazardous waste	
Waste paper, cardboard	Return paper collection bin, paper container, undamaged transport packaging to suppliers
Scrap metal and aluminium	Take to municipal collection points or have collected by waste disposal companies
Tyres, tubes	Tyre manufacturers' collection points, collection forms and fax templates available from tyre manufacturer Otherwise, residual waste bin (grey bin)
Fibre composite components (e.g. carbon, GRP)	Large carbon components such as defective frames and carbon rims can be sent to special collection points for recycling; see www.cfk-recycling.de/index.php?id=57
Dual system sales packaging made of plastic, metal and composite material, lightweight packaging	Collection by waste disposal firm where applicable; return transport packaging to suppliers Plastic waste bin (yellow bin)
CDs, DVDs	Take to municipal collection points since they are made of high-grade plastic and are easy to recycle Otherwise, residual waste bin (grey bin)

Table 140: Removal of waste guidelines

Waste type	Disposal
Dispose of	
Residual waste	Residual waste bin (grey bin)
Biodegradable lubricants Biodegradable oils Cleaning cloths covered in biodegradable oil	Residual waste bin (grey bin)
Filament lamps, halogen lamps	Residual waste bin (grey bin)
Hazardous waste	
 Recycling	
Batteries, rechargeable batteries	Return to the battery manufacturer.
Electric devices: Motor On-board computer Display Control panel Wiring	Take to a municipal collection point for electronic waste
Dispose of	
Waste oil Cleaning cloths daubed in oil Lubrication oil Gear oil Lubricating grease Cleaning fluids Kerosene White spirit Hydraulic fluid Brake fluid	<p>Never mix different oil fluids. Store in original container</p> <p>Small amounts (mainly <30 kg) Take to municipal collection points for hazardous waste (e.g. mobile toxic waste collection service)</p> <p>Larger quantities (>30 kg) Collection by waste disposal companies</p>
Paints Varnishes Thinners	Take to municipal collection points for hazardous waste (e.g. mobile toxic waste collection service)
Neon lights, energy-saving lamps	Take to municipal collection points for hazardous waste (e.g. mobile toxic waste collection service)

Table 140: Removal of waste guidelines



11 Documents

11.1 Assembly report

Date:

Frame number:

Components	Description	Tests	Criteria		Measures if rejected
			Acceptance	Rejection	
Front wheel	Assembly		O.K.	Loose	Adjust quick release
Kickstands	Check mount fastening	Functional check	O.K.	Loose	Retighten screws
Tyres		Tyre pressure check	O.K.	Tyre pressure too low/ too high	Adjust tyre pressure
Frame	Check for damage – fracture, scratches		O.K.	Damage detected	<i>Take out of operation</i> , new frame
Handles, coverings	Check mount fastening		O.K.	Not provided	Retighten screws, new handles and coverings as specified in parts list
Handlebars, stem	Check mount fastening		O.K.	Loose	Retighten screws; new stem as specified in parts list if necessary
Steering headset	Check for damage	Functional check	O.K.	Loose	Retighten screws
Saddle	Check mount fastening		O.K.	Loose	Retighten screws
Seat post	Check mount fastening		O.K.	Loose	Retighten screws
Guard	Check mount fastening		O.K.	Loose	Retighten screws
Pannier rack	Check mount fastening		O.K.	Loose	Retighten screws
Attachments	Check mount fastening		O.K.	Loose	Retighten screws
Bell		Functional check	O.K.	No ring, too quiet, missing	New bell as specified in the parts list
Suspension elements					
Fork, suspension fork	Check for damage		O.K.	Damage detected	New fork as specified in the parts list
Rear frame damper	Check for damage		O.K.	Damage detected	New fork as specified in the parts list
Suspension seat post	Check for damage		O.K.	Damage detected	New fork as specified in the parts list
Brake system					
Handbrake	Check mount fastening		O.K.	Loose	Retighten screws
Brake fluid	Check fluid level		O.K.	Too little	Refill with brake fluid; new brake hoses if damaged
Brake linings	Check brake linings, brake discs and rims for damage		O.K.	Damage detected	New brake linings, brake discs and rims
Back-pedal brake braking armature	Check mount fastening		O.K.	Loose	Retighten screws
Lighting system					
Rechargeable battery	First examination		O.K.	Error message	<i>Take out of service</i> ; contact battery manufacturer, new battery
Light cabling	Connections, correct wiring		O.K.	Cable defective, no light	New cabling
Rear light	Side light	Functional check	O.K.	No constant light	<i>Take out of service</i> ; new rear light as specified in parts list; replace if necessary
Front light	Side light, daytime riding light	Functional check	O.K.	No constant light	<i>Take out of service</i> ; new front light as specified in parts list; replace if necessary
Reflectors	All complete, state, fastening		O.K.	Damaged or not all complete	New reflectors



Components	Description		Criteria		Measures if rejected
	Assembly /inspection	Tests	Acceptance	Rejection	
Drive/gear shift					
Chain/cassette/sprocket/chainring	Check for damage		O.K.	Damage	Refasten if necessary or replace as specified in parts list
Chain guard/spoke guard	Check for damage		O.K.	Damage	Replace as specified in parts list
Bottom bracket axle/crank	Check mount fastening		O.K.	Loose	Retighten screws
Pedals	Check mount fastening		O.K.	Loose	Retighten screws
Shifter	Check mount fastening	Functional check	O.K.	Loose	Retighten screws
Shift cables	Check for damage	Functional check	O.K.	Loose and defective	Adjust shift cables; new shift cables if necessary
Front derailleur	Check for damage	Functional check	O.K.	Switching gears difficult or not possible	Adjust
Rear derailleur	Check for damage	Functional check	O.K.	Switching gears difficult or not possible	Adjust
Electric drive					
On-board computer	Check for damage	Functional check	O.K.	No screen, defective screen display	Restart, test battery, new software or new on-board computer; <i>take out of service</i>
Control panel	Control panel Check for damage	Functional check	O.K.	No response	Restart; contact control panel manufacturer, new control panel
Tachometer		Speed measurement	O.K.	Pedelec travelling 10% too fast/slow	Take pedelec out of service until the source of the error is found
Cabling	Visual inspection		O.K.	Failure in system, damage, kinked cables	New cabling
Battery mount	Firmly in position, lock, contacts	Functional check	O.K.	Loose; lock doesn't close, no contacts	New battery mount
Motor	Visual inspection and mount		O.K.	Damage, loose	Refasten motor, contact motor manufacturer, new motor
Software	Check version		In latest version	Not latest version	Import update

Technical inspection, checking safety, test ride

Components	Description		Criteria		Measures if rejected
	Assembly /inspection	Tests	Acceptance	Rejection	
Brake system		Functional check	O.K.	No full braking; braking distance too long	Locate defective part in brake system and correct
Gear shift under operating load		Functional check	O.K.	Problems when shifting gear	Readjust gear shift
Suspension components (fork, shock absorber, seat post)		Functional check	O.K.	Suspension too deep or no longer exists	Locate defective component and correct
Electric drive system		Functional check	O.K.	Loose connection, problems when riding, accelerate	Locate faulty components in electric drive and remedy
Lighting system		Functional check	O.K.	No continuous light, not bright enough	Locate defective part in lighting system and correct
Test ride			No strange noises	Strange noises	Locate source of noise and correct

Date:	
Fitter's name:	
Final inspection by workshop manager:	



11.2 Inspection and maintenance log

Diagnosis and documentation of current status

Date:

Frame number:

Component	Frequency	Description			Criteria		Measures if rejected
		Inspection	Test		Acceptance	Rejection	
Front wheel	6 months	Assembly			O.K.	Loose	Adjust quick release
Kickstands	6 months	Check mount fastening	Functional check		O.K.	Loose	Retighten screws
Tyres	6 months		Tyre pressure check		O.K.	Tyre pressure too low/ too high	Adjust tyre pressure
Frame	6 months	Check for damage – fracture, scratches			O.K.	Damage detected	Take pedelec out of service, new frame
Handles, coverings	6 months	Wear; check if fastened securely			O.K.	Not provided	Retighten screws, new handles and coverings as specified in parts list
Handlebars, stem	6 months	Check mount fastening			O.K.	Loose	Retighten screws; new stem as specified in parts list if necessary
Steering headset	6 months	Check for damage	Functional check	Lubricating and adjustment	O.K.	Loose	Retighten screws
Saddle	6 months	Check mount fastening			O.K.	Loose	Retighten screws
Seat post	6 months	Check mount fastening			O.K.	Loose	Retighten screws
Guard	6 months	Check mount fastening			O.K.	Loose	Retighten screws
Pannier rack	6 months	Check mount fastening			O.K.	Loose	Retighten screws
Attachments	6 months	Check mount fastening			O.K.	Loose	Retighten screws
Bell	6 months		Functional check		O.K.	No ring, too quiet, missing	New bell as specified in the parts list
Suspension elements							
Fork, suspension fork	To manufacturer's specifications*	Check for damage, corrosion, fracture		Maintenance as specified by manufacturer Lubrication, oil change as specified by manufacturer	O.K.	Damage detected	New fork as specified in the parts list
Rear frame damper	To manufacturer's specifications*	Check for damage, corrosion, fracture		Maintenance as specified by manufacturer Lubrication, oil change as specified by manufacturer	O.K.	Damage detected	New fork as specified in the parts list
Suspension seat post	To manufacturer's specifications*	Check for damage		Maintenance as specified by manufacturer	O.K.	Damage detected	New fork as specified in the parts list



Component	Frequency	Description			Criteria		Measures if rejected
		Inspection	Test		Acceptance	Rejection	
Brake system							
Handbrake	6 months	Check mount fastening			O.K.	Loose	Retighten screws
Brake fluid	6 months	Check fluid level		Depending on time of year	O.K.	Too little	Top up brake fluid; take Pedelec out of service if damaged; new brake hoses
Brake linings	6 months	Check brake linings, brake discs and rims for damage			O.K.	Damage detected	New brake linings, brake discs and rims
Back-pedal brake braking armature	6 months	Check mount fastening			O.K.	Loose	Retighten screws
Brake system	6 months	Check mount fastening		Functional check	O.K.	Loose	Retighten screws
Lighting system							
Rechargeable battery	6 months	First examination			O.K.	Error message	Contact battery manufacturer; take battery out of service; new battery
Light cabling	6 months	Connections, correct wiring			O.K.	Cable defective, no light	New cabling
Rear light	6 months	Side light	Functional check		O.K.	No constant light	New rear light as specified in parts list; replace if necessary
Headlight	6 months	Side light, daytime riding light	Functional check		O.K.	No constant light	New headlight light as specified in parts list; replace if necessary
Reflectors	6 months	All complete, state, fastening			O.K.	Damaged or not all complete	New reflectors
Drive/gear shift							
Chain/cassette/sprocket/chainring	6 months	Check for damage			O.K.	Damage	Refasten if necessary or replace as specified in parts list
Chain guard/spoke guard	6 months	Check for damage			O.K.	Damage	Replace as specified in parts list
Bottom bracket axle/crank	6 months	Check mount fastening			O.K.	Loose	Retighten screws
Pedals	6 months	Check mount fastening			O.K.	Loose	Retighten screws
Shifter	6 months	Check mount fastening	Functional check		O.K.	Loose	Retighten screws
Shift cables	6 months	Check for damage	Functional check		O.K.	Loose and defective	Adjust shift cables; new shift cables if necessary
Front derailleur	6 months	Check for damage	Functional check		O.K.	Switching gears difficult or not possible	Adjust
Rear derailleur	6 months	Check for damage	Functional check		O.K.	Switching gears difficult or not possible	Adjust



Component	Frequency	Description			Criteria		Measures if rejected
		Inspection	Test		Acceptance	Rejection	
Electric drive system							
On-board computer	6 months	Check for damage	Functional check		O.K.	No screen, defective screen display	Restart; test battery; new software or new on-board computer; take out of service
Control panel	6 months	Check control panel for damage	Functional check		O.K.	No response	Restart; contact control panel manufacturer, new control panel
Tachometer	6 months		Speed measurement		O.K.	Pedelec travelling 10% too fast/slow	Take pedelec out of service until the source of the error is found
Cabling	6 months	Visual inspection			O.K.	Failure in system, damage, kinked cables	New cabling
Battery mount	6 months	Firmly in position, lock, contacts	Functional check		O.K.	Loose; lock doesn't close, no contacts	New battery mount
Motor	6 months	Visual inspection and mount			O.K.	Damage, loose	Refasten motor, contact motor manufacturer, new motor; <i>take out of service</i>
Software	6 months	Check version			In latest version	Not latest version	Import update

Technical inspection, checking safety, test ride

Component	Frequency	Description			Criteria
		Inspection	Test		Acceptance
Brake system	6 months	Functional check	O.K.	No full braking; braking distance too long	Locate defective part in brake system and correct
Gear shift under operating load	6 months	Functional check	O.K.	Problems when shifting gear	Readjust gear shift
Suspension components (fork, shock absorber, seat post)	6 months	Functional check	O.K.	Suspension too deep or no longer exists	Locate defective component and correct
Electric drive	6 months	Functional check	O.K.	Loose connection, problems when riding, accelerate	Locate faulty component in electric drive and remedy
Lighting system	6 months	Functional check	O.K.	No continuous light, not bright enough	Locate defective part in lighting system and correct
Test ride	6 months	Functional check	No strange noises	Strange noises	Locate source of noise and correct

Date:	
Fitter's name:	
Final inspection by workshop manager:	



Notes

12 Glossary

Bicycle for young adults

Source: ISO 4210-2: bicycle designed for use on public roads by a young adult whose weight is less than 40 kg, with maximum saddle height of 635 mm or more and less than 750 mm. (see ISO 4210).

Brake lever

Source: EN 15194:2017: lever used to apply the brake.

Braking distance

Source: EN 15194:2017: distance travelled by a pedelec between the commencement of braking and the point at which the pedelec comes to rest.

Cargo bike

Source: DIN 79010: bicycle mainly designed to carry goods.

CE marking

Source: Directive on Machinery: the manufacturer uses the CE marking to declare that the pedelec complies with the applicable requirements.

City and trekking bicycle

Source: ISO 4210-2: bicycle designed for use on public roads primarily for means of transportation or leisure.

Consumables

Source: EN 82079-1: any part or material that is needed to continue using or maintain the product.

Continuous power rating

Source: ISO 15194:2017, output power specified by the manufacturer at which the motor reaches its thermal equilibrium under the specified ambient conditions.

Decommissioning

Source: DIN 31051: intentional, unlimited interruption in an object's functional capability.

Disc brake

Source: EN 15194:2017: brake in which brake pads are used to grip the lateral faces of a thin disc attached to or incorporated into the wheel hub.

Drive belt

Source: EN 15194:2017: seamless ring belt which is used as a means of transmitting drive force.

Electrical control system

Source: EN 15194:2017: electronic and/or electrical component or an assembly of components provided for installation into a vehicle, together with all electrical connections and associated wiring for the motor electrical power assistance.

Electrically power assisted cycle, pedelec

Source: EN 15194:2017: electrically power assisted cycle pedelec EPAC bicycles, equipped with pedals and an auxiliary electric motor, which cannot be propelled exclusively by means of the auxiliary electric motor, except in start-up assistance mode.

Emergency stop

Source: ISO 13850:2015, function or signal, designed: — to avert arising or reduce existing hazards to persons, damage to machinery or to work in progress; – to be initiated by a single human action.

Fault

Source: EN 13306:2018-02, 6.1: state of an item (4.2.1) characterized by its inability to perform a required function (4.5.1), excluding such inability during preventive maintenance or other scheduled actions or due to lack of external resources.

Folding bicycle

Source: EN-ISO 4210-2: bicycle designed to fold into a compact form, facilitating transport and storage.

Fork steerer

Source: EN 15194:2017: part of a fork that rotates around the steering axis of a pedelec frame head tube. It is normally connected to the fork crown or directly to the fork legs, and is normally the point of connection between the fork and the handlebar stem.

Fracture

Source: EN 15194:2017: unintentional separation into two or more parts.

Maintenance

Source: DIN 31051: maintenance is generally performed at regular intervals and often carried out by trained technical staff. This ensures a maximum service life and low wear and tear for the maintained items. Proper maintenance is often also a pre-requisite for providing a warranty.

Manufacturer

Source: Directive 2006/42/EC on Machinery, 17.05.2006 Any natural or legal person who designs and/or manufactures machinery or partly completed machinery covered by this Directive and is responsible for the conformity of the machinery or the partly completed machinery with this Directive with a view to its being placed on the market, under his own name or trademark or for his own use.

Maximum continuous power rating

Source: ZEG: the maximum continuous power rating is the maximum power for the electric motor output shaft during 30 minutes.

Maximum permitted total weight

Source: EN 15194:2017: weight of the fully assembled pedelec plus the rider and baggage, as specified by the manufacturer.

Maximum saddle height

Source: EN 15194:2017: vertical distance from the ground to the point where the top of the seat surface is intersected by the seat-post axis, measured with the saddle in a horizontal position and with the seat-post set to the minimum insertion-depth mark.

Maximum tyre pressure

Source: EN 15194:2017: maximum tyre pressure recommended by the tyre or rim manufacturer for a safe and efficient performance. If the rim and tyre both indicate a maximum tyre pressure, the maximum inflation pressure is the lower of the two pressures indicated.

Minimum insertion depth

Source: EN 15194:2017: mark indicating the minimum insertion depth of handlebar stem into fork steerer (fork stem) or seat post into frame.

Model year

Source: ZEG: the model year refers to the first production year that the series-manufactured pedelec was manufactured in the version in question and is not always identical with the year of manufacture. The year of manufacture may be before the model year in some cases. If no technical modifications are introduced to the series, production may continue of pedelecs from a previous model year.

Mountain bike, MTB

Source: ISO 4210-2: bicycle designed for use off-road on rough terrain, on public roads, and on public pathways, equipped with a suitably strengthened frame and other components, and, typically, with wide-section tyres with coarse tread patterns and a wide range of transmission gears.

Negative deflection

Negative deflection or sag is fork compression caused by body weight and gear (e.g. a backpack), the rider's position and the frame geometry.

Off-road rough terrain

Source: EN 15194:2017: rough gravel tracks, forest trails and other generally off-road tracks where tree roots and rocks are likely to be encountered.

Operating instructions

Source: ISO/DIS 20607:2018: part of the user information that machine manufacturers provide to machine operators; it contains guidance, instructions and tips related to the use of the machine in all its life cycle phases.

Placing on the market

Source: Directive 2006/42/EC on Machinery, 17.05.2006, Making available for the first time in the Community machinery or partly completed machinery with a view to distribution or use, whether for reward or free of charge.

Pressure point

Source: ZEG: the pressure point on a brake is the point on the brake lever where the brake disc and brake pads respond and the braking process is initiated.

Quick-release device, quick release

Source: EN 15194:2017: lever actuated mechanism that connects, retains or secures a wheel or any other component.

Racing bicycle

Source: ISO 4210-2: bicycle designed for amateur rides at high speed and for use on public roads having a control and steering assembly with multiple grip positions to provide an aerodynamic posture, a multi-speed transmission system and a tyre width not greater than 28 mm with the fully assembled bicycle having a maximum mass of 12 kg.

Rebound

The rebound defines the speed at which the fork rebounds after being loaded.

Rechargeable battery, battery

Source: DIN 40729:1985-05: a rechargeable battery is an energy storage device that can store supplied electrical energy as chemical energy (charging) and release it as electrical energy when required (discharging).

Seat post

Source: EN 15194:2017: component that clamps the saddle (with a bolt or assembly) and connects it to the frame.

Shut-off speed

Source: EN 15194:2017: speed reached, by the pedelec, at the moment the current has dropped to zero or to the no load current value.

Slippage

Source: DIN 75204-1:1992-05: the difference in relation to vehicle speed between the vehicle speed and the speed of its wheels at their circumference.

Spare part

Source: EN 13306:2018-02, 3.5: item intended to replace a corresponding item in order to retain or maintain the original required function of the item.

Suspension fork

Source: EN 15194:2017: front wheel fork incorporating controlled, axial flexibility to reduce the transmission of road-shocks to the rider.

Suspension frame

Source: EN 15194:2017: frame incorporating controlled, vertical flexibility to reduce the transmission of road-shocks to the rider.

Total deflection

Source: Benny Wilbers, Werner Koch: Neue Fahrwerkstechnik im Detail (New chassis technology in detail): The distance that the wheel travels between an unloaded and a loaded position is called total deflection. When at rest, the vehicle's mass is applied to the springs and reduces the total deflection by the *negative deflection* to the positive deflection.

Wear

Source: DIN 31051: reduction in useful life (4.3.4), caused by chemical and/or physical processes.

Weight of the ready-to-ride pedelec

Source: ZEG: the indicated weight for a ready-to-ride pedelec refers to the weight of a pedelec at the time of sale. The weight of each additional accessory must be added to this weight

Wheel

Source: ISO 4210 - 2: unit or combination of hub, rim and spokes or disc, but excluding tyre assembly.

Work environment

Source: ISO 9000:2015: set of conditions under which work is performed.

Year of manufacture

Source: ZEG: the year of manufacture is the year in which the pedelec was manufactured. The production period is always from May to July the following year.

12.1 Abbreviations

Abbreviation	Meaning/derivation
ABS	Anti-blocking system
BLE	Bluetooth Low Energy
EPAC	Electric power-assisted cycle
PTW	Permitted total weight

Table 141: Table of abbreviations

12.2 Simplified terms

The following terms are used for better legibility:

Term	Meaning
Operating instructions	Original operating instructions
Damper	Rear frame damper
Specialist dealer	Bicycle specialist dealer
Motor	Drive motor, sub-system
Belt drive	Toothed belt drive

Table 142: Table of simplified terms

13 Appendix

I. Translation of the original EC/EU Declaration of Conformity

Manufacturer	Authorised representative for documentation*
ZEG Zweirad-Einkaufs-Genossenschaft eG Longericher Strasse 2 50739 Köln Germany	c/o ZEG Zweirad-Einkaufs-Genossenschaft eG Longericher Strasse 2 50739 Köln Germany

The machine, pedelec types:

ZA-15-0017	Vuca Evo X1	City and trekking bicycle
ZA-15-0018	Vuca Evo FSX1	City and trekking bicycle

Year of manufacture 2022 to year of manufacture 2025, complies with the following applicable EU provisions:

- Machinery Directive 2006/42/EC
- RoHS Directive 2011/65/EU Restriction of the use of certain hazardous substances in electrical and electronic equipment
- Electromagnetic Compatibility Directive 2014/30/EU.

The safety objectives in the Low Voltage Directive 2014/35/EU have been met in compliance with Appendix I, No. 1.5.1 of the Machinery Directive 2006/42/EC.

The following harmonised standards have been applied:

- EN 15194:2017 Cycles – Electrically power assisted cycles – EPAC bicycles
Except Section 6 Instructions for Use; harmonised standard EN ISO 20607:2019 used in its place
- EN ISO 20607: 2019 Safety of machinery – Instruction handbook – General drafting principles.

The following other technical standards have been applied:

- EN 11243:2016-12 Cycles – Pannier racks for bicycles – Requirements and test methods
- EN 17406:2021-11 Classification for bicycles usage
- EN 62133-2:2017-11 Secondary cells and batteries containing alkaline or other non-acid electrolytes. Safety requirements for portable sealed secondary cells, and for batteries made from them, for use in portable applications – Part 2: Lithium.



Cologne, 20.10.2023

.....
Egbert Hageböck, Chairman, ZEG Zweirad-Einkaufs-Genossenschaft eG

* Community member who is authorised to compile the technical documentation

14 Keyword index

- A**
- Air valve, 35
 - position, 35
 - Articulated shaft,
 - maintain 167
 - Axle,
 - torque, 201
- B**
- Back-pedal brake,
 - brake, 144
 - Backsweep 33
 - Ball bearings,
 - position, 45
 - Basic cleaning 159
 - Battery,
 - charge, 133
 - check, 75
 - clean, 159
 - dispose, 245
 - ship, 72
 - store, 73
 - transport, 72
 - wake, 133
 - torques, 201
 - Battery, see rechargeable battery
 - Bead core, 43
 - position, 41
 - Bell,
 - check 157
 - use 136
 - position 55
 - Belt guard 16
 - Belt sprocket, 52
 - Belt, 52
 - check belt for wear 176
 - check tension 176
 - clean, 163
 - Gates Carbon Drive mobile app 177
 - Bicycle for young adults, 253
 - Bike headset, see steering headset
 - Bluetooth,
 - display connected devices 62
 - Bowden cable, 46
 - check, 174
 - Brake cable, 46
 - torque, 202
 - Brake calliper, 47
 - position, 47
 - torque, 202
 - Brake disc, 47
 - check, 175
 - clean 162
 - replace, 243
 - position, 47
 - Brake lever, 47
 - adjust pressure point, 108
 - service, 169
 - Brake linings, 47
 - check, 175
 - replace, 243
 - retract, 106
 - position, 47
 - torque, 202
 - Brake, 24
 - check brake disc, 175
 - check brake linings, 175
 - check pressure point, 174
 - check, 157, 174
 - clean, 158
 - secure during transport, 71
 - using, 144
 - cable clip, 46
 - cover cap, 46
 - hydraulic, 46
 - insert pin, 46
 - knob, 46
 - mechanical, 46
 - union nut, 46
 - Braking distance, 253
 - Break in operation, 73
 - carry out, 73
 - prepare, 73
 - Buttons,
 - On-Off (battery), 70
- C**
- Cantilever brake,
 - torque, 203
 - Carbon seat post,
 - maintain, 166
 - Carbon suspension fork,
 - inspect, 198
 - Carcass, 42
 - position, 41
 - Cargo bike, 253
 - Cassette,
 - clean, 162
 - CE marking, 253
 - Chain guard 16
 - Chain guard,
 - clean, 163
 - torques 206
 - Chain stay, 27
 - Chain wheel, 52
 - Chain wheels,
 - clean, 162
 - Chain, 52
 - clean, 163
 - maintain 168
 - replace, 243
 - service, 212
 - tension, 243
 - position, 52
 - Chainring brake,
 - torque, 205
 - Charger, 53
 - dispose, 245
 - store, 73
 - Chassis, 27
 - Child seat, 127
 - City and trekking bicycles, 253
 - Clamping force,
 - adjust quick release 79
 - check quick release, 79
 - Clock,
 - setting 62
 - Compression damping, 38
 - Consumables, 253
 - Continuous power rating 253
 - Control panel,
 - clean, 159, 161
 - Conventional valve, see Dunlop valve
 - Crank bearing,
 - torque, 206
 - Crank set,
 - torque, 206
 - Crown, 40
- D**
- Date,
 - setting 62
 - Decommissioning, 253
 - Derailleur gears,
 - check 181
 - Disc brake, 253
 - torque, 202
 - Display,
 - charge battery, 122
 - Down tube, 27
 - Drive belt, 253
 - Drive system, 52
 - switch on, 142, 143
 - switching on, 141

electric, 53
 Dual pivot rim brake,
 torque, 203
 Dunlop valve, see conventional
 valve
 Dust seal, 40

E

Electrical control system, 253
 Emergency stop 253
 Emergency stop system 17

F

Factory settings,
 - resetting 62
 Fault, 253
 Folding bicycle, 253
 Fork lock,
 position 55
 Fork steerer 254
 Fork steerer, 40
 Fork,
 - check 156
 - maintain, 158
 position, 24
 suspended, 255
 Fracture, 254
 Frame, 27
 27
 - check 156
 - clean, 160
 - inspect, 195
 - maintain, 158, 164
 carbon frame, 27
 position, 24
 Freewheel,
 torque, 203
 French valve, see Presta valve
 Front derailleur,
 - clean, 162
 torque, 210
 Front light, 53
 position, 24
 Front wheel brake,
 - brake, 144
 Front wheel, see Wheel

G

Gear hub,
 - inspect, 196
 Gear shift,
 - adjust dual-cable, Bowden-
 cable-operated twist grip
 shifter 182
 - check 181

- check electric gear shift,
 181
 - switch gears, 150
 Guard,
 position, 24
 Guards,
 - check 156

H

Handbrake, 253
 position 55
 torque, 205
 Handlebars, 33
 - check, 82, 180
 - clean, 160
 - maintain, 165
 - use 136
 - use bar ends 137
 - use multi-position
 handlebars 136
 position, 24
 rise 33
 torque, 206
 width 33
 Handles,
 - check 157
 - clean 160
 - maintain, 166
 - use leather handles 137
 position, 55
 Head tube, 27
 Headlight,
 - adjust, 121
 - check, 179
 - clean 158
 torque, 210
 Headlight, see Front light
 Headset, see steering headset
 Hub axle,
 position, 45
 Hub body,
 position, 45
 Hub gear,
 - check 181
 Hub, 45
 - adjust ROHLOFF 182
 - clean, 161
 - maintain 167
 - service 186
 hub, 24
 position, 41
 torque, 207
 without additional features,
 45
 Hydraulic brake system,
 - check 174

I

Initial commissioning, 75

J

Jockey wheel,
 - maintain 167

K

Kickstand,
 - clean, 160
 - maintain, 165
 - stability 183

L

Language,
 - selecting 62
 Leather handles,
 - clean 160
 - maintain, 166
 Leather saddle,
 - clean, 161
 - maintain, 166
 Level of assistance, 58, 133, 142
 - select 143
 - select, 143
 LIMOTEC seat post,
 - fit 76
 Lockout,
 position 55

M

Maintenance, 254
 Manufacturer, 254
 Mechanical,
 - gear shift 181
 Minimum insertion depth
 marking, 97
 Minimum insertion depth, 254
 Model year, 254
 Motor cover 16
 Motor cover,
 torques, 207
 Motor, 53
 - clean, 159
 torques 206
 Mountain bike, 254
 Mountain bike, see MTB
 MTB, see mountain bike
 Mudguard 16
 Mudguard,
 - clean, 160
 - maintain, 165
 Mudguards,
 - check, 156

- N**
 Negative deflection, 254
 Nipple holes,
 - check, 173
 Nipple well,
 - check, 173
- O**
 Off-road tyres, 42
 On-board computer,
 - attach, 122
 - clean 159
 - insert 122
 - remove 122
 - remove, 122
 - secure 122
 - store, 73
 torques, 201
 Operating instructions, 255
- P**
 Pannier rack,
 - care 165
 - change, 135
 - check 156
 - clean, 160
 - inspect, 195
 - use, 134
 position, 24
 Patent seat post, 50
 Pedal,
 - clean, 158
 - maintain, 167
 torque, 209
 Pedelec, 253
 - adjust 90
 - after each ride, 158
 - assemble 74
 - before each ride 131, 156
 - check, 170
 - clean 159
 - commission 75
 - initial inspection 184
 - inspect (specialist dealer)
 184
 - major inspection 184
 - sell, 82
 - service 164
 - ship, 72
 - store, 73
 - transport, 71
 - unpacking 74
 - use 134
- Placing on the market, 255
 -Position, 24
 Position, 24
 Pressure point, 255
 Puncture protection belt, 43
 position, 41
 Push assist,
 - use 142
- Q**
 Quick release, 255
 - inspect, 197
 position, 45
 Quick releases,
 - check 156
 Quickly adjustable 32
- R**
 Racing bicycle valve, see Presta
 valve
 Racing bicycle, 255
 Rear derailleur,
 - maintain, 167
 - position 52
 torque, 210
 Rear frame damper,
 - adjust rebound damper,
 118
 - adjust threshold, 140
 - check 156
 - clean 158
 - inspect, 195
 - maintain, 186, 195
 -adjust sag, 112
 structure, 29, 31
 Rear frame fork end, 27
 Rear frame seat stay, 27
 Rear light, 53
 - clean 158
 position, 24
 Rear wheel brake, 47
 Rear wheel, see Wheel
 Rebound adjuster, 35
 position, 35
 Rebound damping, 36
 Rebound, 255
 Rechargeable battery, 255
 Rechargeable battery, see
 battery
 Reflector,
 position, 24
 Reflectors,
 - clean 158
 Riding light
 - switch on 142
- Riding light,
 - adjust, 121
 - check, 157, 179
 - switch off 142
 Rim brake locking lever 46
 Rim, 43
 - replace, 243
 position, 41
 Rims,
 - maintain, 166
 Road tyres, 42
 Roller brake,
 - brake, 144
- S**
 Saddle, 135
 - adjust hardness 95
 - change the seat length, 97
 - check 180
 - clean, 160
 - determine saddle height,
 96, 97
 - determine width 94
 - Select hardness 95
 - use, 135
 position, 24
 Sag setting wheel,
 position, 35
 Sag,
 setting wheel position 55
 setting wheel, 40
 Sclaverand valve, see Presta
 valve
 Screen,
 battery level indicator, 70
 Seat post remote control,
 position, 55
 Seat post, 24, 50, 255
 - check 157, 180
 - clean, 160
 - inspect, 199
 - maintain, 166
 - patent seat post 50
 - suspension seat post 50
 remote control torque, 203
 torque, 203
 Seat tube, 27
 Shifter,
 - clean, 162
 - maintain, 167
 position, 55
 torque, 209

Shut-off speed, 255
 Size, 27
 Slicks, 42
 Slippage, 255
 Spare part, 255
 Spoke nipples, 44
 - maintain, 167
 position, 41
 Spokes, 44
 - check, 173
 - replace 243
 position, 41
 Steering headset 32
 Steering headset,
 - grease, 196
 - inspect, 196
 position, 24
 Steering system, 32
 Stem, 32
 - adjust 134
 - check, 82, 180
 - clean, 160
 - inspect, 196
 - maintain, 165
 position, 24
 torque, 211
 Suspension fork, 33, 255
 - clean 158, 160
 - inspect, 198
 - maintain, 158, 164
 Suspension seat post 50
 Suspension seat post,
 - clean, 158
 - maintain, 166
 Switching element,
 - clean, 161
 System message, 63, 219

T

Top tube, 27
 Total deflection 255
 Trailer, 128
 Tread, 42
 position, 41
 Tube,
 - replace, 243
 Tyre design types, 41
 Tyre pressure, 41
 - change, 170
 - check, 170
 Tyre size, 41
 Tyre,
 position, 41
 Tyres, 41
 - check, 172
 - clean 161

Tyres,- Tube-type tyres 41

U

Underride guard,
 torque, 211
 Unit,
 - changing 62
 USB cover,
 - check 157

V

Valve, 41
 Dunlop valve, 43
 position, 41
 V-Brake brake,
 torque, 211
 Vehicle,
 technical data 21

W

Wear, 255
 Wheel, 24, 41, 256
 - check concentricity 156
 - check, 170
 - fit 77, 78, 81
 Winter break, see Break in
 operation
 Work environment, 256

Y

Year of manufacture, 256